

# GAS WATER HEATER

## WHiX49, LWHiX49, WHiCX56, LWHiCX56 (External)

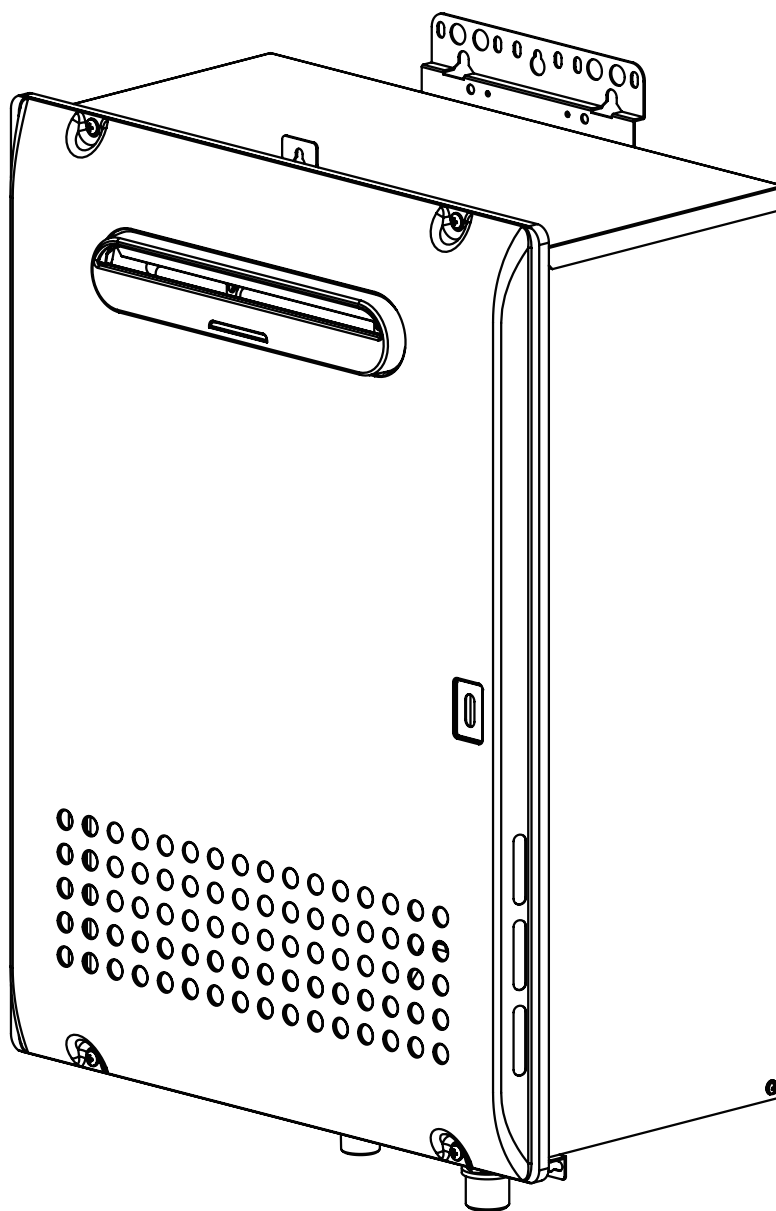

\*SBB80Z8\*

Please read and understand these instructions before commencing installation and leave this manual with the customer for future reference.

**Andrews. Built to perform.**



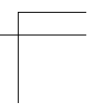
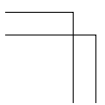
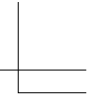
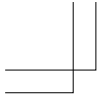

# Installation Manual

## GAS WATER HEATER

WHiX49, LWHiX49 (External)  
WHiCX56, LWHiCX56 (External)



**AGENT :**  
**ANDREWS WATER HEATERS**

Innovation House 3 Oaklands  
Business Centre Oaklands Park  
Wokingham Berkshire RG41 2FD, UK

**PRODUCT :**  
**NORITZ CORPORATION**  
5, Minamifutami, Futami-cho,  
Akashi, Hyogo, Japan

**WARNING:** If the information in this manual is not followed exactly, a fire or explosion may result causing property damage, personal injury or death.

Potential dangers from accidents during installation and use are divided into the following three categories. Closely observe these warnings, they are critical to your safety.

 <b>Danger</b>	Danger of serious injury or even death as well as danger of fire when the product is misused by ignoring this symbol.
 <b>Warning</b>	Possibility of serious injury or even death as well as possibility of fire when the product is misused by ignoring this symbol.
 <b>Caution</b>	Possibility of bodily injury or damage to property when the product is misused by ignoring this symbol.



Prohibited



Disconnect  
Power



Earth



Be sure to do

### Requests to Installers

 **Caution** • In order to use the water heater safely, read this installation manual carefully, and follow the installation instructions.

- Failures and damage caused by erroneous work or work not as instructed in this manual are not covered by the warranty.
- Check that the installation was done properly in accordance with this Installation Manual upon completion.
- After completion of installation, be sure to hand the Operation Manual to the customer upon filling in all of the required items.

- The appliance must be installed in accordance with the Gas Safety (Installation and Use) Regulations and the rules in force in the country of installation.
- The manufacturer's instructions supplied.
- The Gas Safety (Installation and Use) Regulations.
- The appropriate Buildings Regulations either The Building Regulations, The Building Regulations (Scotland), The Building Regulations (Northern Ireland).
- In IE, the installation must be carried out by a competent person and installed in accordance with the current edition of I.S.813 "Domestic Gas Installations", the current Building Regulations and reference should be made to the current ETCI rules for Electrical Installation.



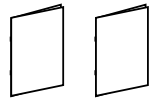

# 1. Included Accessories

The following accessories are included with the unit. Check for any missing items before starting installation.

Part	Shape	Q'ty	Part	Shape	Q'ty
Anchoring Screw		5	Owner's Guide, Installation Manual (this document)		1

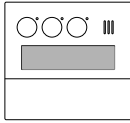
# 2. Optional Accessories

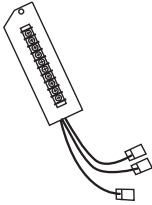
The accessories listed below are not included with the units, but may be necessary for installation.

Part	Shape	Q'ty	Part	Shape	Q'ty
Main Controller (RC-9018C)		1	Quick Connect Cord-2 (2m)		1
System Controller (SC-401-6M) for 1-6 units compatible with WHiCX56 series		1	System Controller (SCU-401-12M) for 1-6 units compatible with WHiX49 series		1

Item	Specification			
	WHiX49	LWHiX49	WHiCX56	LWHiCX56
Model Name	WHiX49	LWHiX49	WHiCX56	LWHiCX56
Flue Type	A <sub>3</sub>			
Category	II <sub>2H</sub> 3P			
Electrical Consumption	75.9W	75.9W	75.9W	75.9W
Gas Supply Pressure	G20 20mbar	G31 30/37mbar	G20 20mbar	G31 30/37mbar
Max.Burner Setting Pressure	6.5mbar	10.0mbar	6.9mbar	8.4mbar
Min.Burner Setting Pressure	3.1mbar	3.6mbar	3.2mbar	3.7mbar
Max.Water Pressure	10.0bar	10.0bar	10.0bar	10.0bar
Min.Water Pressure	1.0bar	1.0bar	1.0bar	1.0bar
Max.Heat Output	49kW	49kW	56kW	56kW
Min.Heat Output	3.84kW	3.6kW	4.2kW	4.0kW
Max.Heat Input(NET)	53.5kW	53.5kW	53.5kW	54.5kW
Min.Heat Input(NET)	4.35kW	4.35kW	4.35kW	4.35kW
Destination Countries	GB&IE	GB&IE	GB&IE	GB&IE
IP Rate	IP24D			

# 3. Quick Connect Multi System Installation

- The Quick Connect Multi System allows the installation of two units together utilizing only the Quick Connect Cord-2.

The Quick Connect Cord-2 is 2m long. Install the units 50 - 457mm apart from each other to ensure the cord will be able to reach between the units. (See Typical Plumbing diagram). (If the distance between the two units is too great, not only will the cord not be able to reach, but the water temperature may also become unstable because of the difference in pipe length between the two units).

## System Diagram

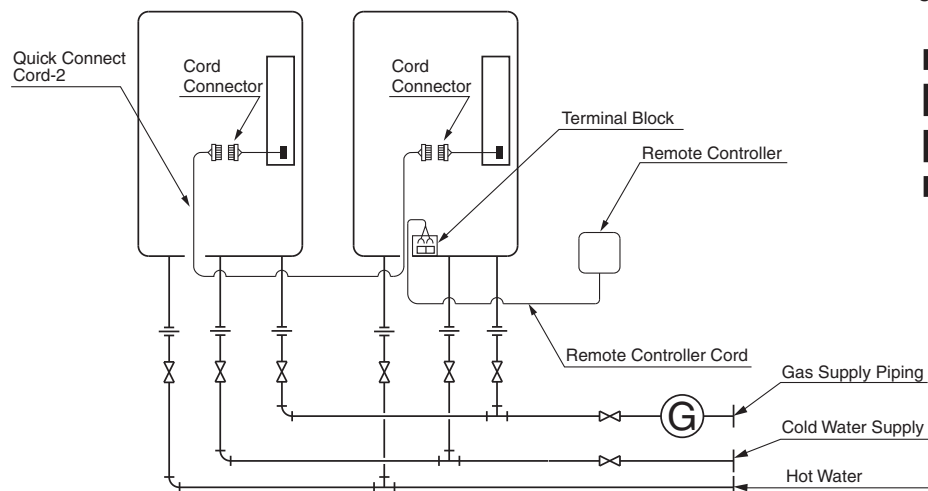

\* When connecting 2 devices, use only a single remote controller.

Note: Connect the remote controller to only one of the devices.

## Typical Plumbing

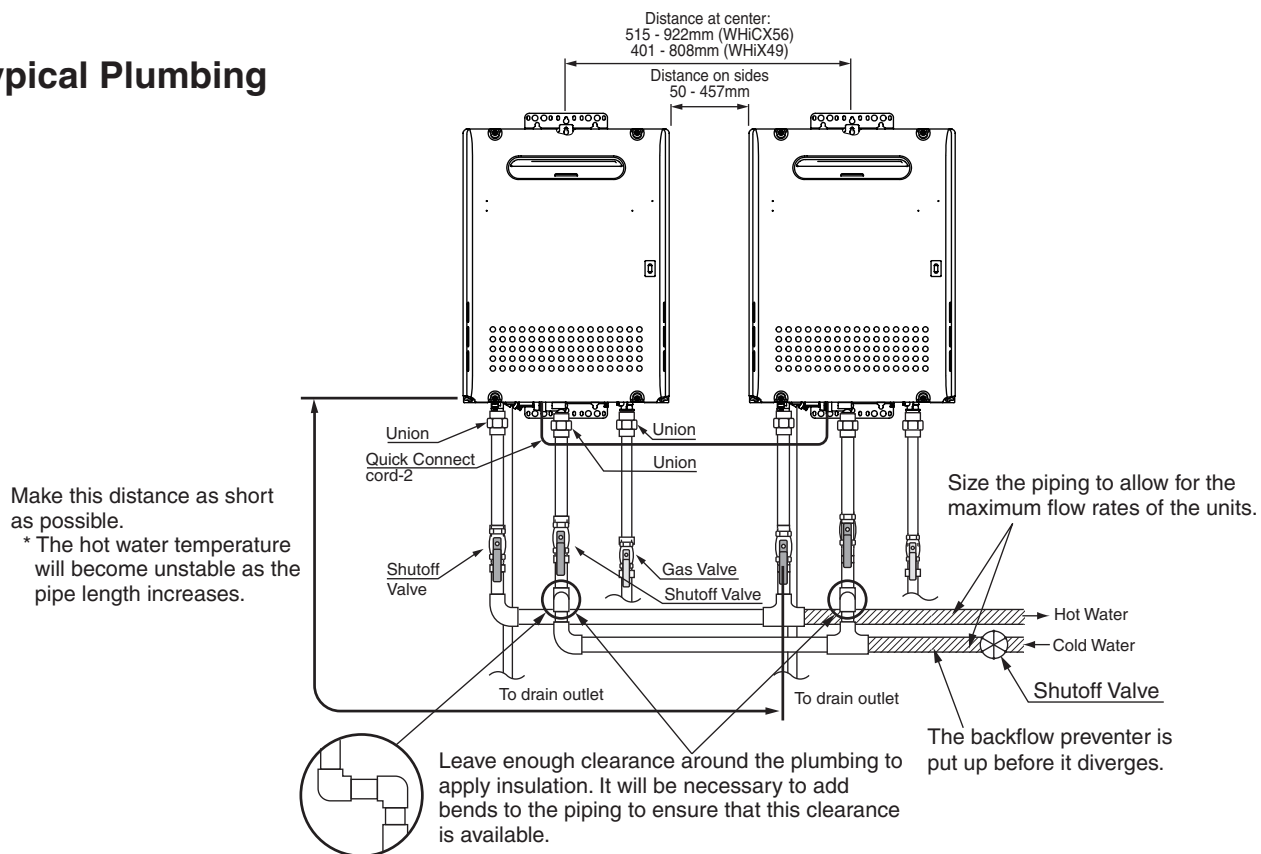

- Insulate the hot water piping to prevent heat loss. Insulate and apply heating materials to the cold water supply piping to prevent heat loss and freezing of pipes when exposed to excessively cold temperatures.

## 4. Before Installation



### Check the Gas

- Check that the rating plate indicates the correct type of gas.  
Check that the gas supply line is sized for 54.0 kW for this unit.

### Check the Power

- The power supply required is 220 - 240V AC, at 50Hz.  
Using the incorrect voltage may result in fire or electric shock.

### Do Not Use Equipment for Purposes Other Than Those Specified

- Do not use for purposes other than increasing the temperature of the water supply, as unexpected accidents may occur as a result.

### Check Water Supply Quality

- If the water supply is hard, acidic or otherwise impure, treat the water with approved methods in order to ensure full warranty coverage.

### Use Extreme Caution if Using With A Solar Pre-Heater

- Using this unit with a solar pre-heater can lead to unpredictable output temperatures and possibly scalding. If absolutely necessary, use mixing valves to ensure output temperatures do not get to scalding levels. Do not use a solar pre-heater with the quick-connect multi-system.

### Checkup

- Check the fixing brackets yearly for damage or wear. Replace if necessary.

## 5. Choosing Installation Site

\* Locate the appliance in an area where leakage from the unit or connections will not result in damage to the area adjacent to the appliance or to the lower floors of the structure. When such locations cannot be avoided, it is recommended that a suitable drain pan, adequately drained, be installed under the appliance. The pan must not restrict combustion air flow.

### Caution

- The water heater is designed for external installation only. Never install it indoors or in a bathroom.
- Consult with the customer concerning the location of installation.
- Avoid places where fires are common, such as those where gasoline, benzene and adhesives are handled, or places in which corrosive gases (ammonia, chlorine, sulfur, ethylene compounds, acids) are present.  
This may cause incomplete combustion or failures.
- Locate the water heater so that there are no obstacles around the termination and so that exhaust can't accumulate. Do not enclose the termination with corrugated metal or other materials.
- Install the water heater in an area that allows for the proper clearances to combustible and noncombustible construction. Consult the rating plate on the appliance for proper clearances.
- Do not install the water heater in a place where it may be threatened by falling objects, such as under shelves.
- Do not install the water heater where the exhaust will blow on outer walls or material not resistant to heat. Also consider the surrounding trees and animals.  
The heat and moisture from the water heater may cause discoloration of walls and resinous materials, or corrosion of aluminum materials.
- Avoid installation in places where dust or debris will accumulate. Dust may block the air-supply opening, causing the performance of the fan motor to drop and incomplete combustion to occur as a result.
- Install in a location where the exhaust gas flow will not be affected by fans or range hoods.
- Take care that noise and exhaust gas will not affect neighbors.
- Avoid installation in places where special chemical agents (e.g., hair spray or spray detergent) are used.  
Ignition failures and malfunction may occur as a result.

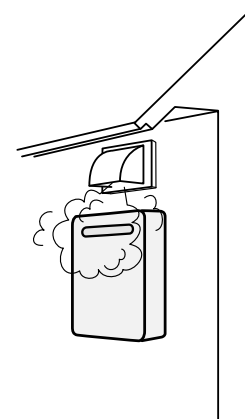
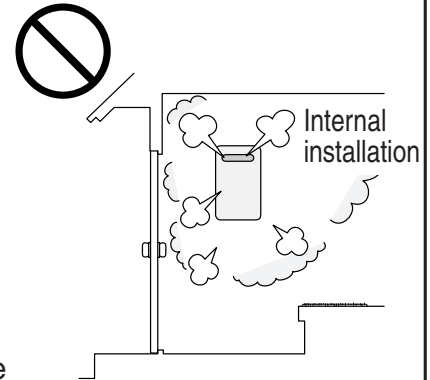

# 6. Installation Clearances

Before installing, check for the following:

Install in accordance with relevant building and mechanical codes, as well as any local, state or national regulations.

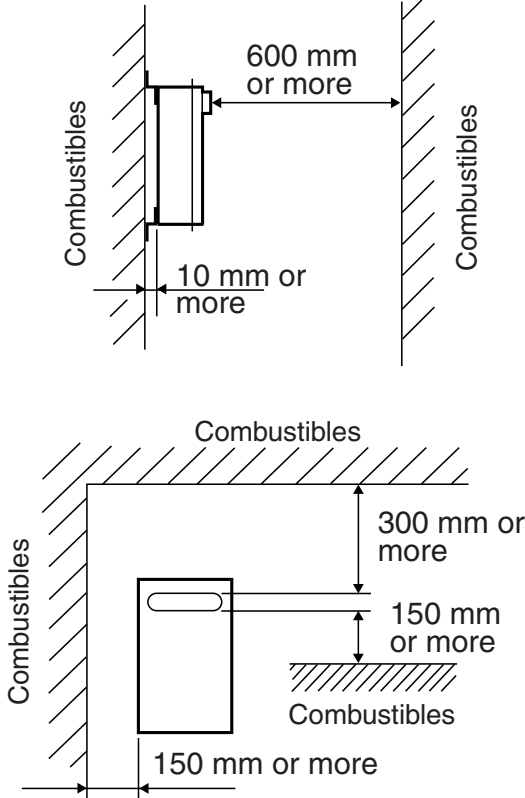
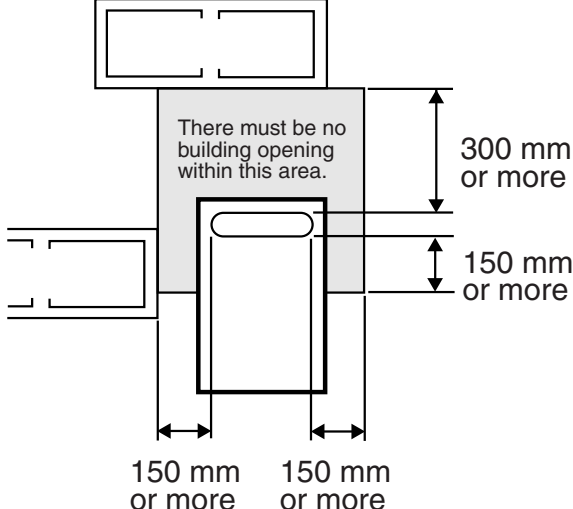
Item	Check	Illustration
Distance from combustibles	<ul style="list-style-type: none"> <li>Maintain the following clearances from both combustible and non-combustible materials.</li> </ul>	
Clearances to Opening into Any Building	<ul style="list-style-type: none"> <li>There must be a clearance of 600mm or more in front of the exhaust terminal.</li> <li>This restriction will not be applied to an area where an effective shield makes a clearance of 600mm or more in front of the exhaust outlet.</li> </ul>	



## FLUE REQUIREMENTS

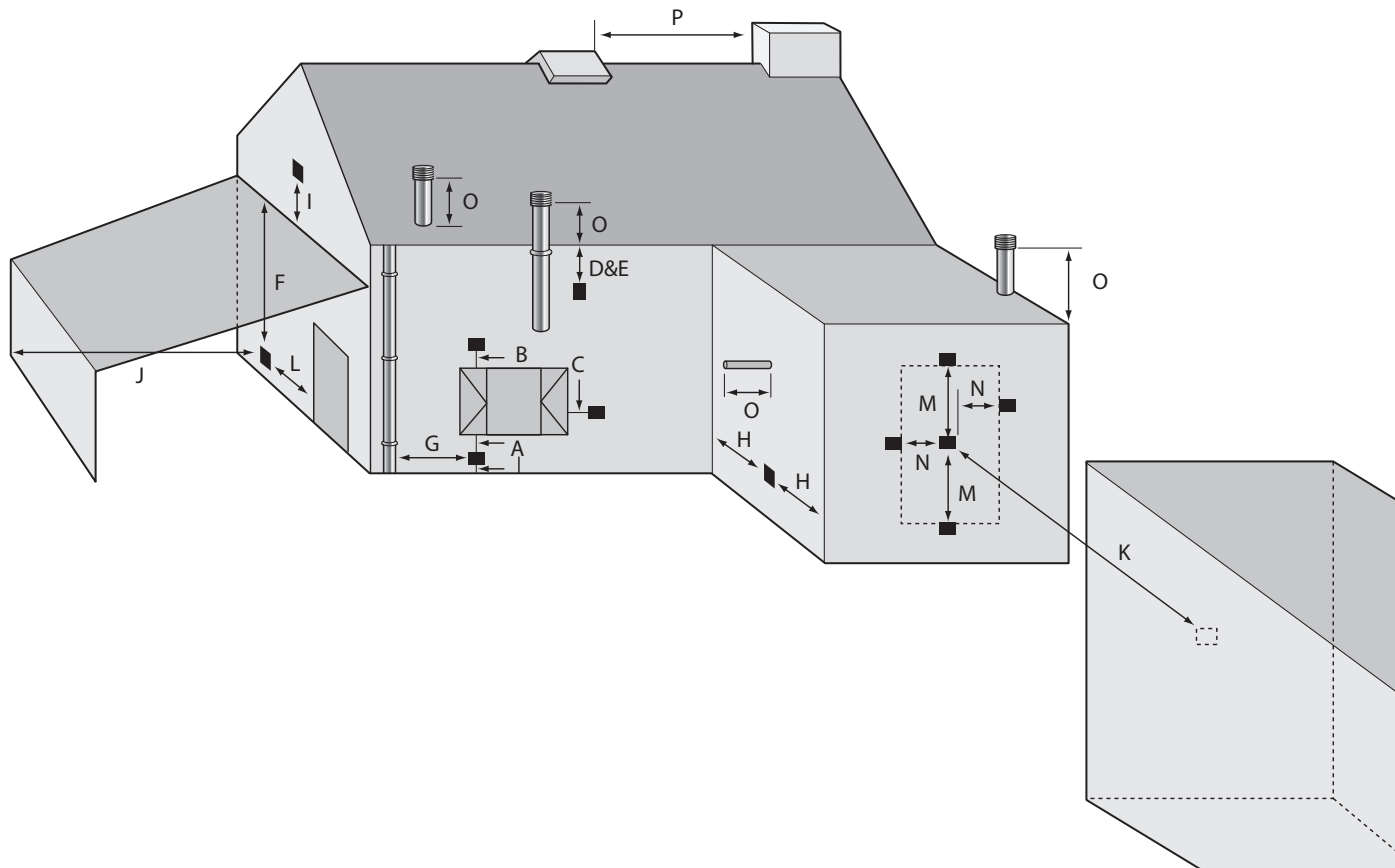

Symbol	Terminal Position	Dimension
A	Directly below an opening, air brick, opening windows, ect.	300mm
B	Above an opening, air brick, opening window, ect.	300mm
C	Horizontally to an opening, air brick, opening window, ect.	300mm
D	Below plastic gutters, soil pipes, drain pipes, ect.	75mm
E	Below eaves	200mm
F	Below balconies or car port roof	200mm
G	From vertical drain pipe or soil pipe	150mm
H	From and internal or external corner	300mm
I	Above ground, roof or balcony level	300mm
J	From surface facing the terminal	600mm
K	From terminal facing terminal	1200mm
L	From opening in the car port (eg door, window ect) into the dwelling	1200mm
M	Vertically from terminal on the same wall	1500mm
N	Horizontally from terminal on the same wall	300mm
O	From the wall on which the terminal is mounted	0
P	From a vertical structure on the roof	N/A
Q	Above intersection with the roof	300mm

# 7. Installation

## Securing to the wall



- The weight of the device will be applied to the wall. If the strength of the wall is not sufficient, reinforcement must be done to prevent the transfer of vibration.
- Do not drop or apply unnecessary force to the device when installing. Internal parts may be damaged and may become highly dangerous.
- Install the unit on a vertical wall and ensure that it is level.

Item	Check	Illustration						
Locating Screw Holes	<div style="border: 1px solid black; padding: 5px; margin-bottom: 10px;"> <b>Caution</b> <ul style="list-style-type: none"> <li>When installing with bare hands, take caution to not inflict injury.</li> <li>Be careful not to hit electrical wiring, gas, or water piping while drilling holes.</li> </ul> </div> <ol style="list-style-type: none"> <li>1. Drill a single screw hole, making sure to hit a stud.</li> <li>2. Insert and tighten the screw and hang the unit by the upper wall mounting bracket.</li> <li>3. Determine the positions for the remaining four screws (two for the top bracket and two for the bottom), and remove the unit.</li> </ol>	<p style="text-align: center;">Location of Screw Hole</p>						
Mounting	<ol style="list-style-type: none"> <li>4. Drill holes for the remaining four screws.</li> <li>5. Hang the unit again by the first screw, and then insert and tighten the remaining four screws.</li> <li>6. Take waterproofing measures so that water does not enter the building from screws mounting the device.</li> </ol>	<p style="text-align: center;">Tapping Screw</p>						
Structure	<ul style="list-style-type: none"> <li>• Make sure the unit is installed securely so that it will not fall or move due to vibrations or earth-quakes.</li> </ul>							
Installations at Elevations Above 610m.	<ul style="list-style-type: none"> <li>• Adjust the dip switches as illustrated in the table to the right if this water heater is installed at an altitude of 610m or higher.</li> <li>• Disconnect power to the water heater before changing the dip switches. Failure to perform this step will result in a "73" code displayed on the operation panel and a cease in operation. If this occurs, disconnect, then reconnect power to the water heater to reset the system.</li> </ul>	<p>* Do not change any other dipswitches.</p> <table border="1" style="margin-left: auto; margin-right: auto;"> <tr> <td></td> <td style="text-align: center;">1</td> </tr> <tr> <td style="text-align: center;">0 - 610m</td> <td style="text-align: center;">○</td> </tr> <tr> <td style="text-align: center;">611 - 1,220m</td> <td style="text-align: center;">●</td> </tr> </table> <p style="text-align: center;">ON= ● OFF= ○</p>		1	0 - 610m	○	611 - 1,220m	●
	1							
0 - 610m	○							
611 - 1,220m	●							



### Terminal Guards

A terminal guard is required if persons could come into contact with the terminal or the terminal could be subject to damage.

If a terminal guard is required, it must be positioned to provide minimum of 50 mm clearance from any part of the terminal and be central over the terminal.

Part number: E528, Stainless Mesh Guard  
Manufacturer Details: KDS Engineering Limited  
Unit 7, Moor Street Industrial Estate  
Moor Street  
Brierley Hill  
West Midlands  
England  
DY5 3ST

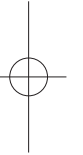

## 8. Gas Piping

Follow the instructions from the gas supplier.

The appliance and its individual shutoff valve must be disconnected from the gas supply piping system during any pressure testing of that system at test pressures in excess of 35 mbar.

The Appliance must be isolated from the gas supply piping system by closing its individual manual shutoff valve during any pressure testing of the gas supply piping system at test pressures equal to or less than 35 mbar.

The appliance and its gas connections must be leak tested before placing the appliance in operation.

The inlet gas pressure must be within the range specified. This is for the purposes of input adjustment.

### Measuring Gas Pressure

In order to check the gas supply pressure to the unit, a tap is provided on the gas inlet. Remove the hex head philips screw from the tap, and connect a manometer using a silicon tube.

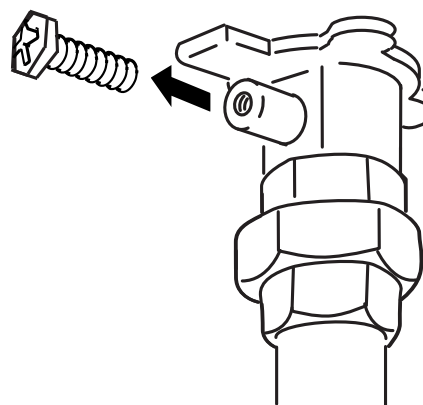

# 9. Water Piping

Ask a qualified plumber to perform the installation of the plumbing. Observe all applicable codes.

This appliance is suitable for potable water. Do not use this appliance if any part has been underwater. Immediately call a qualified service technician to inspect the appliance and replace any part of the control system and gas control which has been under water.

If the water heater is installed in a closed water supply system, such as one having a backflow preventer in the cold water supply line, means shall be provided to control thermal expansion. Contact ANDREWS WATER HEATERS TECHNICAL DEPARTMENT FOR ADVICE.

Piping and components connected to the water heater shall be suitable for use with potable water. Toxic chemicals, such as those used for boiler treatment, shall not be introduced into the potable water. A water heater used to supply potable water may not be connected to any heating system or components previously used with a nonpotable water heating appliance. When water is required in one part of the system at a higher temperature than in the rest of the system, means such as a mixing valve shall be installed to temper the water to reduce the scalding hazard.

- Flush water through the pipe to clean out metal powder, sand and dirt before connecting it.
- Take appropriate heat insulation measures (e.g., wrapping with heat insulation materials, using electric heaters) according to the climate of the region to prevent the pipe from freezing.
- Use a union coupling or flexible pipe for connecting the pipes to reduce the force applied to the piping.
- Do not use piping with a diameter smaller than the coupling.
- When feed water pressure is too high, insert a depressurizing valve, or take water hammer prevention measures.
- Avoid using joints as much as possible to keep the piping simple.
- Avoid piping in which an air holdup can occur.
- Use approved piping materials.
- If installing the unit on a roof:

If the unit is installed on a roof to supply water to the levels below, make sure that the water pressure supplied to the unit does not drop below 2000 mbar. It may be necessary to install a pump system to ensure that the water pressure is maintained at this level.

Check the pressure before putting the unit into operation.

Failing to supply the proper pressure to the unit may result in noisy operation, shorter lifetime of the unit, and may cause the unit to shut down frequently.

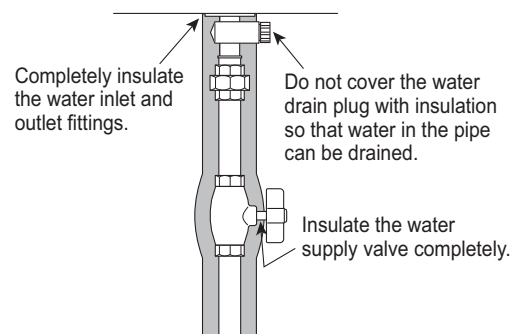

### Supply water piping

- Do not use PVC piping.
- Mount a check valve and a shut off valve (near the inlet).
- In order for the client to use the water heater comfortably, 1000 mbar to 5000 mbar of pressure is needed from the water supply. Be sure to check the water pressure. If the water pressure is low, the water heater cannot perform to its full capability, and may become a source of trouble for the client.

### Drain piping

- Expansion water may drop from the pressure prevention device and wet the floor. If necessary, provide drain piping or use a drain hose to remove the water.

### Hot water piping

- Do not use lead or PVC piping.
- The longer the piping, the greater the heat loss. Try to make the piping as short as possible.
- Use a mixing valve with a low water resistance. Use shower heads with low pressure loss.
- If necessary, use a pump or other means to ensure that the supply water pressure to the inlet of the heater does not fall below 2000 mbar when the maximum amount of water is being demanded. Also install a pressure meter on the inlet. If this is not done, local boiling will occur inside the water heater causing abnormal sounds and decreasing the durability of the heat exchanger.

### WATER QUARITY

If the heater is in a hard water area a suitable water conditioning device must be installed to prevent the build up of limescale within the heat exchanger. Heat exchangers damaged by scaling are not covered by the manufacturer's warranty.

Description	pH	Total Dissolved solids (TDS)	Total Hardness	Chlorides	Magnesium	Calcium	Sodium	Iron
Maximum Recommended Levels	6.5 - 9.0	500 mg/liter	150 mg/liter	250 mg/liter	10 mg/liter	20 mg/liter	180 mg/liter	1 mg/liter

# 10. Electrical Wiring

Consult a qualified electrician for the electrical work.



Do not connect electrical power to the unit until all electrical wiring has been completed.

- i) "A means of disconnection from the supply mains having a contact separation in all poles must be provided to allow for full disconnection".
- ii) Under voltage Cat III conditions should be incorporated in the fixed wiring in accordance with the wiring regulations.
- iii) "If the supply cord is damaged, it must be replaced by the manufacturer or its service agent".

This appliance must be electrically grounded in accordance with Electrical Authority Regulations.

External wiring must be correctly earthed, polarised and in accordance with the relevant standards.

In GB this is BS 6891.

In IE this is the current edition of I.S.813 "Domestic Gas Installations".

The boiler must be connected to a permanent 220 - 240 V ac, 50Hz supply.

Connection of the whole electrical system of the boiler, including any heating controls, to the electrical supply must be through one common isolator and must be fused 10 Amp maximum.

Isolation should be by a double pole switched fused spur box, with a minimum gap of 3 mm for both poles. The fused spur box should be readily accessible and preferably adjacent to the appliance. It should be identified as to its use.

**Caution:** Label all wires prior to disconnection when servicing controls. Wiring errors can cause improper and dangerous operation.

Verify proper operation after servicing.

Field wiring to be performed at time of appliance installation.



## Caution

Do not turn on the power until the electrical wiring is finished. This may cause electrical shock or damage to the equipment to occur.

- The electrical supply required by the water heater is 220 -240V AC at 50 Hz. The power consumption may be up to 135W. Use an appropriate circuit.
- Do not disconnect the power supply when not in use. When the power is off, the freeze prevention in the water heater will not activate, resulting in possible freezing damage.

- Do not let the power cord contact the gas piping.

Tie the redundant power cord outside the water heater. Putting the redundant length of cord inside the water heater may cause electrical interference and faulty operation.

## Ground

- To prevent an electric shock, always plug power lead into an earth powerpoint.

**THE APPLIANCE MUST BE EARTHED**

## Remote Controller

- Applicable Model

		WHiX49, LWHiX49, WHiCX56, LWHiCX56
Remote controller	Main	RC-9018M

- The remote controller must be installed in accordance with the installation manual enclosed in the package.

## Connecting Remote Controller Cord to Unit

- Keep the remote controller cord away from the freeze prevention heaters in the unit.
- Tie the redundant cord outside the water heater. Do not put the extra length inside the equipment.
- The remote controller cord can be extended up to 100m with Remote controller cord.
- Use a Y type terminal with a resin sleeve. (Without the sleeve, the copper wire may corrode and cause problems).
- Be sure to hand tighten when screwing to the terminal block. Power tools may cause damage to the terminal block.

## Remote controller cord

- Use Remote controller cord for any extensions.
- Install according to the National Electrical Code and all applicable local codes.

1. Disconnect electrical power to the water heater.
2. Leave enough slack so that the remote controller cord will not be damaged if the unit is removed from the wall.
3. Remove the front cover of the heater (4 screws).
4. Pass the remote controller cord through the wiring throughway and into the unit.
5. Connect the Y terminals at the end of the remote controller cord to the terminal block.
6. Secure the remote controller cord with a clamp.
7. Replace the front cover.

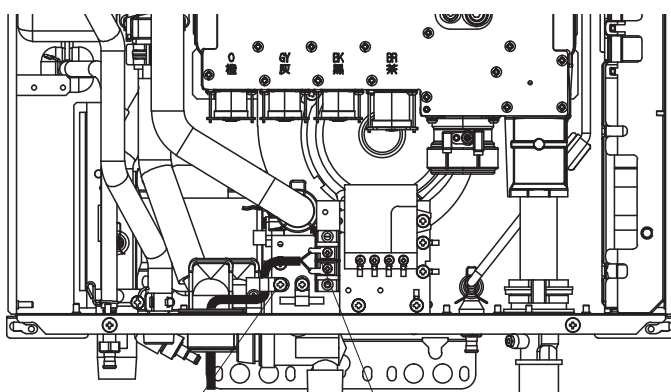

Clamp Remote Controller Terminal  
WHiCX56 series

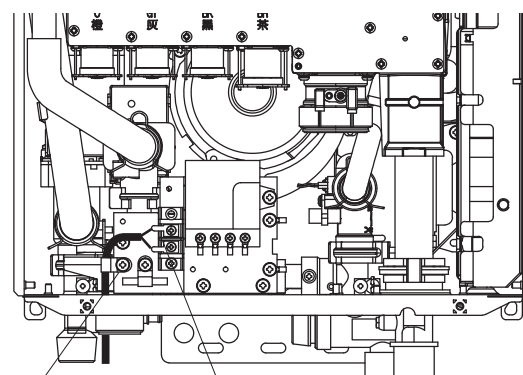

Clamp Remote Controller Terminal  
WHiX49 series

## Connecting Quick Connect Cord-2

For Quick Connect Multi System Installation use part Quick Connect Cord-2 only. (sold separately).

### Caution

The wire coloring on the Quick Connect Cord-2 will not be the same as the wire coloring of the connection plug inside the unit.

\* The remote controller can be connected to either unit A or B. Do not connect a remote controller to both units.

\* Disconnect the remote controller from either unit A or B prior to installing the Quick Connect Cord-2.

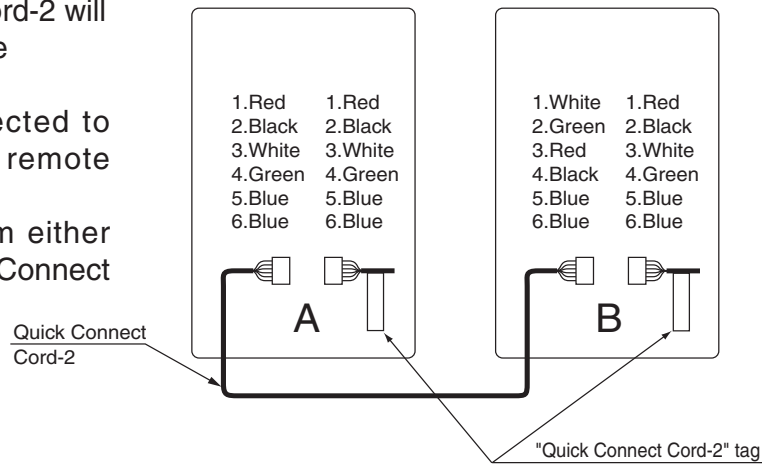

### Connecting the Quick Connect Cord-2 to the two units.

1. Turn off the power.
2. Remove the front cover of the heater (4 screws).
3. Pass the Quick Connect Cord-2 through the wiring throughway and into the unit.
4. Plug the connector on the Quick Connect Cord-2 to the receptacle inside the unit.
5. Attach the ground wire of the Quick Connect Cord-2 to the terminal block fixing plate. (If the ground wire is not attached, electrical noise may cause problems).
6. Secure the Quick Connect Cord-2 with a clamp.
7. Replace the front cover.

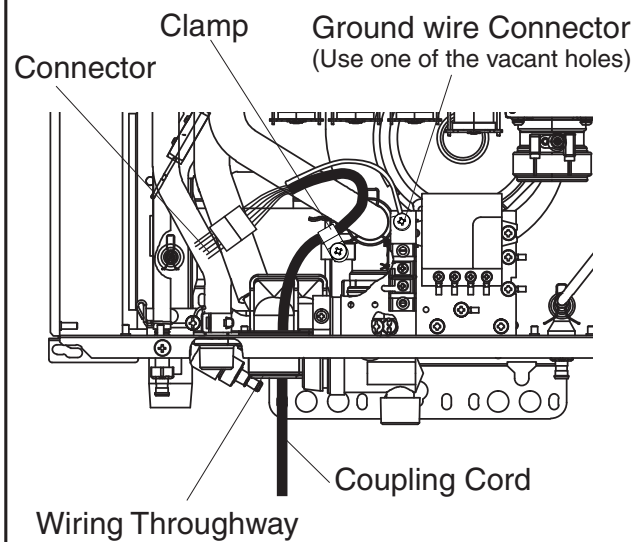



## Remote Controller

# Installation Guide

### Requests to Installers

- In order to use the water heater safely, read this installation guide carefully, and follow the installation instructions.
- Failures and damage caused by erroneous work or work not as instructed in this manual are not covered by the warranty.
- Refer to the Installation Manual provided with the water heater for complete installation details.

In order to use this product safely, read this installation manual carefully and follow the installation instructions.

- Potential dangers from accidents during installation and use are described below. Closely observe these warnings, they are critical to your safety.



### CAUTION

CAUTION indicates a potentially hazardous situation which, if not avoided, may result in minor or moderate injury.



### CAUTION

The remote controller is not water resistant. Keep it dry.



### CAUTION

- Do not connect power to the system unit until the remote controller installation is complete.
- Be sure to fasten the mounting screws tightly by hand so that the remote controller will be secure.
  - \* Do not use electric drivers, impact drivers and so forth. Tightening with excessive force may cause the mounting bracket to be damaged and lead to failures.
- Install the remote controller on an even wall surface.
  - \* Installing it on an uneven wall surface may cause the bracket to be damaged and lead to failures.
- This remote controller has a built-in speaker which can be damaged by metal shavings resulting in sound cracking.

Keep the remote controller in a safe location prior to mounting it on the wall to prevent metal shavings from entering the remote controller.

### Note

- Cutting too large of a hole on the wall may result in failure to properly secure the remote controller.
- Never fasten or loosen unnecessary screws in order to complete the remote controller installation.
- Be sure to check the positions of wall studs or other obstructions when determining the installation location for the remote controller.
- Secure the remote controller cable with appropriate anchors, ties, etc.
- Wire the remote controller cable in an area where it will not be directly affected by heat.
- To embed the remote controller cable in concrete, brick, etc., enclose it in conduit in order to prevent the remote controller cable from becoming damaged.
- When penetrating a wall containing metal lath, prevent the lath from coming into contact with any metallic conduit used in order to prevent electrical interference.
- Wiring shall be provided so that the remote controller cable length is 100m or shorter.
- Connect the remote controller cable to the terminal block of the water heater (see Installation Manual provided with the water heater).





### Post-installation Checks

- (1) Check if the remote controller is installed securely.
- (2) Verify remote controller operation (see OPERATING INSTRUCTIONS).
- \* Press the Power On/Off button approximately 5 seconds after connecting power to the system.
- \* Check if the temperature setting on the remote controller is appropriate.

### Explanation to the Customer

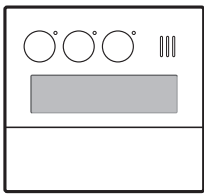
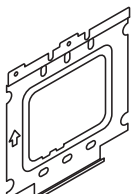
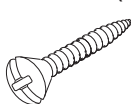
Explain the “Important Safety Information”, “Operation Procedures” and “Follow-up Service” according to the Owner's Guide supplied with the water heater.

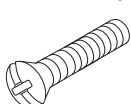
### Included Parts List (The value in ( ) indicates the quantity.)

Remote Controller	Mounting bracket	Raised countersunk head wood screw	Wall anchor	Raised countersunk head screw	Machine screw
(1)	(1)	(2)	(2)	(2)	(2)
				 (For junction box installation)	

### Confirmation before the setting

#### ■ Introduction

- Make sure that the power is not turned on (the breaker is “OFF” or the power plug of equipment is disconnected).
- Check the included parts list.

#### ■ Confirmation before the setting

- Choose a place that is easy to use in consultation with our customers (It is necessary to get the approval of the visitor).
- Do not be attached to the following place;
  1. The place where the temperature becomes higher (near a gas stove)
  2. The place where direct rays hit (near a window etc.)
  3. The place which requires steam (near a gas stove and a rice cooker etc.)
  4. The place which requires a spray (near a hot water tap etc.)
  5. The place which requires oil (near a gas stove)
  6. The place which uses chemical specialities (Benzine, Oils and fats system detergent etc.)

#### ■ Confirmation of the remote-control cord

The remote controller cord can be extended up to 100m. Please use the thing of required length according to the conditions of the spot.

By splicing the cord and using 18 gauge wire to extend the cord to the appropriate length. For using it, please be sure to attach Y-shaped terminal with a resin sleeve.

Be careful for a mustache not to come out.

When a mustache comes out, please be sure to reattach Y-shaped terminal. A mustache contacts other parts and causes failure of apparatus.

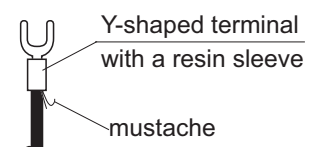

## Installation

1. Attach the mounting bracket to the wall.  
The parts to be used vary depending on the attachment method.

\* Never use electric drivers, impact drivers and so forth. Tightening with excessive force may result in deformation of the mounting bracket and/or failures.

<When attaching to a junction box>

- Use the raised countersunk head screws to attach the mounting bracket to the junction box. (In this case, the wall anchor and round countersunk head wood screws are not used.)

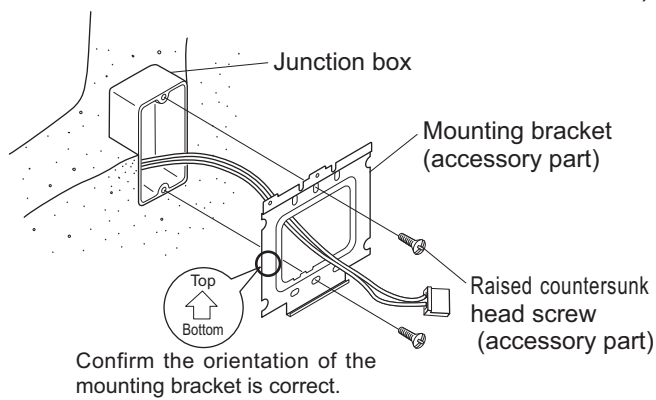

<When attaching to a wood surface>

- Use the raised countersunk head wood screws to attach the mounting bracket. (In this case, the wall anchor and raised countersunk head screws are not used.)

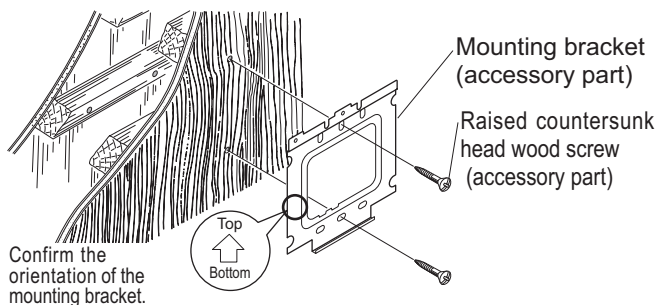

<When attaching to a concrete wall surface>

- Drill a  $\phi 6\text{mm}$  hole, approx. 25mm~30mm in depth, and hammer in the wall anchor. Attach the mounting bracket using the raised countersunk head wood screws. (In this case, raised countersunk head screws are not used.)

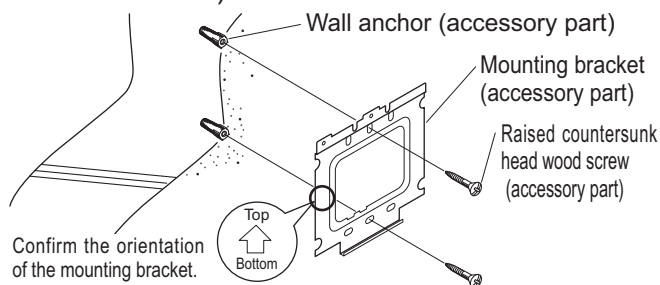

2. Remove the decorative frame from the remote controller.  
(The remote controller is inserted in the decorative frame.)

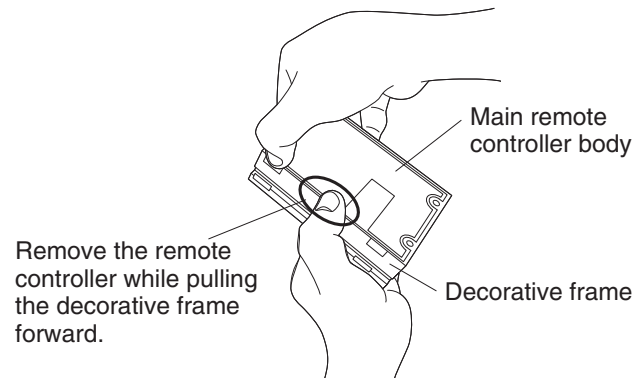

3. Connect a Y-shaped terminal of the remote control cord to a terminal stand of the remote control in back side.

Push down only section A (hatched) of an insulated cover (clear) to the front, and attach Y-shaped terminal from an insulated cover (clear) top side.

- \* Do not remove the insulating cover (clear).
- \* Be careful about the installation direction of the Y-shaped terminal.
- \* Do use an electric driver, the impact screwdriver absolutely. The position of a terminal stand changes with kinds of remote control.

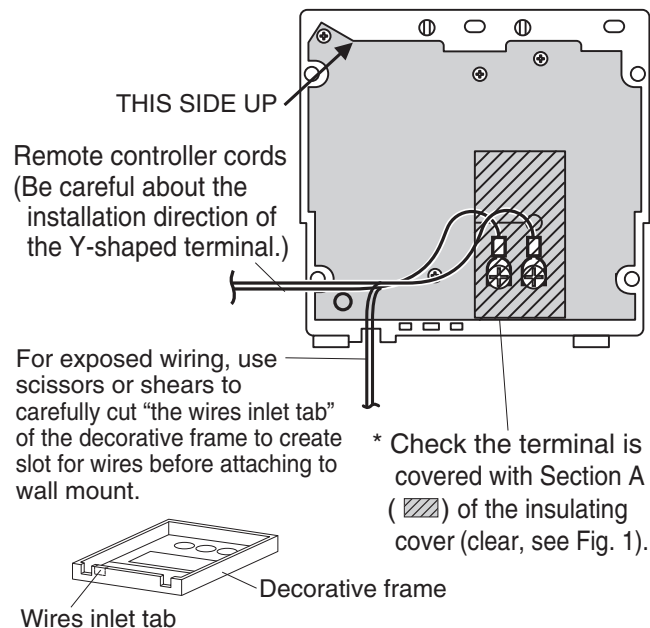

- \* If the Y-shaped terminal is not covered, the exposed section may come into contact with the mounting bracket resulting in improper operation or failure.

4. Secure the remote controller cords by winding them around the notches as shown in Fig. 1.

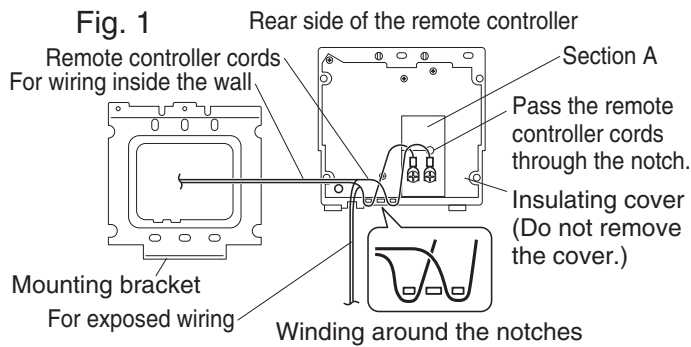

5. Attach the remote controller to the mounting bracket. Insert the bottom of the remote controller into the groove at the bottom of the bracket and push in the 2 hooks on top of the remote controller completely.

\* If it is difficult to attach, do not try to force it as it may result in broken hooks. Check for proper alignment in the groove or for loose wires obstructing the remote controller.

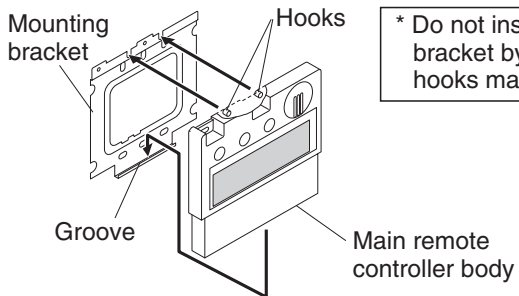

\* Do not install on the bracket by force, the hooks may break.

6. Secure the remote using the machine screws.

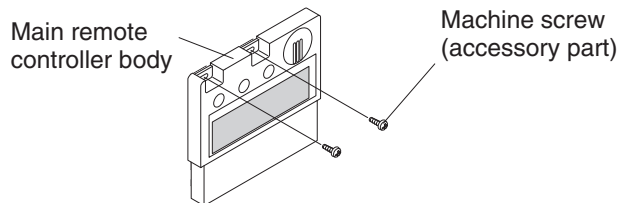

7. Attach the decorative frame which was removed in the second step.

Push the 4 corners of the decorative frame until there is a click.

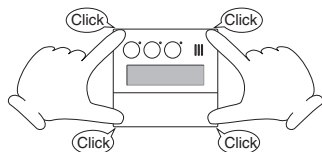

\* Incomplete installation may result in failures such as switch operation failure.

Note: To remove the decorative frame after installation of the remote controller and the frame, pull the entire decorative frame forward while pressing the sections indicated (where the fingers are) in the figure below.

\* If it does not come off, insert a flat head driver into the notch at the bottom of the decorative frame and slightly twist it to remove (due caution is required not to scratch the remote controller, decorative frame or the wall in doing so).

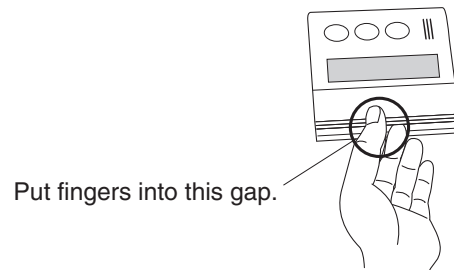

# 11. Condensate Piping only WHiCX56 series

## ⚠ CAUTION

Due to the acidic nature of the condensate, be sure to properly drain and if necessary, treat the condensate prior to disposal. Damage caused by improperly handled condensate is not covered by the warranty.

- This water heater is a high efficiency, fully condensing appliance which produces acidic condensate during operation. The water heater incorporates a collection and removal system which must be properly drained in order to ensure proper operation of this appliance.
- The pH level of the condensate is approximately 2-3. It should be drained as required by local code or when the condensate could cause damage.
- In order to drain the condensate, a 1/2" threaded fitting is provided at the base of the water heater. Do not reduce the size of this fitting or the drain piping to less than 1/2". In cold climates, do not drain the condensate to the outdoors. If the drain pipe freezes during cold weather, the pipe will not drain condensate and the unit will stop operating.
- Use plastic pipe, such as PVC, for the drain line. Do not use steel, black iron, or any other material which can corrode when placed into contact with acidic condensate.
- Keep the length of the drain pipe as short as possible. Long runs or applications where the nearest drain is above the water heater will require the use of a condensate pump. Size the pump to allow for a maximum condensate discharge of 100ml/minutes from the water heater.
- Horizontal runs must be sloped 1/50 downwards the drain or condensate pump. The condensate will be discharged by gravity force only. Make the drain pipe run as short as possible.
- The end of the drain pipe must not be submerged in water or blocked in any way. To ensure proper drainage, leave the end of the drain pipe open to the atmosphere. Do not have a trap. Also, make sure that there are no obstructions blocking the drain line from discharging condensate.
- Be sure to check that condensate is freely flowing from the drain piping after the system has been installed. Condensate will begin flowing out of the water heater within 15 minutes after operation has started.
- Take measures to prevent the condensate drain lines from freezing (insulation, heat tape, electric heaters, etc.).

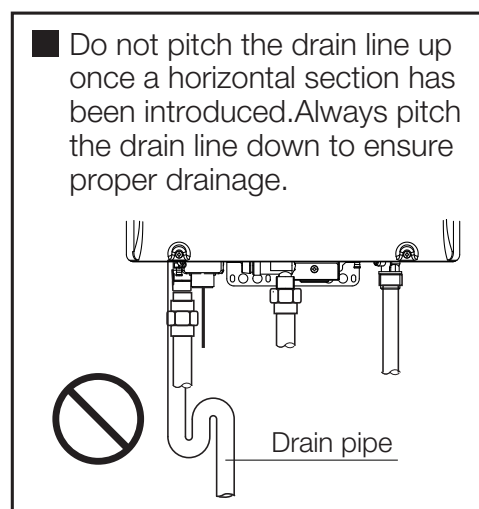
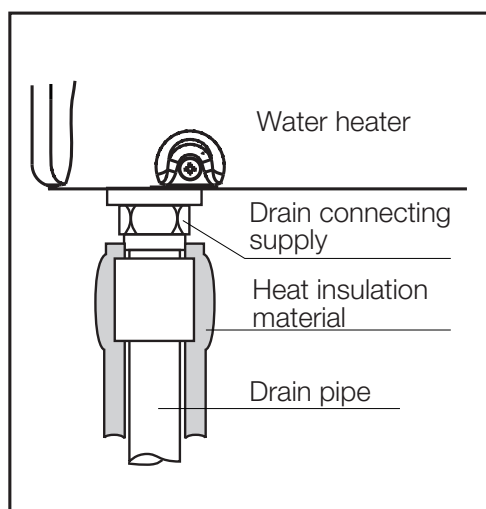

Condensate piping to floor drain

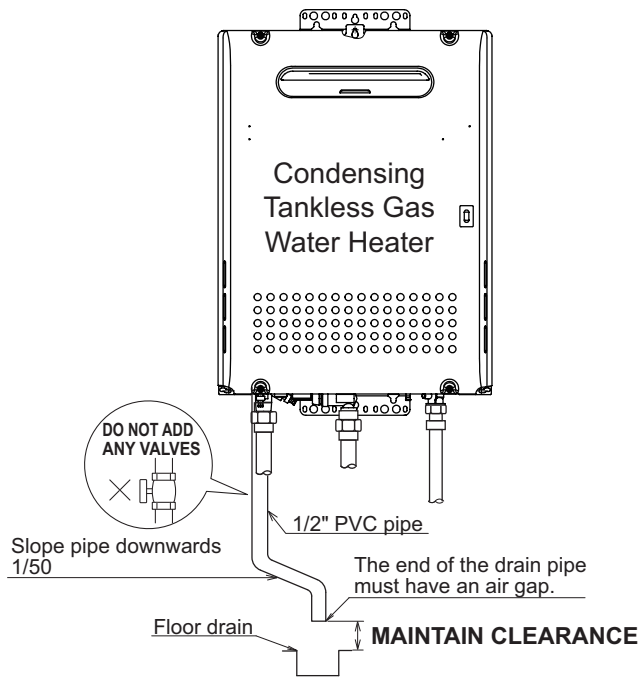

Condensate piping with pump

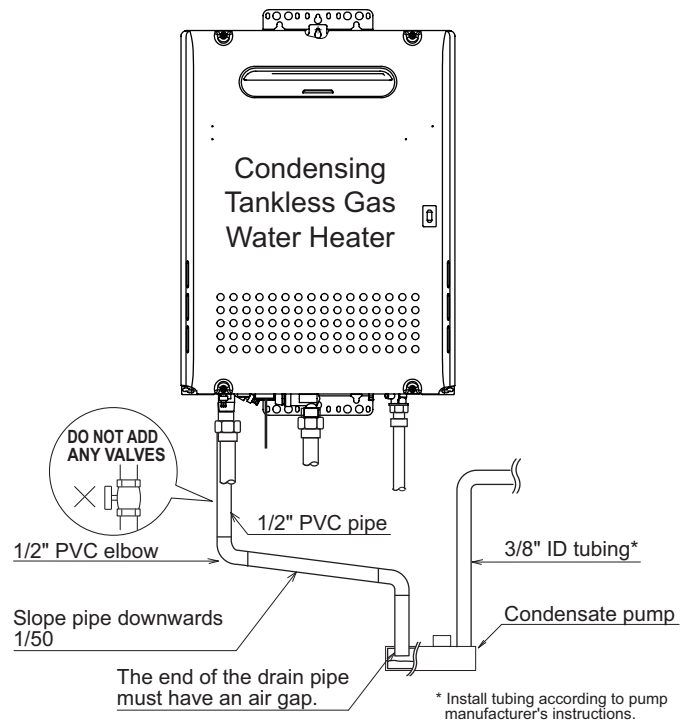

Note:

If the drain line becomes clogged or frozen, condensate will back-up into the water heater and a "29" error code will flash on the remote controller, ceasing operation. If this occurs, clear the clog or freeze so that condensate can freely flow. Be sure to slope the drain pipe, use the appropriate size pipe, allow the proper clearances, and apply freeze prevention measures (when necessary) to prevent the drain line from clogging or freezing.

# 12. Trial Operation

The installer should test operate the unit, explain to the customer how to use the unit, and give the owner this manual before leaving the installation.

- Preparation ..... (1) Open a hot water fixture to confirm that water is available, and then close the fixture.  
(2) Open the gas supply valve.  
(3) Turn on the power supply. Using the remote controller, turn on the Power ON/OFF button (the Operation lamp will turn on).

- (1) Open a hot water fixture and confirm that the Burner on lamp comes on, and that hot water is being produced. (If necessary, repeat until the air in the gas piping is bled out).
  - \* White smoke may be noticed from the exhaust vent during cold weather. However, this is not a malfunction of the unit.
  - \* If an "11" error code appears on the remote controller, turn the unit off and then back on again, and then open a hot water fixture again.

- (2) Change the temperature setting on the remote controller and check that the water temperature changes.

- If the water heater does not operate normally, refer to "Troubleshooting" in the Owner's Guide.
  - \* After the trial operation, clean the filter in the cold water inlet.

<If installed with a quick connect multi-system>

- Turn the system power ON with the remote controller.
- Slowly open a hot water fixture and check that the units ignite sequentially. Check to see that the hot water temperature is the same as the temperature displayed on the remote controller (\*1)

- \* If both units do not ignite, switch which unit will ignite first by pressing the Max. or Min. Manifold Pressure Set Button on the circuit board. (\*2)

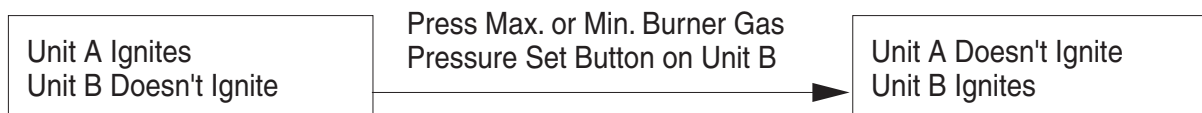

- \* If an 11 or F11 error code flashes on the remote controller, hit the Power Button on the remote controller off and on 2-3 times.

- \* If (\*1) and (\*2) cannot be done, the Quick Connect Cord-2 may not be properly connected. Check that the cord is properly connected.

## CAUTION

### Handling after trial operation

- If the unit will not be used immediately, close off all gas and water shut off valves, drain all of the water out of the unit and the plumbing system to prevent the unit and system from freezing, and bleed the gas out of the gas line.  
Freezing is not covered by the warranty.



## WARNING

A fire or explosion may result if these instructions are not followed, which may cause loss of life, personal injury or property damage.

### Lighting Instructions

This water heater does not have a pilot. It is equipped with an ignition device that automatically lights the burner.

Do not try to light the burner by hand.

1. Read the safety information in the installation manual or on the right side of the water heater.
2. Turn off all electrical power to the unit.
3. Do not attempt to light the burner by hand.
4. Turn the gas control manual valve (external to the unit) clockwise to the off position.
5. Wait five minutes to clear out any gas. If the smell of gas remains, stop, and follow the instructions on page 3 of Owner's Guide.
6. Turn the gas control manual valve counterclockwise to the on position.
7. Turn on electric power to the unit.
8. The unit will now operate whenever hot water is called for. If the unit will not operate, follow the shutdown instructions and call a service technician.

### Shutdown Instructions

1. Stop any water demand.
2. Turn off electric power.
3. Turn the gas control manual valve clockwise to the off position.

Should overheating occur, or the gas supply fail to shut off, turn off the manual control valve to the appliance.



# 13. Dimensions

## WHiCX56 Series

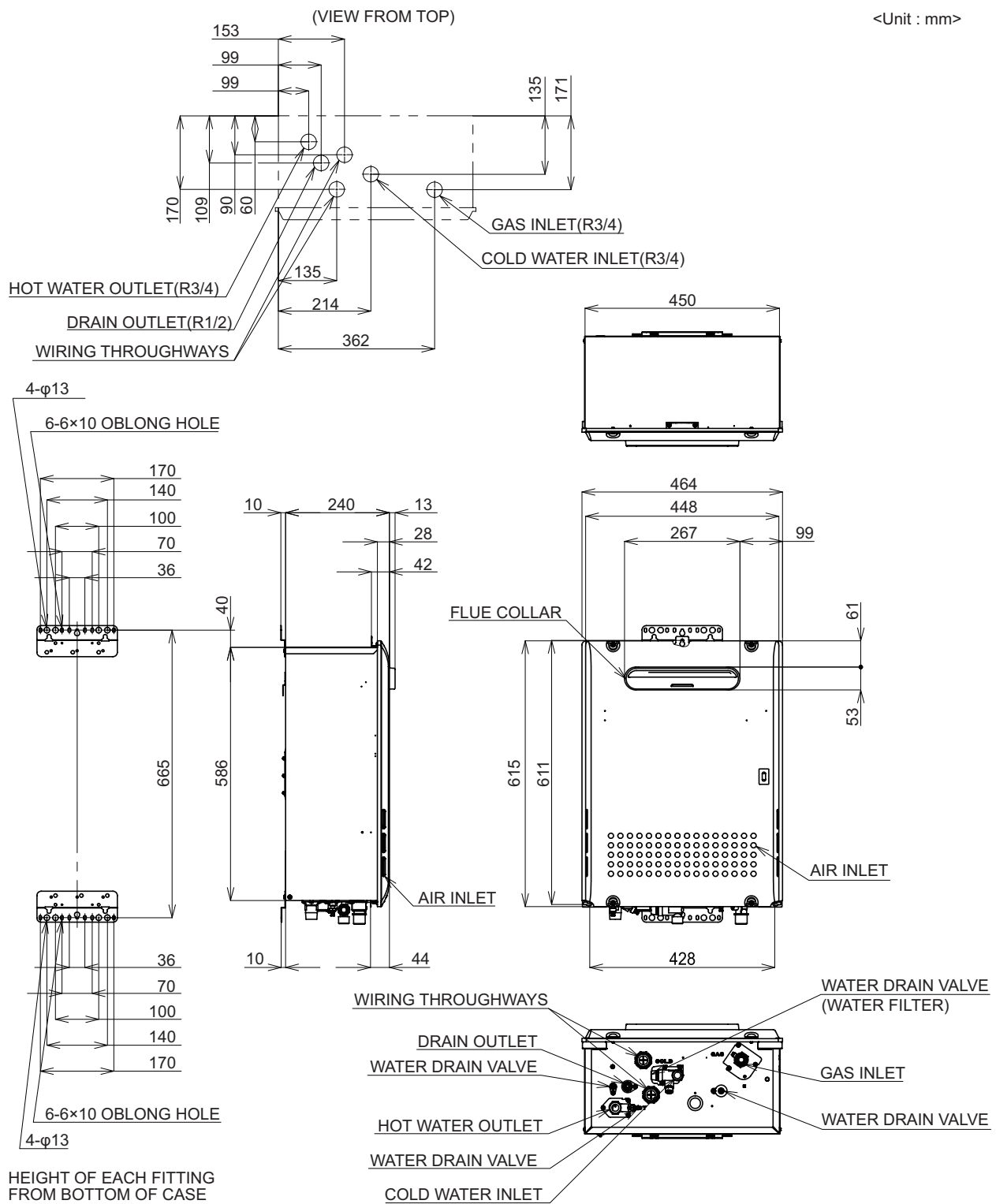

# WHiX49 series

(VIEW FROM TOP)

<Unit : mm>

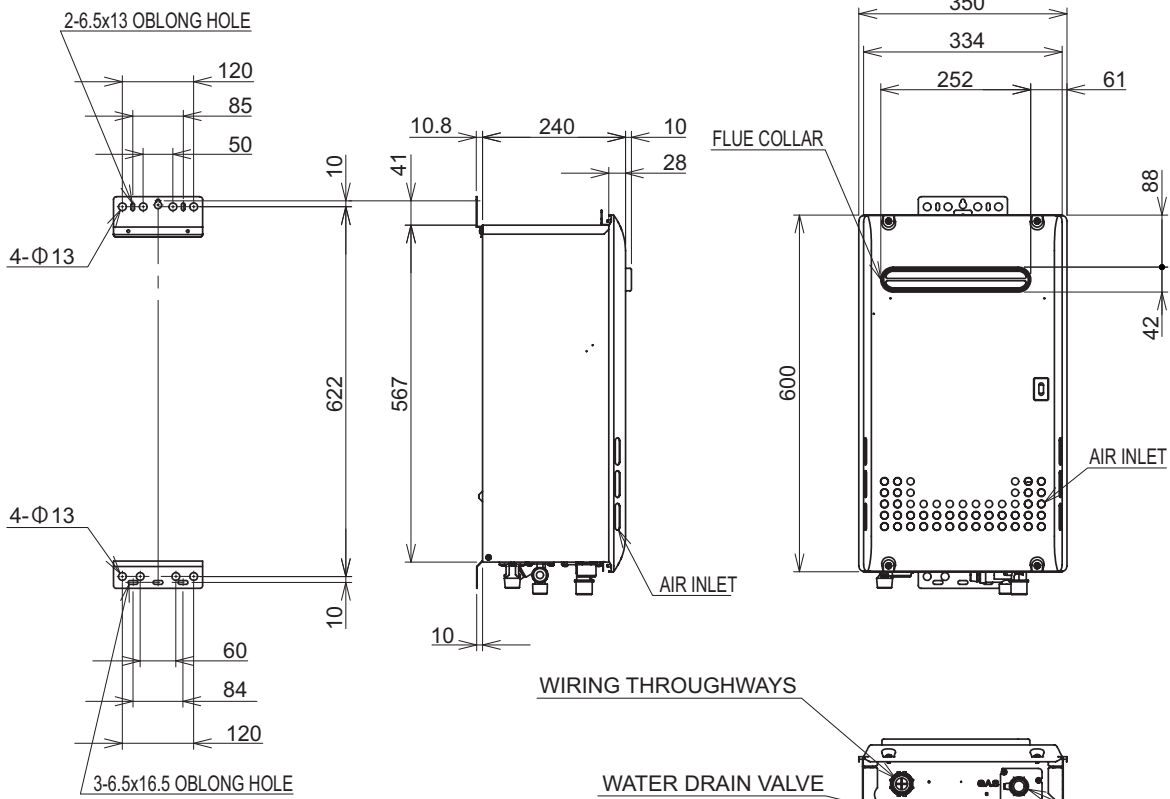
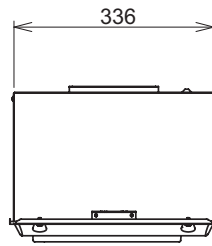
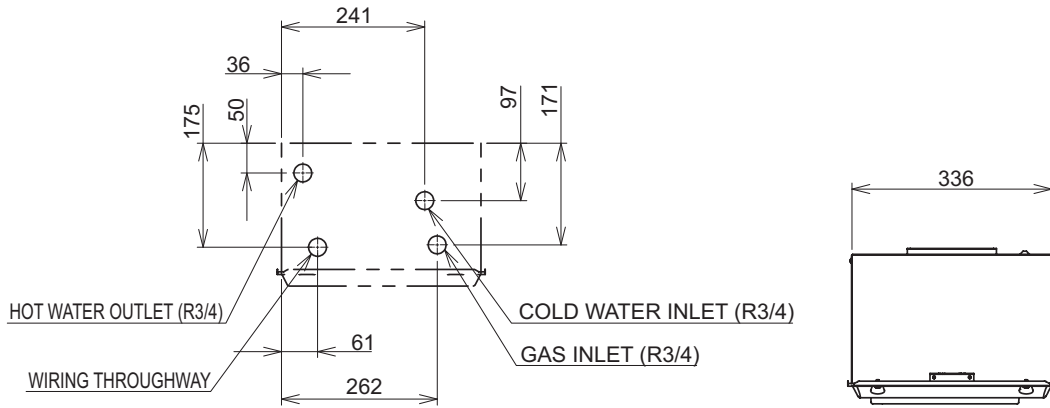

HEIGHT OF EACH FITTING FROM BOTTOM OF CASE

HOT WATER OUTLET	45
COLD WATER INLET	55
GAS INLET	56

# Wiring Diagram

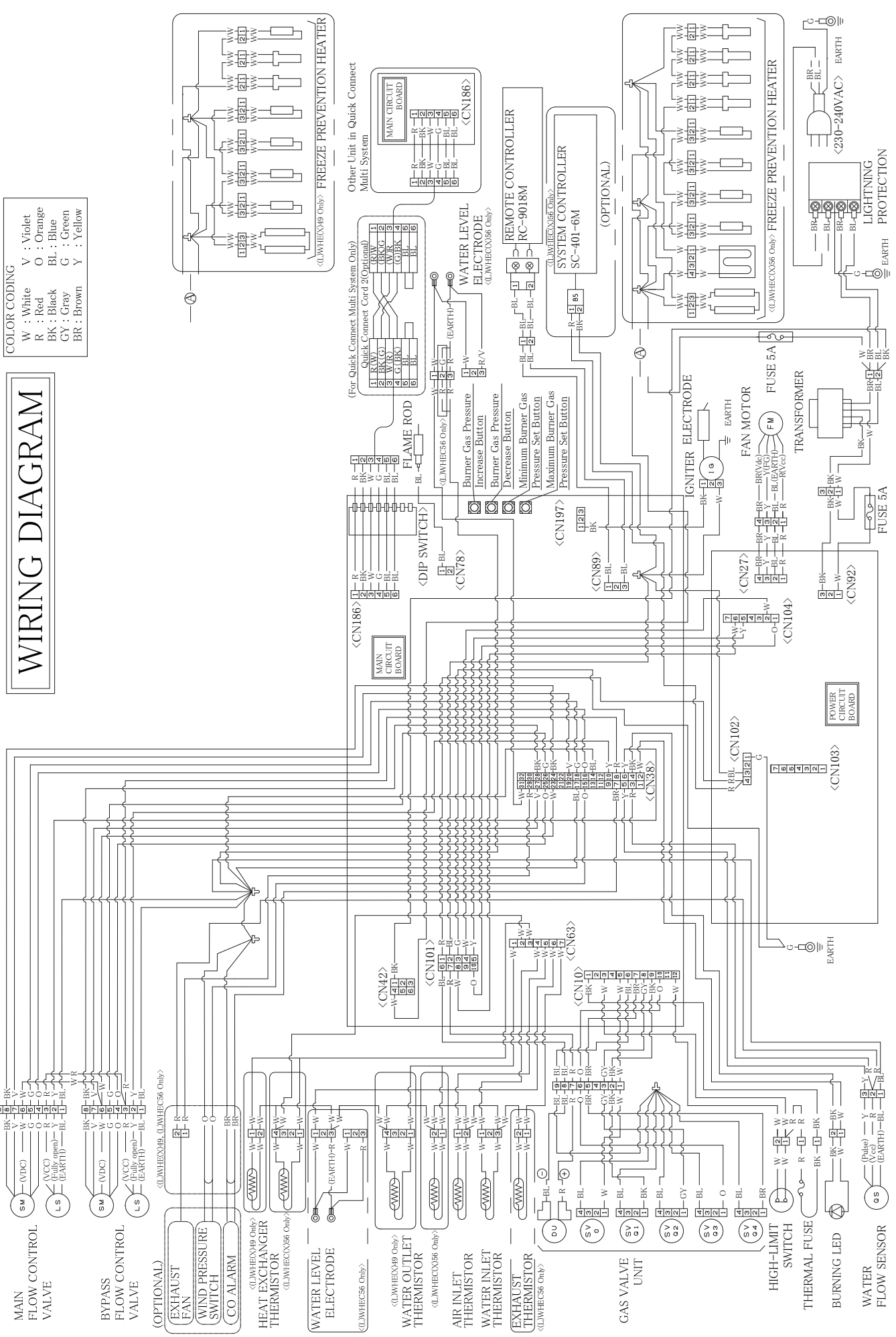

**COLOR CODING**  
 W : White  
 R : Red  
 BK : Black  
 GY : Gray  
 BR : Brown  
 V : Violet  
 O : Orange  
 BL : Blue  
 G : Green  
 Y : Yellow

## WIRING DIAGRAM

# Wiring Diagram

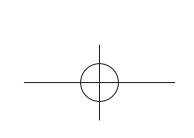
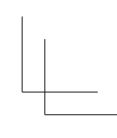
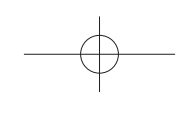
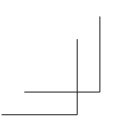
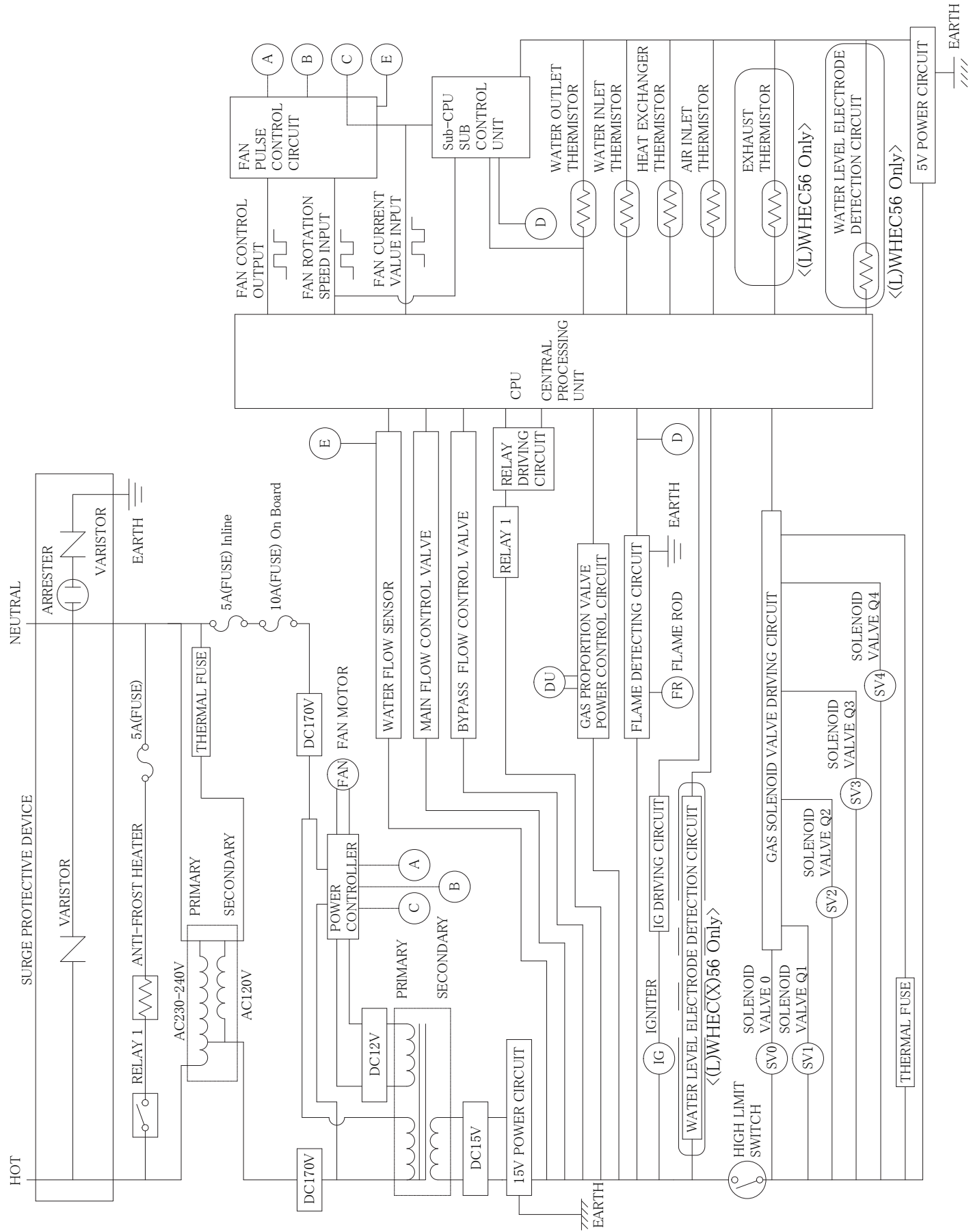



# 14. Maintenance

Periodically check the following to ensure proper operation of the water heater.

- The venting system must be examined periodically by a qualified service technician to check for any leaks or corrosion.
- The burner flame must be checked periodically for a proper blue colour and consistency.
- If the flame does not appear normal, the burner may need to be cleaned.
- If the burner needs to be cleaned, it must be performed by a qualified service technician.
- Do not obstruct the flow of combustion and ventilation air.
- See Owner's Guide for further maintenance or consult Andrews Water Heaters for recommended service checks.

**Warning:** There is a scald potential if the output temperature is set too high.

Should overheating occur, or the gas supply fail to shut off, turn off the manual gas control valve to the appliance.

Do not use this appliance if any part has been under water. Immediately call a qualified service technician to inspect the appliance and to replace any part of the control system and any gas control which has been under water.

Periodically check and clean the filter inside the cold water inlet of the unit.

# 15. Specifications

- Specifications may be changed without prior notice.
- The capacity may differ slightly, depending on the water pressure, water supply, piping conditions, and water temperature.

## Specifications

Item		Specification
Model Name		WHiX49   LWHiX49
Type	Installation Air Supply/Exhaust	External, Wall Hanging Power Vented
Ignition		Direct Ignition
Minimum Pressure for Maximum flow		2.0 bar
Minimum Flow Rate		2.0 L/min.
Dimensions		60 cm(Height) x 35 cm(Width) x 24 cm(Depth)
Weight		26 kg
Water Holding Capacity		1.0 Litre
Connection Sizes	Water Inlet	R 3/4"
	Hot Water Outlet	R 3/4"
	Gas Inlet	R 3/4"
Power Supply	Supply	220 - 240 VAC (50Hz)
	Consumption	75.9W   75.9W Freeze Prevention 193W
Materials	Casing	Zincified Steel Plate/Polyester Coating
	Flue Collar	Stainless Steel
	Heat Exchanger	Copper Sheetting, Copper Tubing
Safety Devices		Flame Rod, Thermal Fuse, Pressure Relief Valve, Lightning Protection Device (ZNR), Overheat Prevention Device, Freezing Prevention Device, Fan Rotation Detector
Accessories		Anchoring Screws

## Performance

Item		Maximum Performance	Minimum Performance
Gas Consumption (NET)	G20	53.5 kW	4.35 kW
	G31	53.5 kW	4.35 kW
Hot Water Capacity	25°C Rise	28 L/min.	
	58°C Rise	12 L/min.	
Capacity Range		2.0 - 37 L/min.	
Temperature Settings		37 - 48, 50, 55, 60, 65, 70, 75, 80, 85°C	

## Specifications

Item		Specification
Model Name		WHiCX56      LWHiCX56
Type	Installation Air Supply/Exhaust	External, Wall Hanging Power Vented
Ignition		Direct Ignition
Minimum Pressure for Maximum flow		2.0 bar
Minimum Flow Rate		2.0 L/min.
Dimensions		61.5 cm(Height) x 46.4 cm(Width) x 24 cm(Depth)
Weight		32 kg
Water Holding Capacity		2.0 Litre
Connection Sizes	Water Inlet	R 3/4"
	Hot Water Outlet	R 3/4"
	Gas Inlet	R 3/4"
Power Supply	Supply	220 - 240 VAC (50Hz)
	Consumption	75.9W
		Freeze Prevention 223W
Materials	Casing	Zincified Steel Plate/Polyester Coating
	Flue Collar	Stainless Steel
	Heat Exchanger	Copper Sheeting, Copper Tubing
Safety Devices		Flame Rod, Thermal Fuse, Pressure Relief Valve, Lightning Protection Device (ZNR), Overheat Prevention Device, Freezing Prevention Device, Fan Rotation Detector
Accessories		Anchoring Screws

## Performance

Item		Maximum Performance	Minimum Performance
Gas Consumption (NET)	G20	53.5 kW	4.35 kW
	G31	54.5 kW	4.35 kW
Hot Water Capacity	25°C Rise	32 L/min.	
	58°C Rise	13 L/min.	
Capacity Range		2.0 - 42 L/min.	
Temperature Settings		37 - 48, 50, 55, 60, 65, 70, 75, 80, 85°C	

## ErP-Information

### Technical parameters

Product name			Fastflo WHi49	Fastflo WHiX49	Fastflo LWHi49	Fastflo LWHiX49	Fastflo WHiC56	Fastflo WHiCX56	Fastflo LWHiC56	Fastflo LWHiCX56
Daily electricity consumption	$Q_{elec}$	kWh	0.233	0.205	0.202	0.216	0.227	0.194	0.227	0.215
Declared load profile			XXL	XXL	XXL	XXL	XXL	XXL	XXL	XXL
Sound power level, indoors	$L_{WA}$	dB	61	66	61	66	58	62	58	62
Daily fuel consumption	$Q^{fuel}$	kWh	30.433	30.321	29.779	30.114	26.334	26.211	26.494	25.895
Emissions of nitrogen oxides	$NO_x$	mg/kWh	42.6	32.5	48.8	36.8	42.4	41.5	42.3	50.3
Weekly fuel consumption with smart controls	$Q_{fuel, week, sm}$	kWh	-	-	-	-	-	-	-	-
Weekly electricity consumption with smart controls	$Q_{elec, week, sm}$	kWh	-	-	-	-	-	-	-	-
Weekly fuel consumption without smart controls	$Q_{fuel, week}$	kWh	213	212	208	211	184	183	185	181
Weekly electricity consumption without smart controls	$Q_{elec, week}$	kWh	2	1	1	2	2	1	2	2



# 16. Multi System

Install one system controller (SC-401-6M) for every six units. Only WHiCX56 series.

## A. Installation without a recirculation system (Standard System)

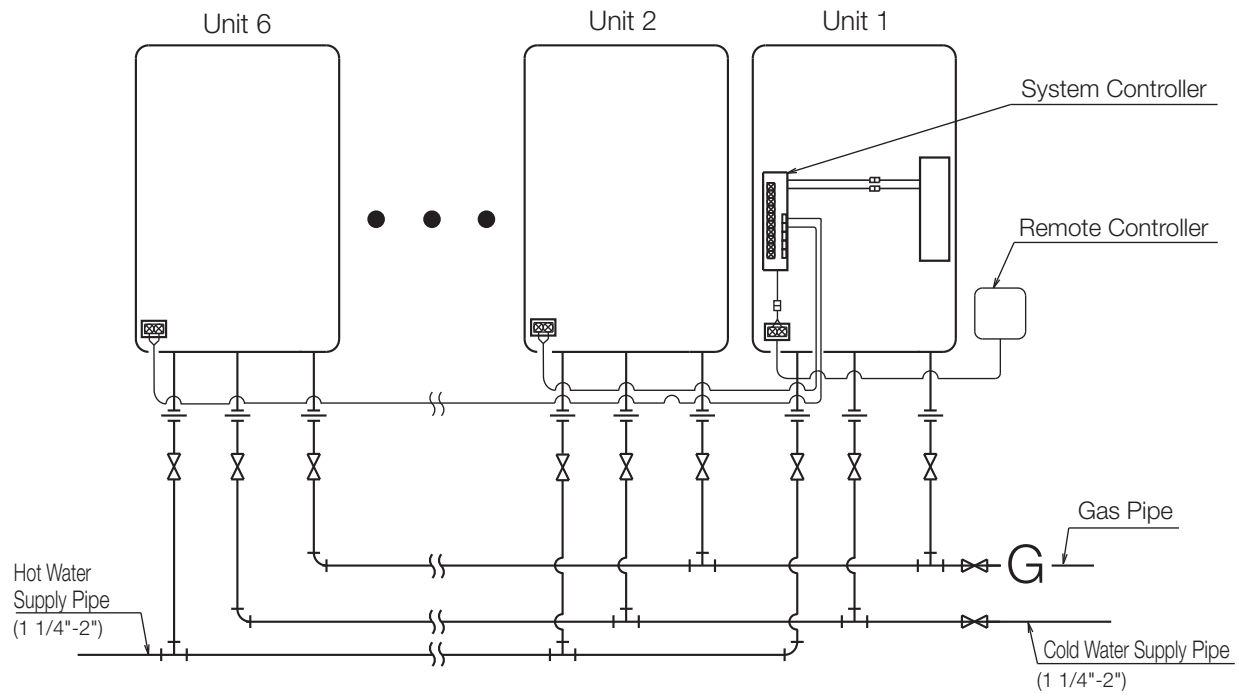

- Insulate or apply heating materials to both the cold water supply piping and the hot water supply piping to prevent freezing during cold weather and to prevent heat loss through the piping.

### B-1. Example of Recirculation with a Multi-System (Recirculation system)

This system will make hot water more quickly available to remote fixtures. The pump will circulate water through the loop until the entire loop is warm, and then the system controller will turn off the pump until the loop cools down.

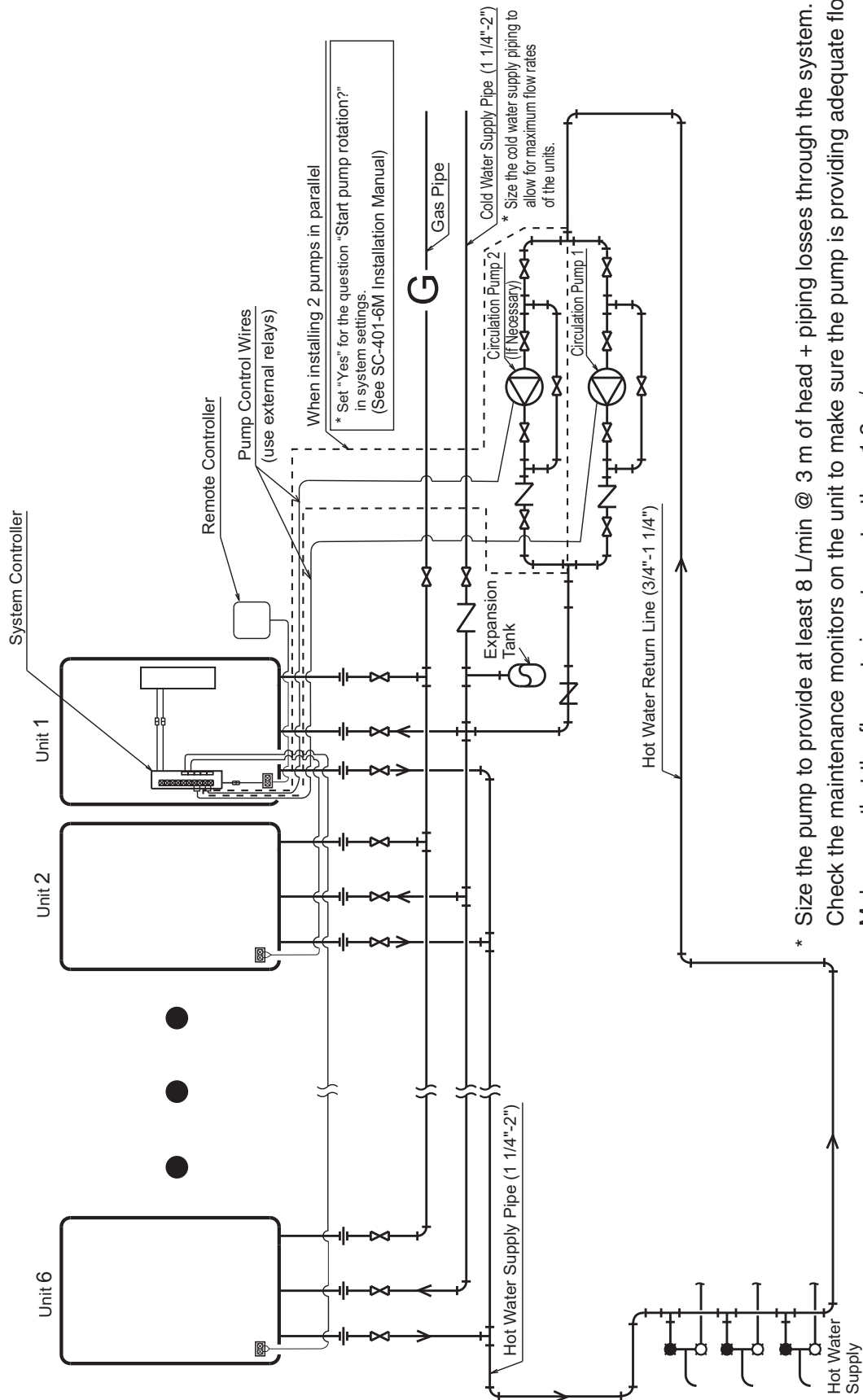

- \* Size the pump to provide at least 8 L/min @ 3 m of head + piping losses through the system. Check the maintenance monitors on the unit to make sure the pump is providing adequate flow.
- \* Make sure that the flow rate is not greater than 1.2 m/sec. (3/4": 20 L/min, 1 1/4": 50 L/min)
- If the flow is too low, the recirculation loop temperature will not be warm enough, if the flow is too high, the lifetime of the unit will be reduced.
- \* If there are multiple circulation loops, try to make the flow rate .3-5 L/min in each loop.
- \* Use copper or stainless water piping for the entire system.

## B-2. Example of Installation with a Storage Tank and Recirculation System (Tank recirculation system)

The pump will push water through the Multi-System to heat up the tank.  
When the temperature of the thermostat is high, the system controller will turn off the pump until the temperature cools down.

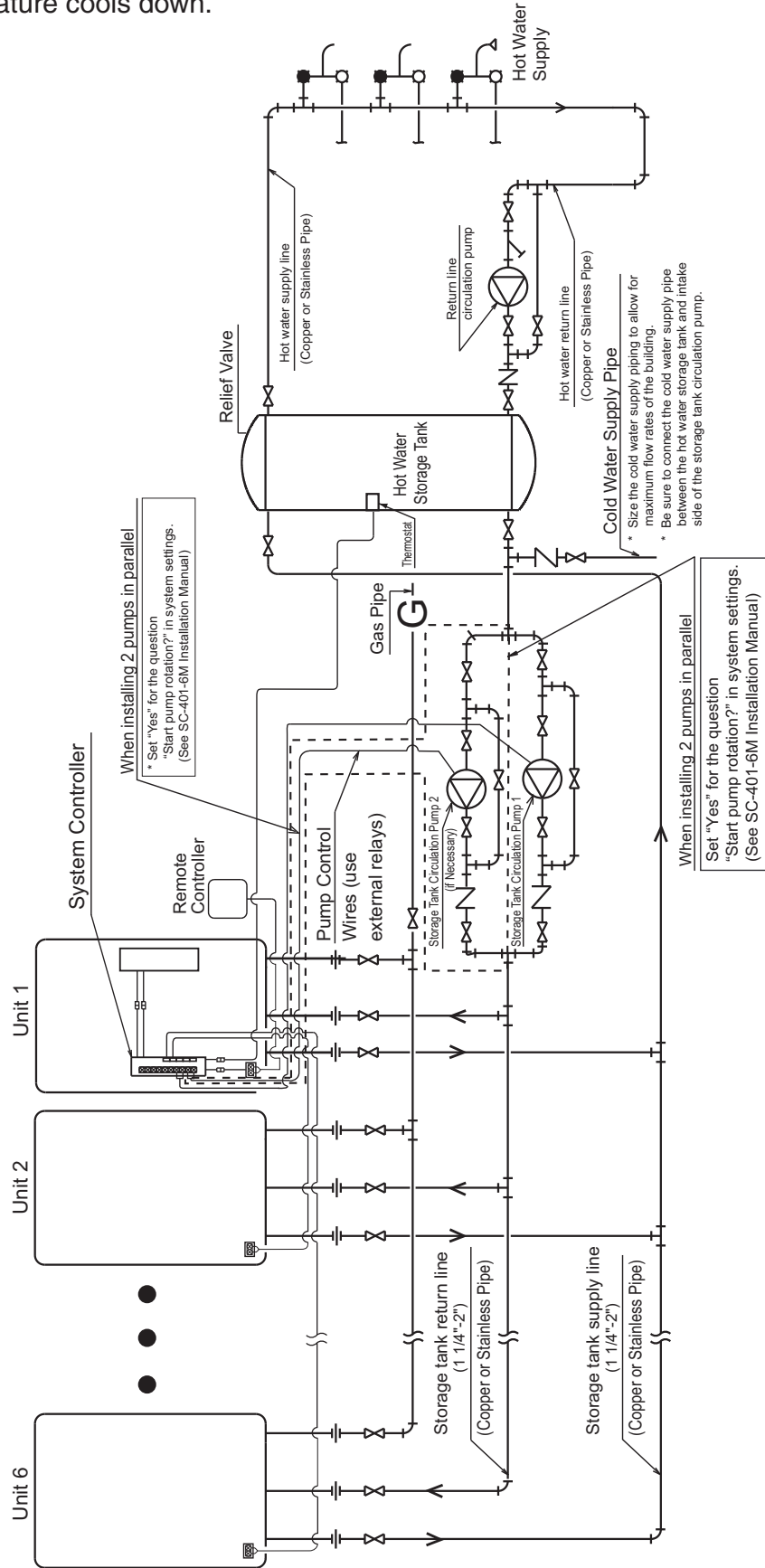

- \* For the set temperature of the remote controller, use the temperature (of the thermostat) + about 5 °C.
- \* To achieve the highest recovery, size the storage tank circulation pump for maximum capacity. (34 L/min (each) @ 10 m of head (70°C setting or less) + piping losses through the system.)  
Verify the supply pressure to the units is at least 200 Kpa.

**Multi-System Wiring (Use SC-401-6M) Only WHiCX56 series**

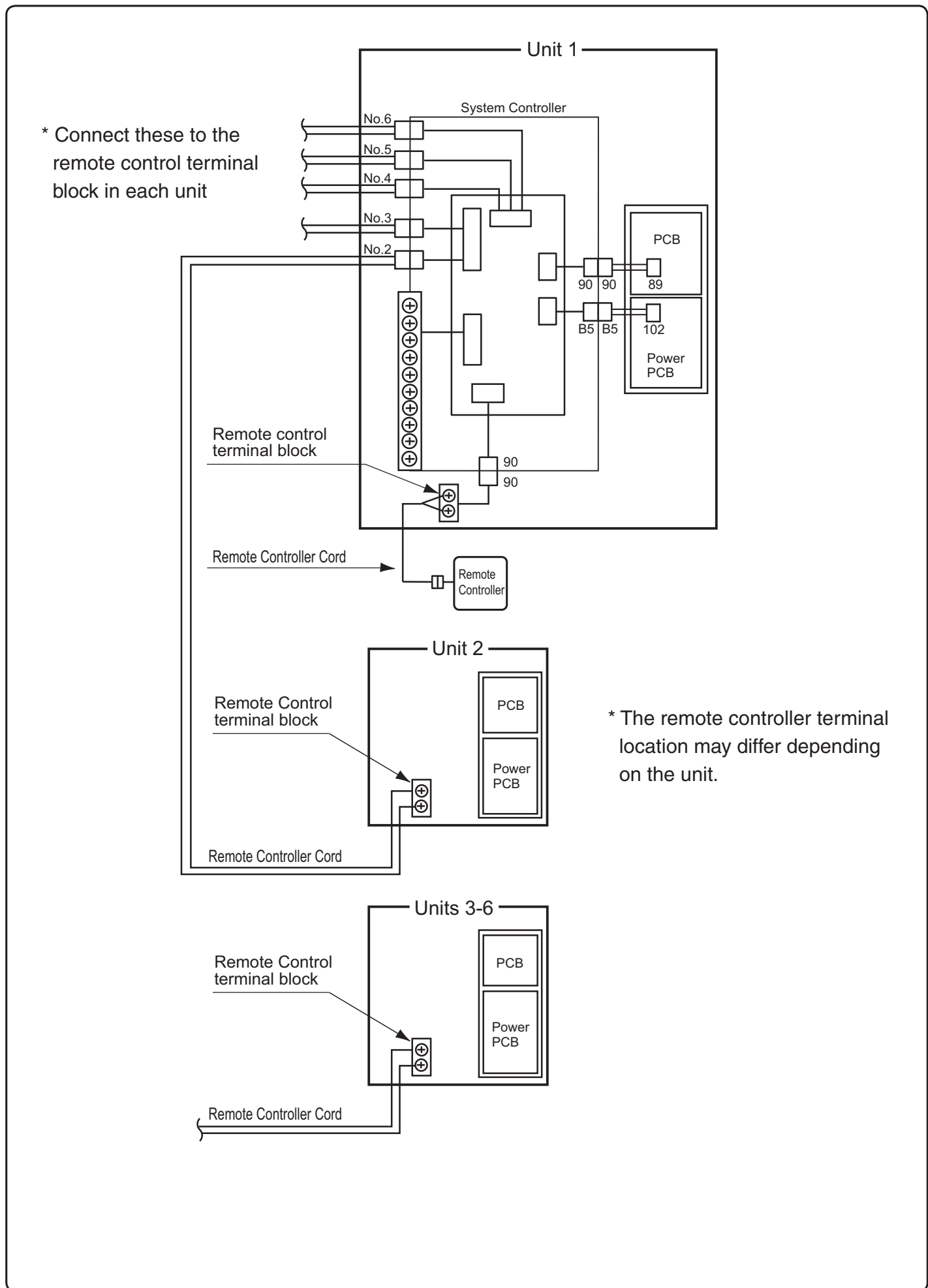

A. Installation without a recirculation system (Using external system controller)  
(Standard System)

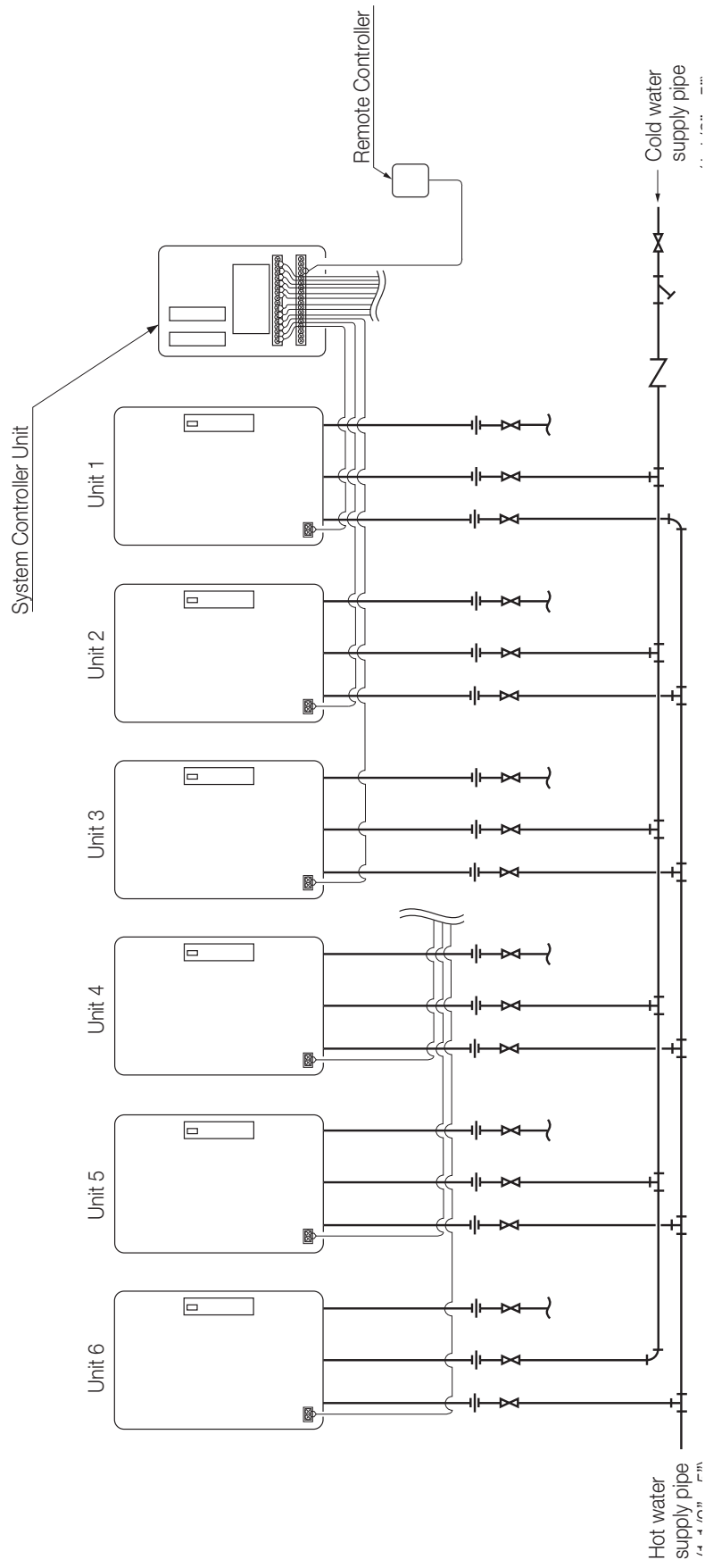

- Insulate or apply heating materials to both the cold water supply piping and the hot water supply piping to prevent freezing during cold weather and to prevent heat loss through the piping.

## B-1. Example of Recirculation with a Multi-System (Using external system controller) (Recirculation system)

This system will make hot water more quickly available to remote fixtures.  
The pump will circulate water through the loop until the entire loop is warm, and then the system controller will turn off the pump until the loop cools down.

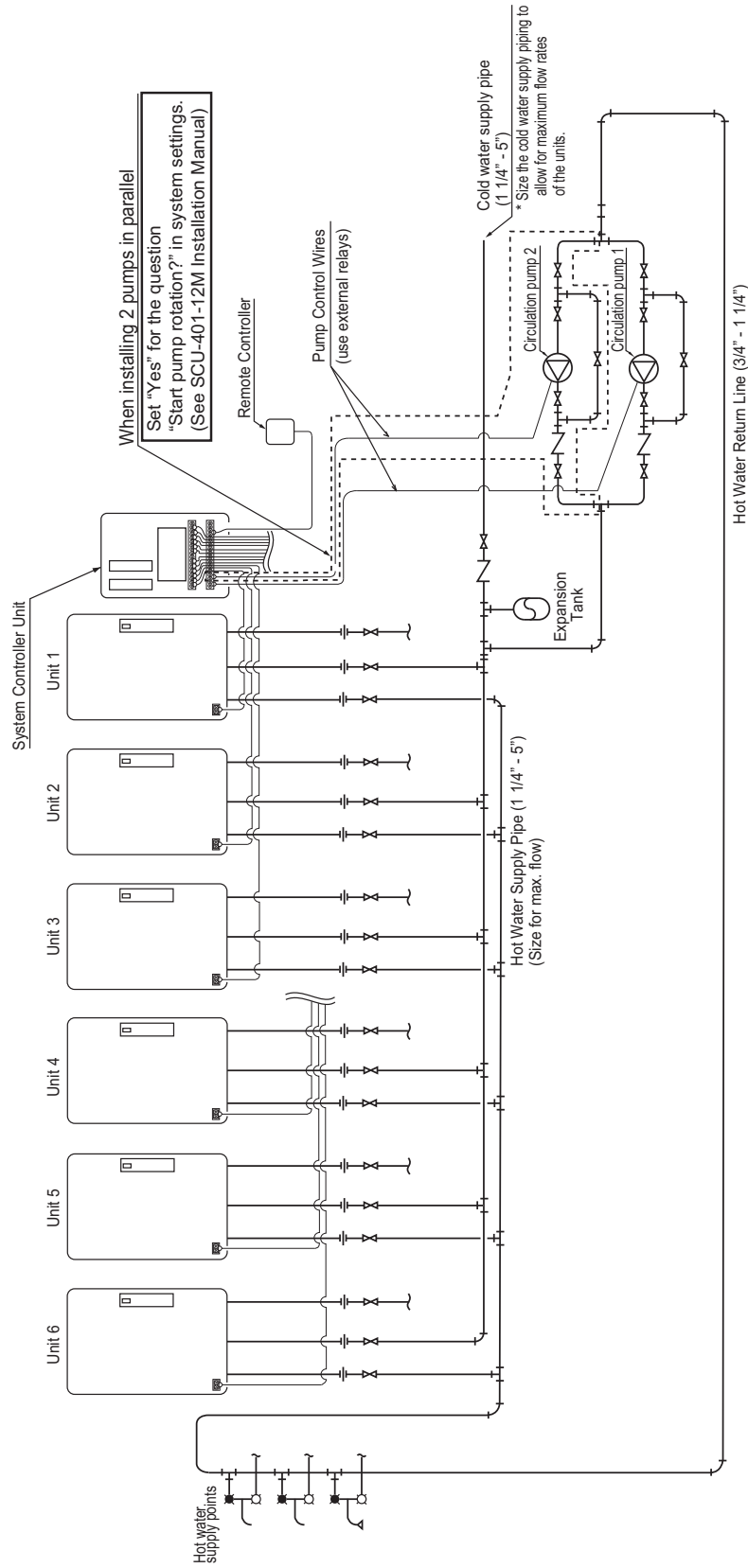

- \* Size the pump to provide at least 8 L/min @ 3 m of head + piping losses through the system.  
Check the maintenance monitors on the unit to make sure the pump is providing adequate flow.
- Make sure that the flow rate is not greater than 1.2 m/sec.  
(3/4": 20 L/min, 1 1/4": 50 L/min)
- If the flow is too low, the recirculation loop temperature will not be warm enough, if the flow is too high, the lifetime of the unit will be reduced.
- \* If there are multiple circulation loops, try to make the flow rate .3-5 L/min in each loop.
- \* Use copper or stainless water piping for the entire system.

**B-2. Example of Installation with a Storage Tank and Recirculation System (Using external system controller)  
(Tank recirculation system)**

The pump will push water through the Multi-System to heat up the tank.  
When the temperature of the thermostat is high, the system controller will turn off the pump until the temperature cools down.

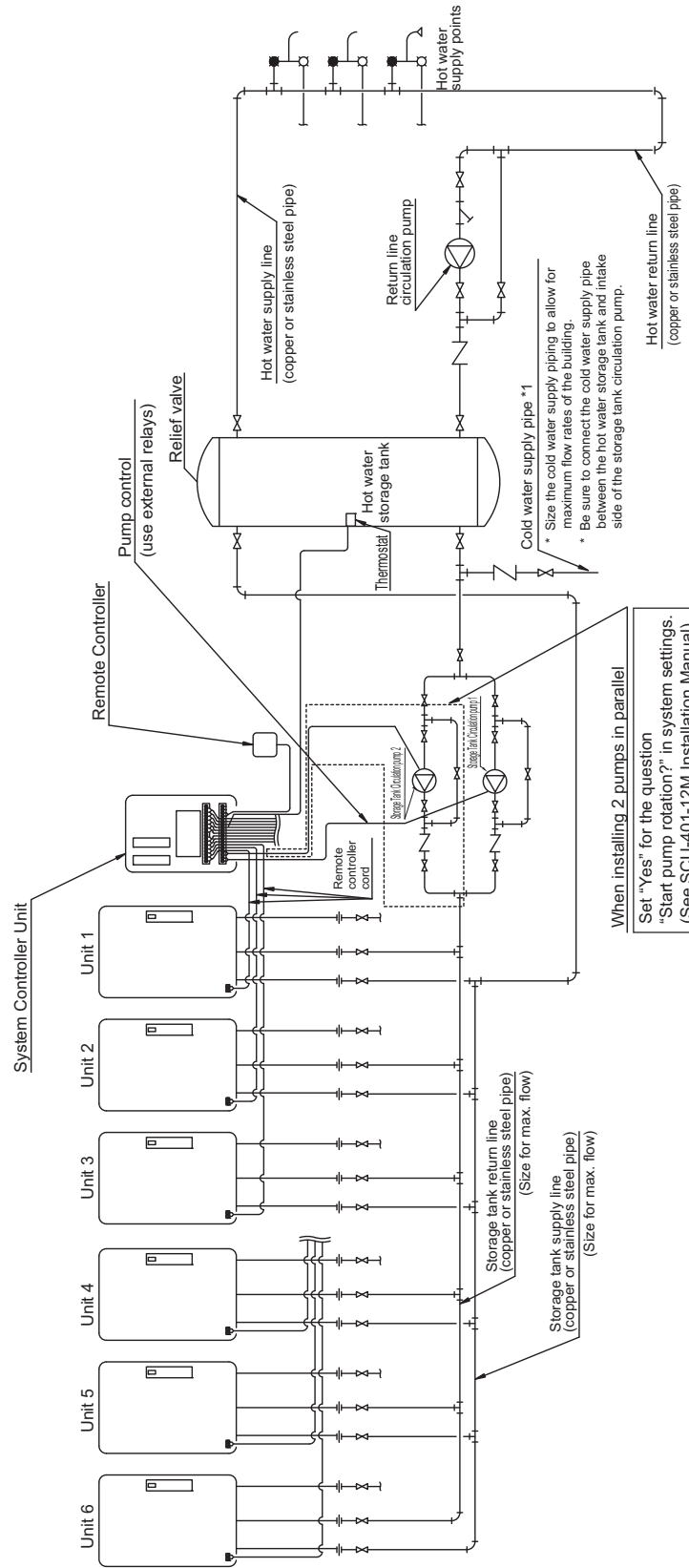

- \* For the set temperature of the remote controller, use the temperature (of the thermostat) + about 5 °C.
- \* To achieve the highest recovery, size the storage tank circulation pump for maximum capacity.  
(32ECR6 : 34 L/min (each) @ 12 m of head, 28ENR6 : 26 L/min (each) @ 10 m of head (75 °C setting or less) + piping losses through the system.)  
Verify the supply pressure to the units is at least 200 Kpa.

## Multi-System Wiring (Use SC-401-6M) Only WHiX49 series

### CAUTION

- The below diagram shows the connection of 3 units to the system controller. When connecting 4 or more units, follow the same procedure.
- Connect the water heaters to the system controller following the detailed wiring instructions included with the system controller.
- Always connect a remote controller to the system controller. Do not connect the included remote controllers to the individual water heaters. These remote controllers will not be used.

\* The remote controller terminal location may differ depending on the unit.

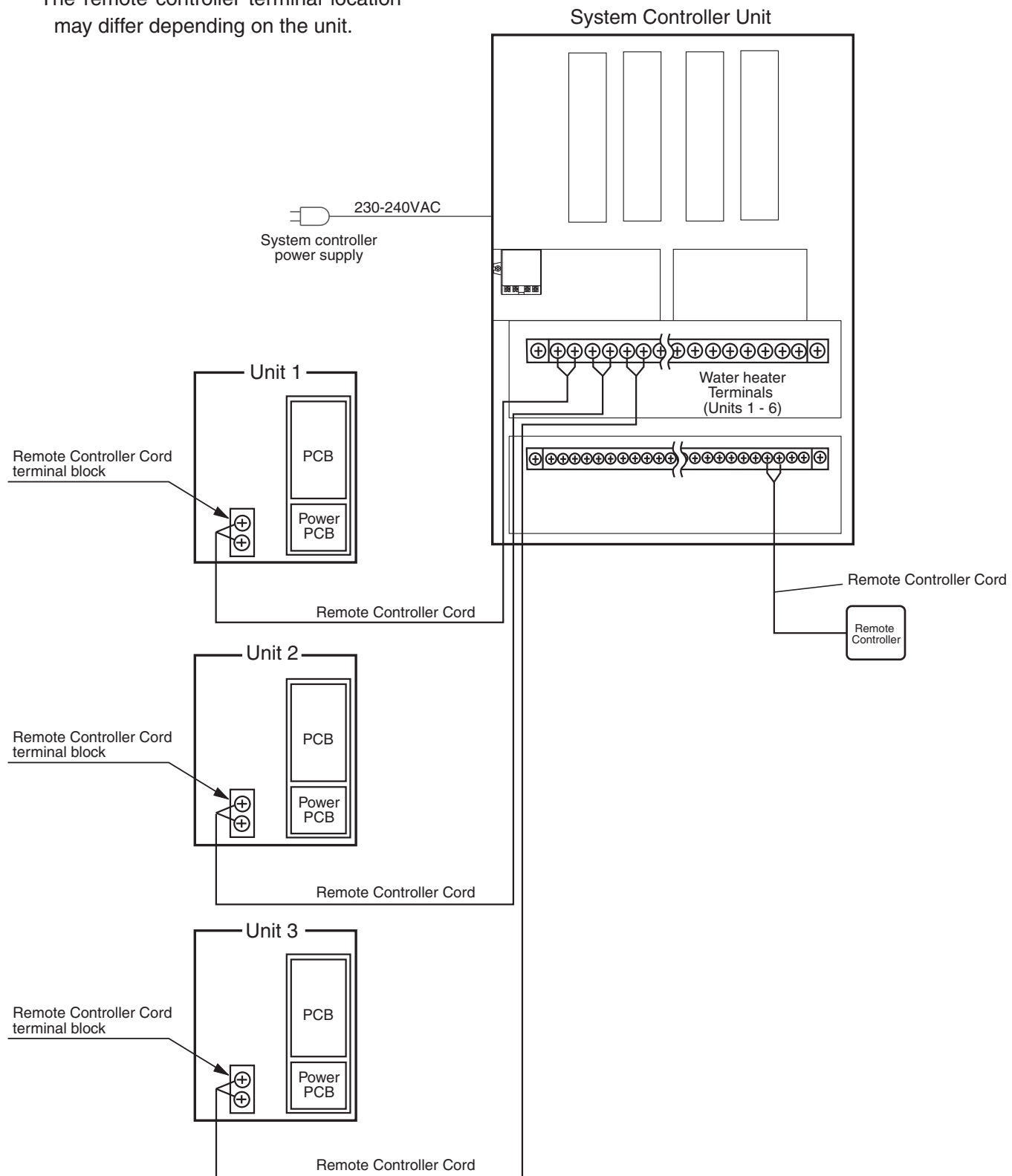



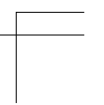
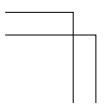
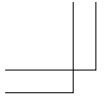

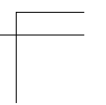
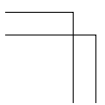
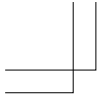

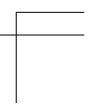
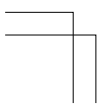
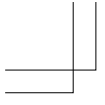



Register now to activate your warranty [www.andrewswaterheaters.co.uk/register-a-warranty](http://www.andrewswaterheaters.co.uk/register-a-warranty). Please make sure you attach proof of purchase for your warranty to be monitored.

*All descriptions and illustrations provided in this document have been carefully prepared but we reserve the right to make changes and improvements in our products which may affect the accuracy of the information contained in this leaflet. All goods are sold subject to our standard Conditions of Sale which are available on request.*

Aug 2017

Customer support

Monday - Friday

8am - 5pm

Tel 0345 070 1057

Fax 0345 070 1059

Email [service@baxicommercialdivision.co.uk](mailto:service@baxicommercialdivision.co.uk)

Website [www.andrewswaterheaters.co.uk](http://www.andrewswaterheaters.co.uk)

Twitter @AndrewsWH



Andrews. Built to perform.

part of **BAXI**  
COMMERCIAL