

ACO

End User
Manual

ACO 35 MFFI COMBI

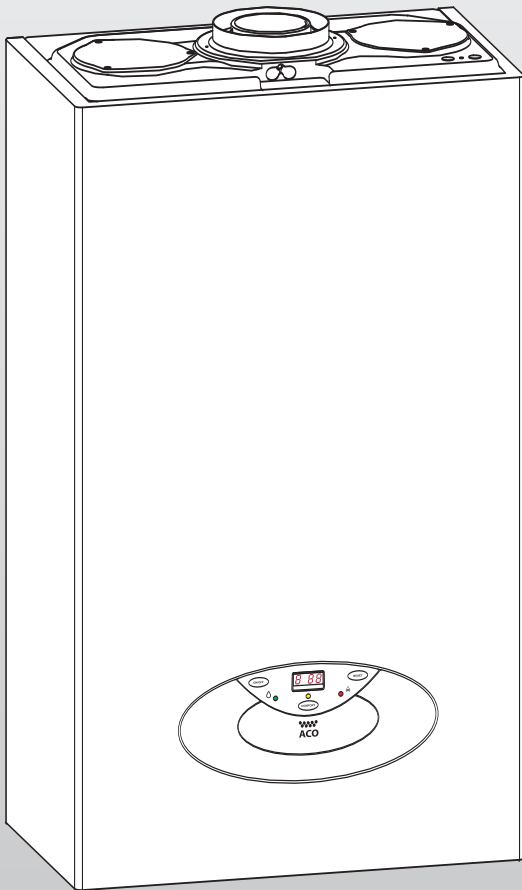

ARISTON



The code of practice for the installation,
commissioning & servicing of gas fires and wall heaters

Country of destination: GB/IE

Dear Customer,

Thank you for choosing an ARISTON boiler.
We guarantee that your boiler is a reliable and technically sound product.
This manual provides detailed instructions and recommendations for proper installation, use and maintenance.

Remember to keep this manual in a safe place for future reference i.e. by the gas meter.

Your local MTS Servicing Centre is at your complete disposal for all requirements.



GUARANTEE

The guarantee on this appliance is valid for 60 months from the first day of installation, subject to an annual service carried out by a qualified service engineer.

Repairs to the electric, water or gas circuits may only be carried out by your local authorised MTS Servicing Centre.

TABLE OF CONTENTS

1. GENERAL INFORMATION	page. 3
2. CONTROL PANEL	page. 4
3. OPERATING INSTRUCTIONS	page. 5
4. USEFUL INFORMATION	page. 8
5. MECHANICAL TIME CLOCK	page. 9
6. DIGITAL PROGRAMMER	page. 10

IMPORTANT!

Please read this manual carefully.

For additional information, please consult the "Installation and Servicing Instructions."

Make sure to keep the manuals provided with the appliance so that they can be used by the end-user, installer or our authorised engineer.

Every attempt has been made to avoid errors of any kind in this manual, the Management

invites customers to inform of any inaccuracies which they may find.

This will help to improve our service.

1. GENERAL INFORMATION

MTS (GB) Limited support the *benchmark* initiative. Your installer will give you, and show you how to use, a Log Book which will give you important information about your boiler, and heating system. Please have this Log Book to hand whenever you contact a service engineer or us.

All CORGI Registered Installers carry a CORGI ID card, and have a registration number. Both should be recorded in your boiler Log Book. You can check your installer is CORGI registered by calling CORGI direct on :- (01256) 372300.

The ACO MFFI range of boilers are combined appliances for the production of Central Heating (C.H.) and Domestic Hot Water (D.H.W.).

This appliance **must be used only** for the purpose for which it is designed.

The manufacturer declines all liability for damage caused by improper or negligent use.

Do not allow children or inexperienced persons to use the appliance without supervision.

If you smell gas in the room, **do not turn on** light switches, use the telephone or any other object which might cause sparks. Open doors and windows immediately to ventilate the room. Shut the gas mains tap (on the gas meter) or the valve of the gas cylinder and call your Gas Supplier immediately.

If you are going away for a long period of time, remember to shut the mains gas tap or the gas cylinder valve.

Before any intervention within the boiler it is first necessary to isolate the electrical power supply by turning the external switch to "OFF".

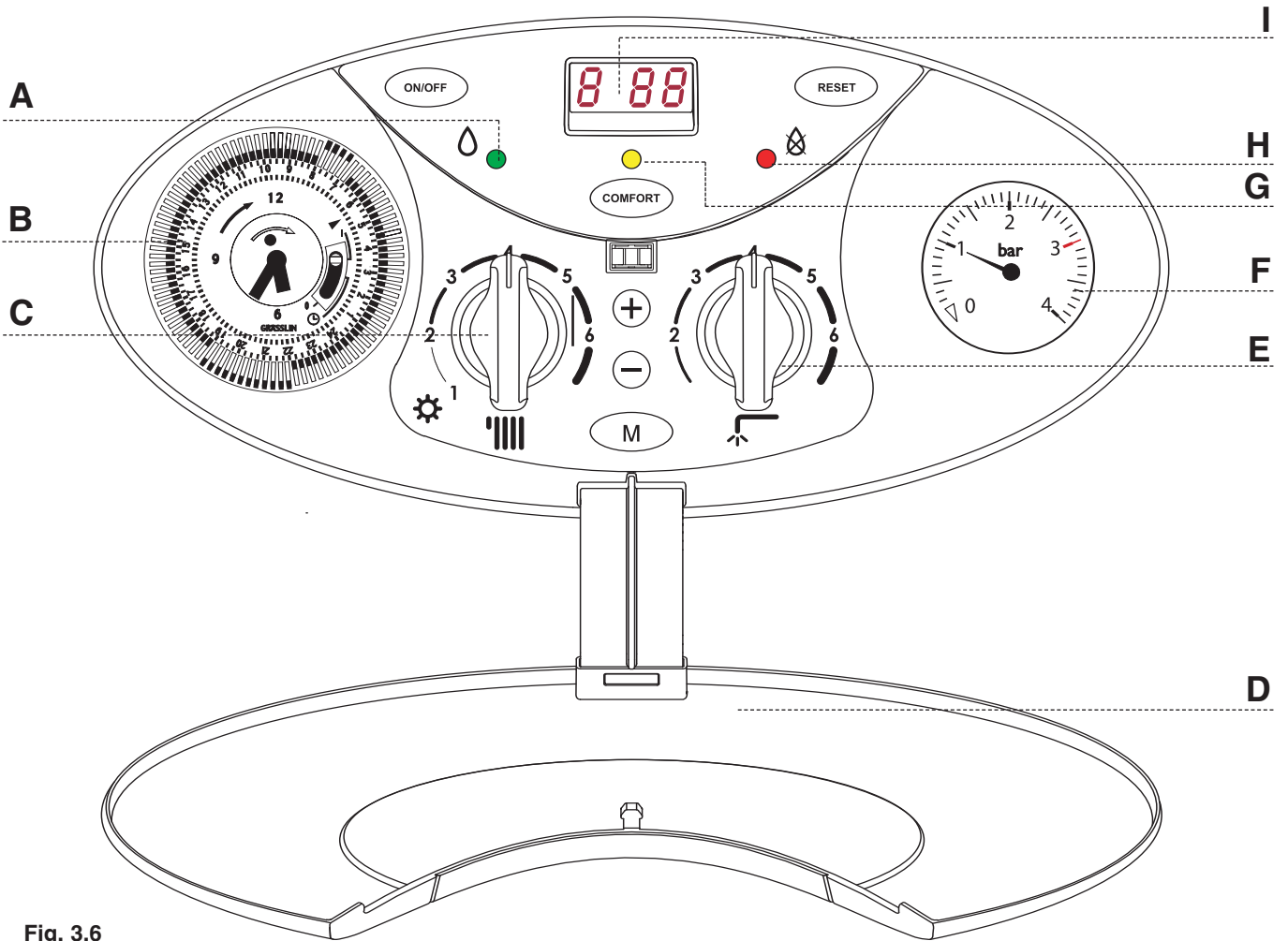
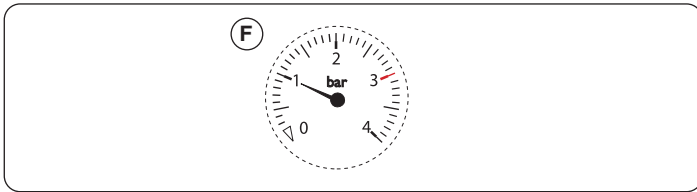
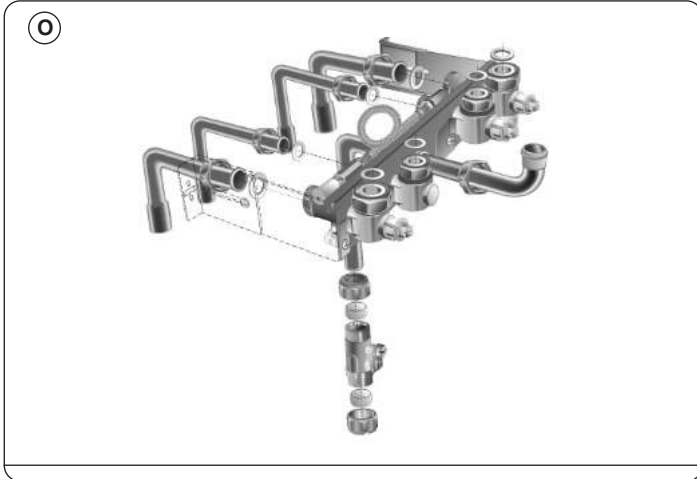

Fig. 3.6

Button	Description		Description
ON/OFF	ON/OFF Switch	A	Green LED (illuminated = burner on)
COMFORT	"COMFORT" Function Push-button	B	Time clock
RESET	Reset Button/ Flue Test**/ scroll through Functions Menu	C	Selector knob for Summer/Winter Central Heating Temperature Adjustment Knob
M	Menu Switch	D	Control Panel Cover
+	Programming "+" key	E	Domestic Hot Water Temperature Adjustment Knob
-	Programming "-" key	F	Heating System Pressure Gauge
		G	"COMFORT" Function L.E.D
		H	Red LED (illuminated = boiler lockout)
		I	Multi-function Display

**** IMPORTANT!!**
The Flue Test function will cause the boiler to run continuously on maximum power. This function must only be activated by an authorised engineer.

3. OPERATING INSTRUCTIONS



CAUTION!!

In the United Kingdom installation, start-up, adjustments and maintenance must be performed by a CORGI registered installer in accordance with the installation standards currently in effect, as well as with any and all local health and safety standards i.e. CORGI.

In the Republic of Ireland the installation, and initial start-up of the appliance must be carried out by a Competent Person in accordance with the current edition of I.S.813 " Domestic Gas Installations", and the current Building Regulations, reference should also be made to the current ETCI rules for electrical installation.

Improper installation may cause damage or injury to individuals, animals and personal property, for which the manufacturer will not be held liable.

To ensure efficient and safe operation it is recommended that the boiler is serviced annually by a competent person.

If it is known or suspected that a fault exists on the appliance, it must not be used until the fault has been corrected by a competent person.

Helpful Suggestions

To get the most out of your boiler, we have provided you with some useful advice on proper use and maintenance:

- Periodically check the system pressure using the pressure gauge "F" and make sure that the pressure is between 1.0 and 1.5 bar when the system is off and cool. If the pressure is below the minimum recommended value, the pressure must be brought into the acceptable range. To refill the system, connect the flexible hose to the cold water inlet and central heating flow, open the two black handles connected to the silver flexible hose, once the pressure gauge "F" reads 1.5 bar close the valves again and disconnect the flexible hose.

If the pressure level drops on a frequent basis, it is likely that there is a water leak in the system. If this is the case, your installer must inspect the system.

- The outer panels of the boiler's case must only be cleaned with a damp cloth, do not use abrasive cleaners. The control panel can be wiped with either a damp or dry cloth. Spray polishes must not be used on the control panel surface or knobs. Care must be taken in preventing any liquid entering the appliance.
- If the water is exceptionally hard, install a water softener so that the efficiency of the boiler remains the same over time, as this will consume less gas.
- To improve comfort levels and take full advantage of the heat produced by the boiler, it is necessary that an external thermostat and an outdoor sensor be installed.
- When the boiler is not in use for prolonged periods shut it down by pushing the **ON/OFF** button to the off position and close the gas and water isolation valves.

(Important!) This will disable the anti-frost device (see page 9) - if the period of disuse is very cold it will also be necessary to drain the heating system of water.

If you wish to leave the anti-frost device active, it is necessary to leave the boiler on: this will not safeguard from possible interventions which may impair this function.

- It is good practice to clean and service the appliance and Central Heating System every year.

Call a **CORGI** registered gas installer.

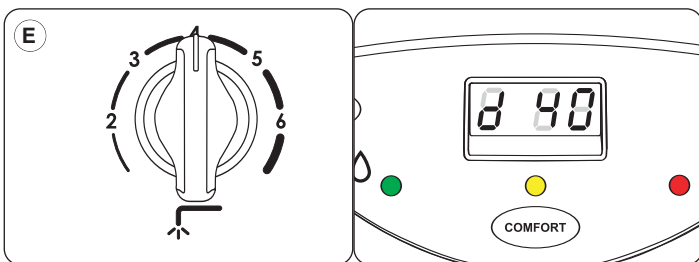
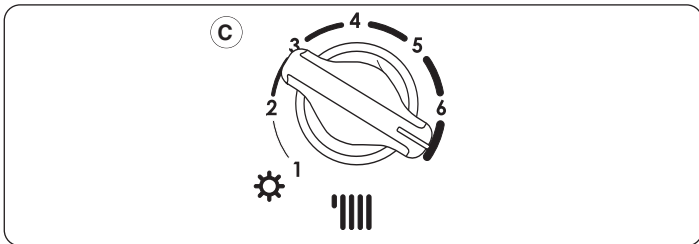
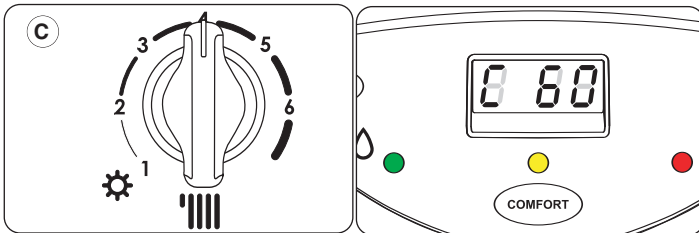
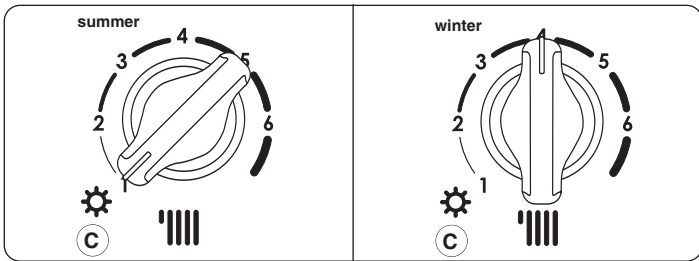
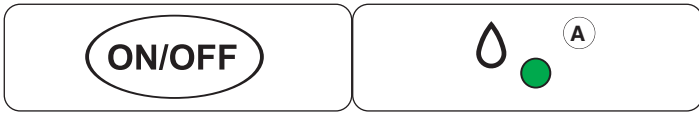
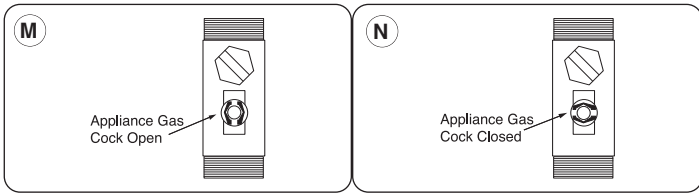

Start-up Procedure

Before starting the boiler, check the following:

- The water pressure on the pressure gauge "F" is between 1 and 1.5 bar;
- That the external gas cock "M" and "N" and the inlet for domestic water are open.

These models are equipped with electronic ignition (there is no pilot light).

To switch the boiler on, push the ON/OFF button. Turn the knob "C" to the summer "☀️" or winter position; a centralised electronic control unit will automatically light the main burner when needed without any intervention from the outside (green LED "A" will illuminate when the burner is on).

If the burner does not light within the pre-set safety time limit, the display will show an error code and the red LED "H" will illuminate.

To reset the ignition system, the reset button RESET must be pressed. Should the system fail to light a second time, check to make sure that the gas cock is open. If the problem persists, contact one of our Authorised Service Centres.

Winter and Summer Operating Modes

In the "winter" operating mode, the boiler will produce both Central Heating and Domestic Hot Water. In the "summer" operating mode, the boiler will produce only Domestic Hot Water.

Using the knob on the control panel, the user can select "winter" or "summer" operating mode. Keeping the knob "C" at the "☀️" position selects the "summer" operating mode. "Winter" operating mode may be selected by positioning the knob "C" between the min. and max. settings.

Adjusting the heating

It is possible to set the temperature of the Central Heating system by adjusting the knob "C". By positioning the indicator somewhere between 1 and 6, a temperature may be obtained which varies from approximately 38°C to about 82°C.

The water temperature in the primary circuit is shown on the display.

External (room) thermostat control

If an external (room) thermostat is installed, it is recommended that the temperature of the Central Heating system be set by means of the knob "C", leaving it at max in order to obtain the best performance from the boiler and to allow the regulation of the room temperature to function efficiently.

Setting the hot water for domestic use

Both in the winter and summer mode, the temperature of the Domestic Hot Water may be adjusted by using knob "E". A delivery temperature for the water may be chosen in a range from 36°C to about 56°C, depending on the flow rate of the water and the position of the knob between the min. and max. settings.

To increase water temperature, turn knob "E" to max. and reduce the water flow rate at the tap.

The water temperature in the primary circuit is shown on the display.

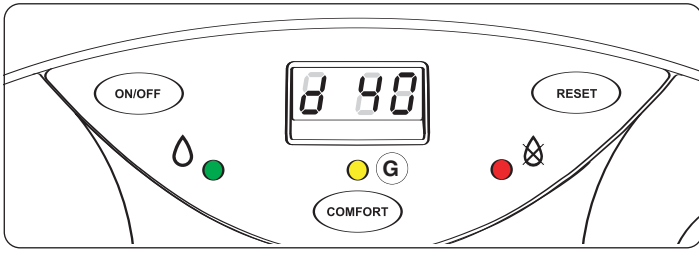

Comfort Function

The supply of water for domestic use can become more convenient by means of the “COMFORT” function, which maintains the secondary exchanger at a preset temperature when the boiler is not running; thereby allowing a quicker delivery of domestic water when required. This function is activated by pressing the COMFORT button on the control panel. When the function is on, a yellow L.E.D. “G” on the control panel will illuminate.

Note: If the “COMFORT” function is on during the pump overrun period, it will be temporarily deactivated. The yellow L.E.D. “G” will remain on to indicate that the boiler will resume the “COMFORT” mode once the pump overrun period is complete. Periodic operation of the appliance will occur regardless of demand on the boiler. This function is normal operation

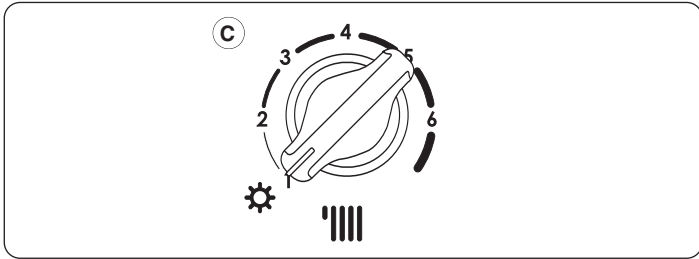

Turning Off the Heating

Installation without an external thermostat:

To turn off the heating, turn the selector knob “C” to “☀”. The boiler will still provide domestic hot water.

Installation with an external thermostat:

To turn off the heating, turn the selector knob “C” to “☀”. The boiler will still provide hot water for domestic use. With an external room thermostat, turn the dial of the thermostat down to the frost setting.



Turning off the boiler

To turn the boiler off, push the button ON/OFF; the display will go off.

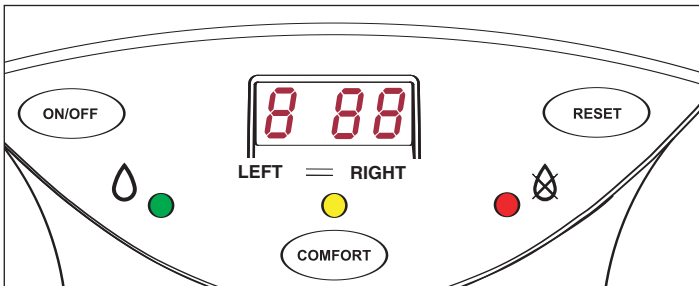

Display: Viewing Normal Functions

When the system is operating, i.e. while the boiler is fulfilling its normal functions, the left-hand display will show a letter indicating the following functions:

- 0 No Request for Heat (Stand By)
- C Central Heating
- c Pump Overrun for Heating
- d Water for Domestic Use
- h Pump Overrun for Water for Domestic Use

The right-hand display (two-digit) shows:

- in heating mode: temperature of heating system flow;
- in domestic hot water mode: temperature of the DHW leaving the boiler

4. USEFUL INFORMATION

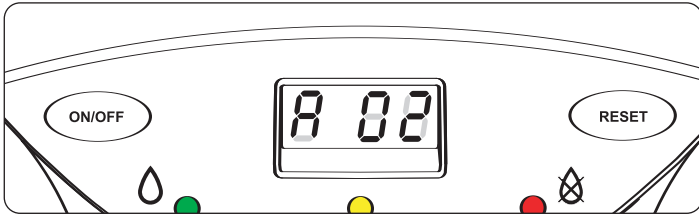
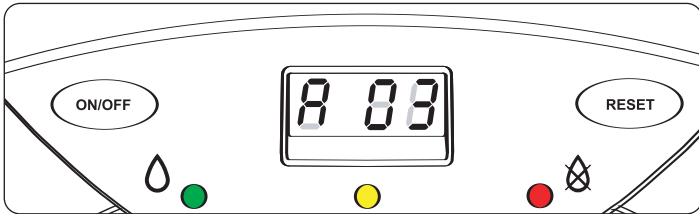
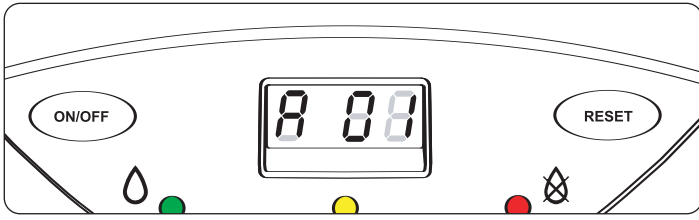

Boiler Shutdown

The boiler is equipped with safety devices which intervene in certain situations to shutdown the boiler. Some of these situations are signalled by the boiler and can be corrected by the user.

Shutdown Due to Ignition Failure

This anomaly is indicated by “A01” on the display. To reset the boiler, press and then release the reset button **RESET**. At this point, the electronic ignition system will attempt to light the burner again.

Should the boiler fail to ignite a second time, check that the external gas cock is open. If the problem persists, contact an Authorised Service Centre.

Shutdown Due to Overheating

This anomaly is indicated by “A 03” on the display. The boiler has shutdown because the safety thermostat detected that the boiler temperature has exceeded the maximum limit.

To reset this state, wait until the boiler has cooled and press the **RESET** button.

If the safety thermostat operates on a frequent basis, contact an Authorised Service Centre.

Shutdown Due to Insufficient Water Circulation

This anomaly is indicated by “A 02” on the display.

One of the possible causes of this shutdown situation could be the lack of water in the boiler or water circulation failure in the primary heating circuit.

Check the system pressure on the pressure gauge “F” and, if it is less than 0.5 bar, try bringing the system pressure up to a mean value of 1.0 bar by opening the water inlet valve (see page 4 for further instructions). Then reset by pressing the **RESET** button.

Other Shutdown Situations

Should a shutdown situation indicated on the left display by the letter E (E 04, E 05, E06,etc.), contact an Authorised Service Centre.

If instead the display shows one of the shutdown situations indicated by the following letters and figures, A 07, A 33, A 97, A 98, A 99, try resetting the boiler by pressing the reset button **RESET**. If the boiler shuts off again, contact an Authorised Service Centre.

Anti-frost device

The boiler is fitted with a device which, in the event that the water temperature falls below 8°C the pump activates and runs until a temperature of 18°C is attained. In the event that the water temperature falls below 3°C, the diverter valve switches to Domestic Hot Water and the burner fires and runs on minimum power until a temperature of 33°C is attained.

This device is only activated when the boiler is operating perfectly and:

- the system pressure is sufficient;
- the boiler is powered electrically;
- gas is being distributed.

IMPORTANT!

DUE TO THE HIGH EFFICIENCY NATURE OF THE APPLIANCE, THE FLUE WILL PRODUCE PLUMES OF CONDENSED WATER VAPOUR, THIS IS NORMAL OPERATION FOR A CONDENSING BOILER.

5. TIME CLOCK

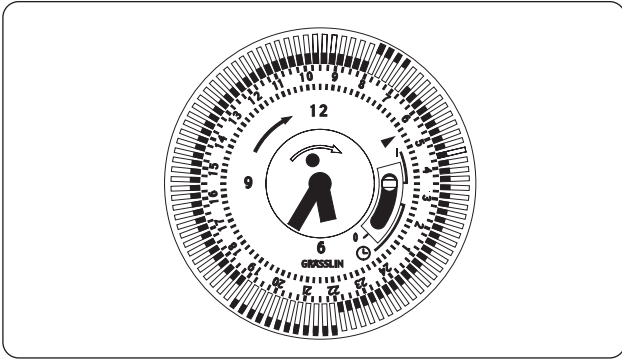

NOTE: the time clock is for central heating control only.

The time clock is provided with 96 switches, called riders, each of which covers a time interval of 15 minutes (four per hour). When a rider is switched from the inside (off setting) to the outside of the clock border (on setting), the circuit is closed (switch on) for a period of 15 minutes and then the boiler starts if the room thermostat (if installed) or the heating thermostat require heat (heating function on).

EXAMPLE

To set the heating of your home in the time interval from 7.00 am to 8.00 am and from 7.00 pm to 10.00 pm every day (see diagram):

- rotate the outer ring of the clock in a clockwise direction until the correct time of day (24h) lines up with the arrow on the clock (at approx. 2 o'clock position);
- **under no circumstances should the minute hand be moved manually;**
- make sure all the switches, i.e. the riders, are placed on the inside of the clock border;
- pull outward the riders for 7.00 am and 8.00 am, and then all riders between these two;
- repeat this for 7.00 pm and 10.00 pm.

Other heating intervals may be set in the same way.

The clock is provided with a selector switch with three positions (see figure):



1. **Position "I" CONSTANT:** in this position, the clock circuit is always closed (switch on), therefore the boiler will constantly be on and will only shut off upon the request of the room thermostat (if installed) or the heating thermostat;



2. **Position "O" HEATING OFF:** in this position, the clock circuit is always open (switch off) and the boiler will therefore never ignite for heating;



3. **"Central" Position PROGRAMMING ACTIVE:** in this position, the programming set by the user is active.

6. DIGITAL PROGRAMMER

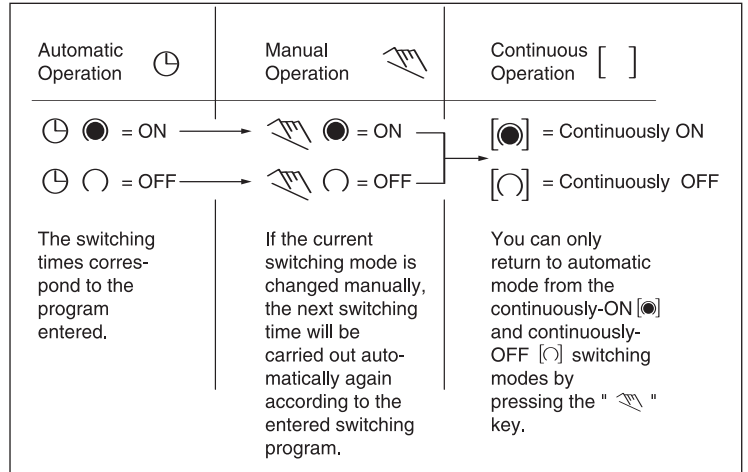
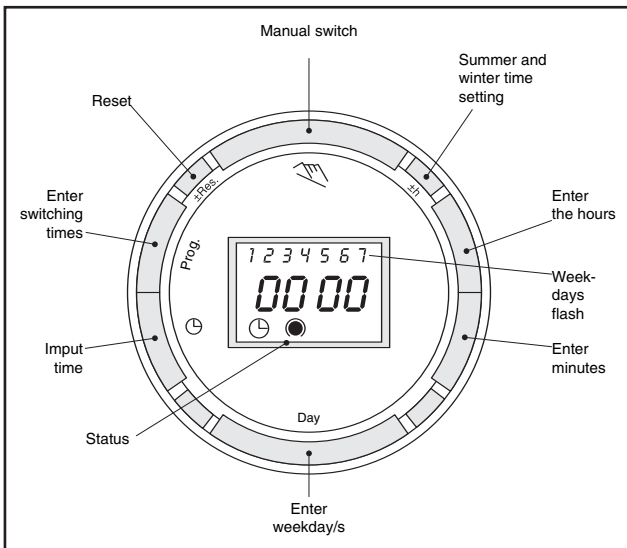

Operating the time switch

The steps marked with the symbol "►" are necessary to carry out a switching program.

► Preparing for Operation

Activate the "Res" switch (=RESET) to reset the time switch to its default setting (activate using a pencil or similar pointed instrument). Do this:

- every time you wish to "reset" the time switch
- to erase all switching times and the current time of day.

After approximately two seconds the following display appears:

► Enter current time and weekday

- Keep the "⌚" key pressed down
- During the summer time period press the +/- 1h key once.
- Enter the hour using the "h" key
- Enter the minutes using the "m" key
- Enter the day using the "Day" key
- 1 = "Monday".....7 = Sunday
- Release the "⌚" key.

► Entering the switching times

You have 20 memory locations available. Each switching time takes up one memory location.

Keep pressing the "Prog" key until a free memory location is shown in the display "--:--".

Programme ON or OFF with the "" key:

"○" = OFF; "●" = ON

Enter the hour using "h"

Enter the minutes using "m"

If a switching command is to be carried out every day (1 2 3 4 5 6 7) then store using the "⌚" key, otherwise select the day(s) it is carried out by using the "Day" key.

When the day selection is left blank, the programmed switching instruction operates at the same time every day

1 2 3 4 5 6 = Monday – Saturday

1 2 3 4 5 = Monday – Friday

6 7 = Saturday – Sunday

Selection of single days: 1 = Mon. 2 = Tues.

Save the switching time with the "⌚" key.

The time switch enters the automatic operating mode and displays the current time of day.

Begin any further entry of a switching time with the "Prog" switch. If your entry is incomplete, the segments not yet selected will blink in the display. After programming is completed, and you return the time clock to the current time display with the "⌚" key, the time clock will not activate any switching instruction required for the current time. You may need to manually select the desired switching state with the "" key. Thereafter, as the unit encounters further switching instructions in the memory in real time, it will correctly activate all subsequent switching instructions.

Manual Override Switch ""

With the "" you can change the current setting at any time. The switching program already entered is not altered.

Reading the programmed switching times

Pressing the "Prog" key displays the programmed switching times until the first free memory location appears in the display "--:--".

If you now press the "Prog" key once again, the number of free memory locations will be displayed, e.g. "18". If all memory locations are occupied, the display "00" appears.

Changing the programmed switching times

Press the "Prog" key repeatedly until the switching time you want to change is displayed. You can now enter the new data. See point "Entering the switching times".

Notes on storing switching times:

If you end your entry of the switching times by pressing the "Prog" key, then the switching time you have entered will be stored and the next memory location displayed.

In addition, a complete switching command is stored **automatically** after around 90 seconds provided **no other** key is pressed. The time switch then enters the automatic operating mode and displays the current time again.

Deleting individual switching times

Press the "Prog" key repeatedly until the switching time you wish to delete is shown in the display. Then set to "--" using the "h" or "m" key and keep the "⌚" key pressed down for around 3 seconds. The switching time is now erased and the current time is displayed.

AM / PM time display

If you press the "+/-1h" and "h" keys at the same time, the time display switches into the AM/PM mode.

Manufacturer: **Merloni TermoSanitari SpA - Italy**

Commercial subsidiaries: **MTS (GB) Limited**
MTS Building
Hughenden Avenue
High Wycombe
Bucks HP13 5FT
Telephone: (01494) 755600
Fax: (01494) 459775
Internet: www.mtsgroup.com/uk
E-mail: info@uk.mtsgroup.com
Technical Advice: 0870 241 8180
Customer Service: 0870 600 9888

MTS Heating Limited
Damastown Industrial Park
Damastown Avenue
Mulhuddart
Dublin 15
Telephone: (01) 810 3723
Fax: (01) 810 3727
Internet: www.mtsgroup.com/ie
E-mail: info@ie.mtsgroup.com
Technical Advice: (01) 437 0121
Customer Service: (01) 437 0121