

User's manual

# E-Combi 24/30/38

# E-System 24/30

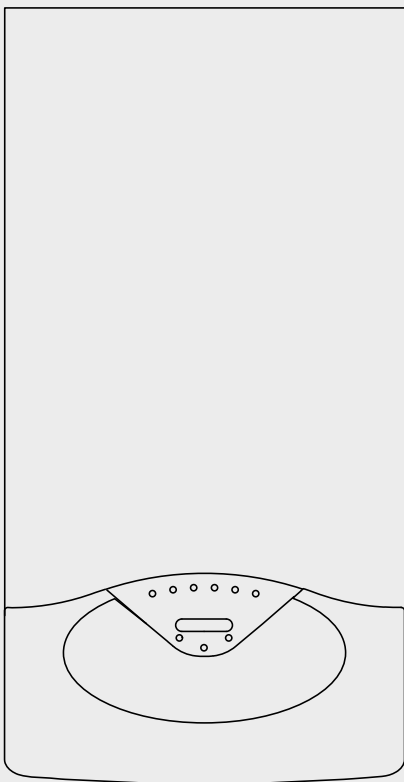

CONDENSING WALL HUNG  
COMBINATION BOILER

**G.C.N : 47 - 116 - 62 (24 kW)**

**G.C.N : 47 - 116 - 63 (30 kW)**

**G.C.N : 47 - 116 - 64 (38 kW)**

CONDENSING WALL HUNG  
O.H. BOILER

**G.C.N : 41 - 116 - 34 (24 kW)**

**G.C.N : 41 - 116 - 35 (30 kW)**

Country of destination GB, IE

**kiwa**  
approved  
product



Dear Customer,

Thank you for choosing an ARISTON boiler.

We guarantee that your boiler is a reliable and technically sound product. This manual provides detailed instructions and recommendations for the correct use of the appliance.

Remember to keep this manual in a safe place for future reference i.e. by the boiler.

Your local ARISTON Servicing Centre is at your complete disposal for all requirements.

**The installation and first ignition of the boiler must be performed by qualified personnel in compliance with current national regulations regarding installation, and in conformity with any requirements established by local authorities and public health organisations.**

**After the boiler has been installed, the installer must ensure that the end user receives the declaration of conformity and the operating manual, and should provide all necessary information as to how the boiler and the safety devices should be handled.**

This appliance is designed to produce central heating and domestic use only.

It should be connected to a heating system and a distribution network for domestic hot water, both of which must be compatible with its performance and power levels.

The use of the appliance for purposes other than those specified is strictly forbidden. The manufacturer cannot be held responsible for any damage caused by improper, incorrect and unreasonable use of the appliance or by the failure to comply with the instructions given in this manual.

Installation, maintenance and all other interventions must be carried out in full conformity with the governing legal regulations and the instructions provided by the manufacturer. Incorrect installation can harm persons, animals and possessions; the manufacturing company shall not be held responsible for any damage caused as a result.

In the event of any maintenance or other structural work in the immediate vicinity of the ducts or flue gas exhaust devices and their accessories, switch the appliance off by switching the external bipolar switch to the "OFF" position and shutting off the gas valve.

When the work has been completed, ask a qualified technician to check the efficiency of the ducting and the devices.

If the boiler should be out of use for a prolonged period, it is recommended that the electrical power supply be disconnected and that the external gas cock be closed. If low temperatures are expected, the boiler and system pipe work should be drained in order to prevent frost damage.

Turn the boiler off and turn the external switch "OFF" to clean the exterior parts of the appliance.

Do not allow children or inexperienced persons to use the appliance without supervision.

### CE labelling

The CE mark guarantees that the appliance conforms to the following directives:

- **90/396/CEE**  
relating to gas appliances
- **2004/108/CEE**  
relating to electromagnetic compatibility
- **92/42/CEE**  
relating to energy efficiency
- **2006/95/CEE**  
relating to electrical safety

### GUARANTEE

The manufacturer's guarantee is for 2 years from the date of purchase. The guarantee is invalidated if the appliance is not installed in accordance with the recommendations made herein or in a manner not approved by the manufacturer. To assist us in providing you with an efficient after sales service, please return the guarantee registration card enclosed with the boiler without delay.

Ariston only obligation under the guarantee will be to repair or replace the faulty appliance at Ariston discretion. This will be carried out where the fault arises from defects within the appliance, caused either by material or workmanship of the manufacturer.

This guarantee does not protect malfunction or damage arising from incorrect installation, commissioning or maintenance procedures as laid out in the installation and servicing manual, inefficient flue system, poor or incorrect electricity, wrong gas supply or pressure, tampering by inexperienced persons and any other cause not directly due to manufacture.

ARISTON (GB) Limited cannot accept responsibility for any cost arising from repair or maintenance carried out by any third party.

Repair under the guarantee does not affect the expiry date of the guarantee. The guarantee on parts and appliances which are exchanged ends when the guarantee on the original appliance expires.

This guarantee does not affect your statutory rights.

You must have your boiler serviced at the end of the first year to validate your guarantee for the second year and ensure the Benchmark serv. internal Record is completed.

### The Benchmark Scheme

ARISTON is a licensed member of the Benchmark Scheme which aims to improve the standards of installation and commissioning of domestic heating and hot water systems in the UK and to encourage regular servicing to optimise safety, efficiency and performance.

Benchmark is managed and promoted by the Heating and Hotwater Industry Council. For more information visit [www.centralheating.co.uk](http://www.centralheating.co.uk)

Please ensure that the installer has fully completed the Benchmark Checklist on the inside back pages of the installation instructions supplied with the product and that you have signed it to say that you have received a full and clear explanation of its operation. The installer is legally required to complete a commissioning checklist as a means of complying with the appropriate Building Regulations (England and Wales).



All installations must be notified to Local Area Building Control either directly or through a Competent Persons Scheme. A Building Regulations Compliance Certificate will then be issued to the customer who should, on receipt, write the Notification Number on the Benchmark Checklist.

This product should be serviced regularly to optimise its safety, efficiency and performance. The service engineer should complete the relevant Service Record on the Benchmark Checklist after each service.

The Benchmark Checklist may be required in the event of any warranty work and as supporting documentation relating to home improvements in the optional documents section of the Home Information Pack.

### Safety regulations



Key to symbols:

-  Failure to comply with this warning implies the risk of personal injury, in some circumstances even fatal
-  Failure to comply with this warning implies the risk of damage, in some circumstances even serious, to property, plants or animals.

#### **Do not perform operations which involve opening the appliance.**

-  Electrocutation from live components.  
Personal injury caused by burns due to overheated components, or wounds caused by sharp edges or protrusions.



#### **Do not perform operations which involve removing the appliance from its installation space .**

-  Electrocutation from live components.
-  Flooding caused by water leaking from disconnected piping.
-  Explosions, fires or intoxication caused by gas leaking from disconnected piping.



#### **Do not damage the power supply cable.**

-  Electrocutation from live uninsulated wires.

#### **Do not leave anything on top of the appliance.**

-  Personal injury caused by an object falling off the appliance as a result of vibrations.
-  Damage to the appliance or items underneath it caused by the object falling off as a result of vibrations.

#### **Do not climb onto the appliance.**

-  Personal injury caused by the appliance falling.
-  Damage to the appliance or any objects underneath it caused by the appliance falling away from its installation space.

#### **Do not climb onto chairs, stools, ladders or unstable supports to clean the appliance.**

-  Personal injury caused by falling from a height or cuts (stepladders shutting accidentally).

#### **Do not attempt to clean the appliance without first switching it off and turning the external switch to the OFF position.**

-  Electrocutation from live components.

#### **Do not use insecticides, solvents or aggressive detergents to clean the appliance.**

-  Damage to plastic and painted parts.

#### **Do not use the appliance for any use other than normal domestic use.**

-  Damage to the appliance caused by operation overload.  
Damage caused to objects treated inappropriately.

#### **Do not allow children or inexperienced individuals to operate the appliance.**

-  Damage to the appliance caused by improper use.

#### **If you detect a smell of burning or smoke coming from the appliance, disconnect it from the electricity supply, turn off the main gas valve, open all windows and call for assistance.**

-  Personal injury caused by burns, smoke inhalation, intoxication.

#### **If there is a strong smell of gas, turn off the main gas valve, open all windows and call for assistance.**

-  Explosions, fires or intoxication.

This appliance is not intended for use by persons (including children) with reduced physical, sensory or mental capabilities, or lack of experience and knowledge, unless they have been given supervision or instruction concerning use of the appliance by a person responsible for their safety.

Children should be supervised to ensure that they do not play with the appliance.

## Control panel

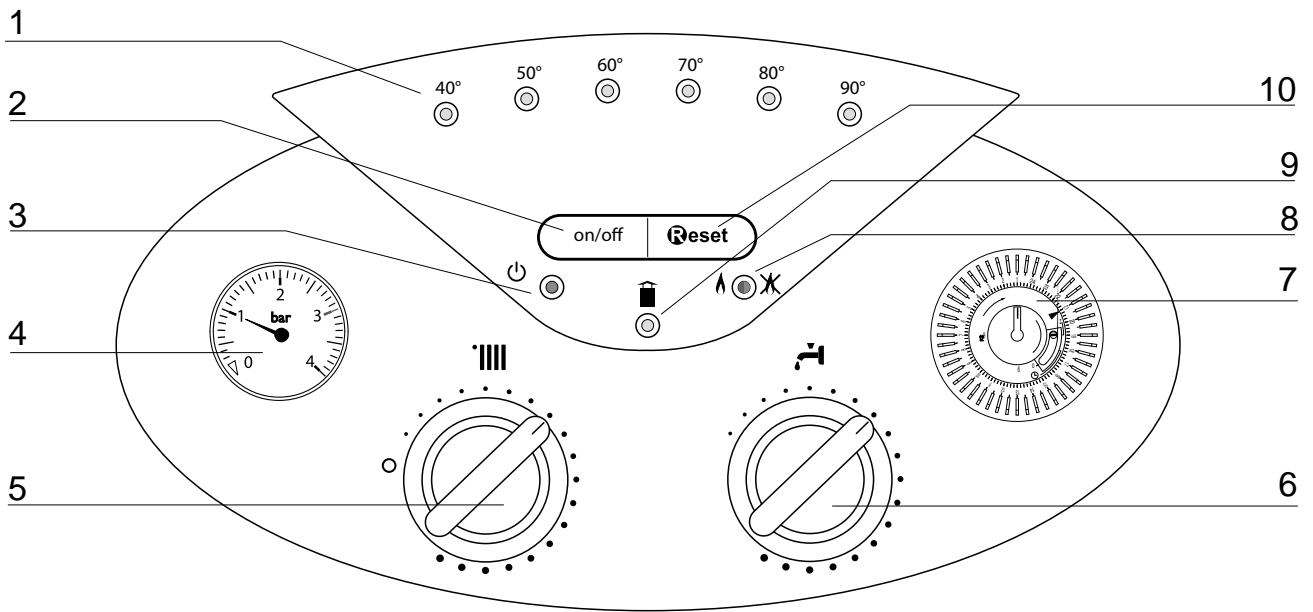

### E-SYSTEM

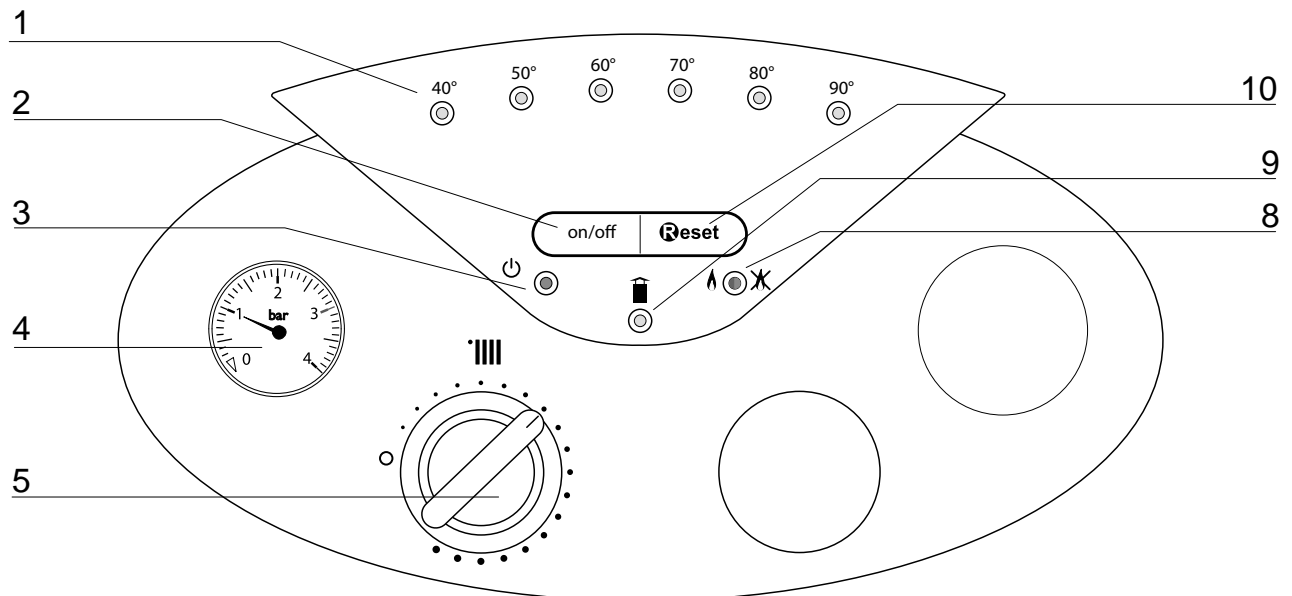

#### Legend :

- 1. Green indicator : CH temperature and error indicator
- 2. ON/OFF button
- 3. Green indicator : ON/OFF
- 4. Pressure gauge
- 5. Winter / Summer switch - Heating temperature regulation knob
- 6. Domestic Hot Water adjustment knob (E-Combi models)
- 7. Time clock (E-Combi models)
- 8. Green indicator : flame ON  
Red indicator : lockout light
- 9. Yellow indicator : flashing error light
- 10. RESET button

**Initial operating procedures**

**Filling instructions**

Check the water pressure on the pressure gauge regularly and make sure that the figure is between 0.6 and 1.5 bar when the system is cold. If the pressure is just under the minimum value, re-establish the correct pressure by using the filling loop.

If the pressure drops very frequently, there may be a water leak at some point in the system. If this is the case a plumber should be contacted

**Ignition procedure**

Press the ON/OFF button on the control panel to switch on the boiler. The green LED 3 will illuminate indicating that the boiler is ready to operate.

The electronic control unit will ignite the burner, without any manual intervention but in response to the request for Domestic Hot Water or Central Heating. If, after approximately 10 seconds, the burner has not ignited, the boiler's safety devices will shut off the gas and the red LED 8 illuminates. To reset the ignition system, the Reset button 10 must be pressed and released.

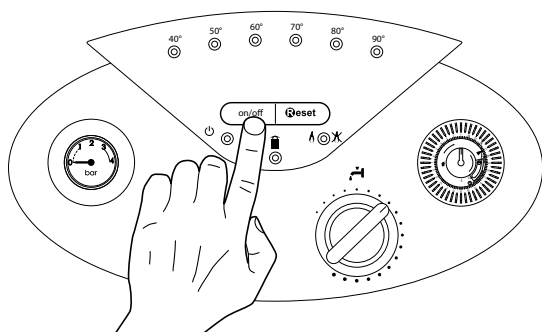

Should the boiler fail to ignite a second time, check that the external gas cock is open. If the problem persists, contact an Authorised Service Centre.

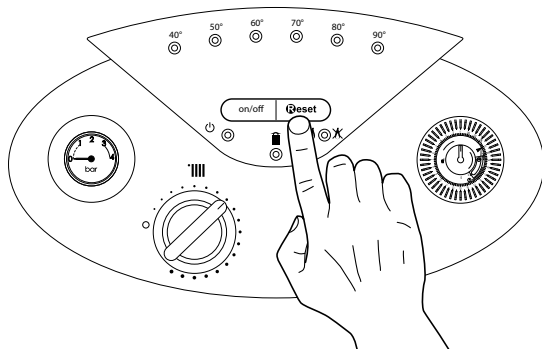

**Winter or summer operating modes**

In the "winter" operating mode, the boiler will produce both Central Heating and Domestic Hot Water. In the "summer" operating mode, the boiler will produce only Domestic Hot Water. Using the knob on the control panel, the user can select "winter" or "summer" operating mode. Keeping the knob 5 at the 0 position selects the "summer" operating mode. "Winter" operating mode may be selected by positioning the knob 5 between the min. and max. settings.

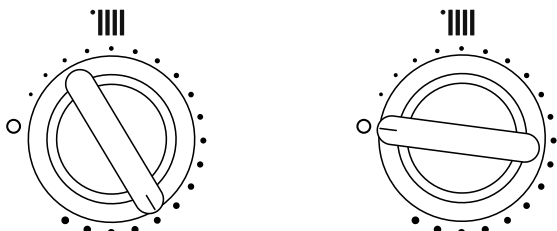

**Adjusting the heating**

It is possible to set the temperature of the heating water by adjusting the knob 5. By positioning the indicator somewhere between min. and max. A temperature may be obtained which varies from approximately 40°C to approximately 82°C.

The water temperature in the primary circuit may be checked by means of the green leds 1.

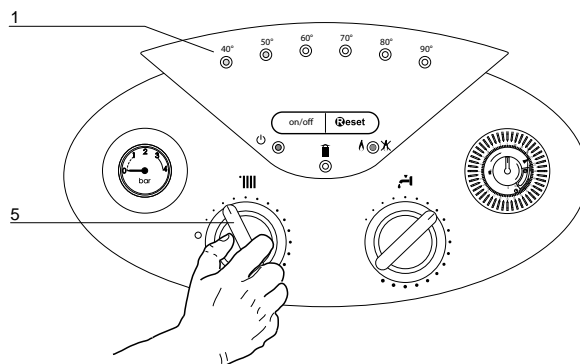

**Domestic Hot Water temperature adjustment - E-COMBI**

It is possible to set the temperature of the domestic hot water by adjusting the knob 6. A temperature may be obtained which varies from approximately 36°C to approximately 60°C.

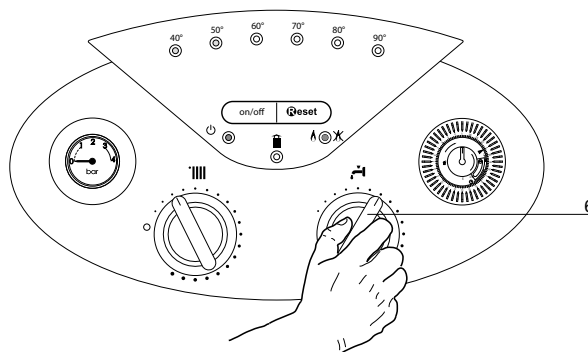

**Switching off the heating**

To switch off the heating mode turn the button 5 to the position 0. The boiler will now only produce Domestic Hot Water.

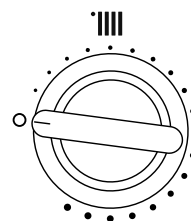

**Stand by**

To switch off the boiler press the ON/OFF button 2. The green LED 3 will go off.

Switch off the boiler completely by switching the external electrical switch to the OFF position.

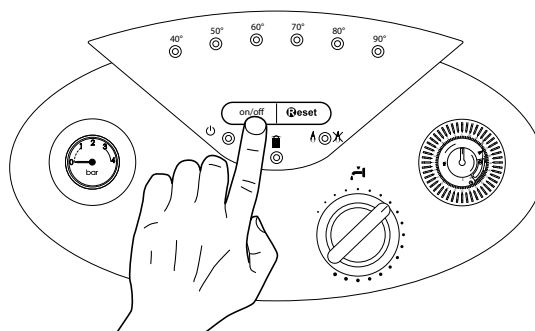

## Clock Instructions - E-COMBI

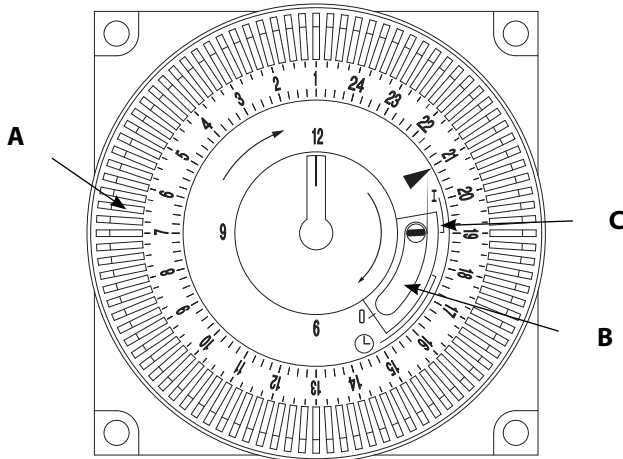

### 1. General layout

The mechanical clock covers a 24 hour period. Each tappet represents 15 minutes **A**. An override switch is located on the clock **B**.

### 2. To set the time

To set the time of day, grasp the outer edge of the dial and turn slowly clockwise until the correct time is lined up with the arrow **C**.

### 3. To Set the "On" and "Off" times

The clock uses a 24hours system. e.g. 8 = 8.00 am and 18 = 6.00 pm "ON" periods are set by sliding all tappets between the "ON" time and the "OFF" time to the outer edge of the dial. The tappets remaining at the centre of the dial are the "OFF" periods.

### 4. For operation

Put the selector switch **B** to the  symbol to control the central heating by the clock. Put the switch **B** to "I"

to select permanent operation or to "0" to turn the central heating off permanently.

## Boiler protection devices

The boiler is protected from malfunctioning by means of internal checks performed by the electronic microprocessor P.C.B., which stops the boiler from operating if necessary.

In the event of the boiler being shut off in this manner, the LED shows the type of shut-off and the reason behind it.

There are two types of shut-off:

### Safety shut-off

This type of error is "volatile", which means that the boiler starts up again automatically as soon as the problem which caused the shut-off is removed; the yellow LED **9** flashes and the C.H. temperature LED **1** indicate the error code. (see table)

As soon as the cause of the shut-off disappears, the boiler starts up again and continues to operate normally.

**If the boiler still indicates a safety shut-off, switch it off. Make sure the external electric switch is in the OFF position and contact a qualified technician.**

### Shutdown due to insufficient water circulation

If the green leds **1** flash and the boiler is off, one possible cause for this state is an insufficient pressure of water in the system - green LED 40-50 blink. Check the water pressure on the pressure gauge **4** and make sure that is between

0.6 and 1.5 bar when the system is cold. If the pressure is just under the minimum refill the system by opening the valve under the boiler.

If the pressure drops very frequently, there may be a water leak at some point in the system. If this is the case a plumber should be contacted.

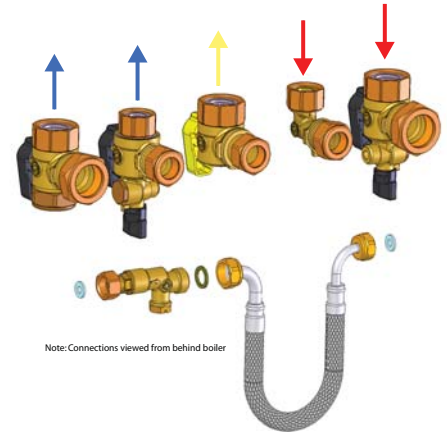

Note: Connections viewed from behind boiler



### Operation shutdown

This type of error is "non-volatile", which means that it is not removed automatically (the red LED **8** will illuminate and the C.H. temperature LED **1** will indicate the error code). In this case the boiler does not restart automatically, but it may be reset by pressing the  button. If the problem manifests itself again after several attempts to reset the appliance, contact a qualified technician.

### Important

**If this shutdown occurs frequently, contact an authorised service centre for assistance. For safety reasons, the boiler will allow a maximum of 5 reset operations to take place in 15 minutes (individual presses of the button). If the shutdown is occasional or an isolated event, this is not a problem.**

Table summarising error codes

Green Leds Temperature indicator								Reset	Description	Note ○ = flashing light ● = lit
40	50	60	70	80	90	yellow	red			
					●		●	X	Overheat	
●	●						●	X	Insufficient circulation	
	○	○				○			Insufficient water (request filling)	
		○	○			○			C.H. Flow temp. probe circuit open / short circuit	
			○	○		○			C.H. Return temp. probe circuit open / short circuit	
○		○				○			External sensor circuit open / short circuit	
○			○			○			Floor thermostat contact open	
		●	●				●	X	Heating delivery probe problem	
○	○					○			Insufficient circulation	
			○			○			EEPROM error	
				○		○			Communication error	
○	○	○	○	○		○			Too many (> 5) resets in 15 minutes	
				●			●	X	Main P.C.B. error	
○		○				○			Room sensor circuit open / short circuit	
							●	X	No flame detected	
	○	○	○			○			Flame detected with gas valve closed	
		●	●	●			●	X	Flame lift	
○		○		○		○			1st Ignition Failed	
	○	○		○		○			2nd Ignition Failed	
		○	○	○		○			Flame cut-off	
			●	●			●	X	Thermofuse open	
	●	●					●	X	Fan speed error	

**Anti-frost Device.**

When the electrical supply is turned on, the anti-frost function acts on the central heating flow temperature probe, independently from other safety devices.

If the primary circuit temperature is between 3°C and 8°C the pump will run (with the diverter valve switching between central heating and hot water every 1 minute) until the temperature reaches > 9°C.

If the flow temperature remains between 3°C and 8°C the pump will continue to run for a maximum of 20 minutes unless a temperature above > 9°C is detected in the central heating flow, after this the burner will fire (heating position) until a temperature of > 30°C is detected.

If the central heating flow temperature is < 3°C, the burner will fire (heating position) at minimum power until the temperature reaches > 30°C, the burner will go out.

If lockout is caused by overheat the burner will not fire but the pump will continue to run (heating position).

The anti-frost device activates only when (with the boiler operating correctly):

- the system pressure is correct;
- the boiler is electrically powered;
- there is a supply of gas.

**Change of gas type**

Our boilers are designed to function either with Natural Gas (methane) or L.P.G. gas. If you need to change from one gas to the other, one of our Authorised Service Centres must be contacted to convert the appliance.

**Maintenance**

Schedule an annual maintenance check-up for the boiler with a competent person.

Correct maintenance generally results in savings in the cost of running the system.

Failure to arrange an annual service for the appliance will invalidate the second year of the manufacturer's guarantee.

**Ariston Thermo UK Ltd**

Hughenden Avenue

High Wycombe

Bucks HP13 5FT

Telephone: (01494) 755600

Fax: (01494) 459775

Internet: [www.aristonthermo.co.uk](http://www.aristonthermo.co.uk)

Technical Advice: 0870 241 8180

Customer Service: 0870 600 9888

Professional Team Limited

Suites 9 & 10, Plaza 256

Blanchardstown Corporate Park 2

Ballycoolin

Dublin 15

Telephone: (01) 810 3723

Fax: (01) 810 3727

Internet: [www.aristonthermo.ie](http://www.aristonthermo.ie)

Technical Advice: (01) 437 0121

Customer Service: (01) 437 0121