

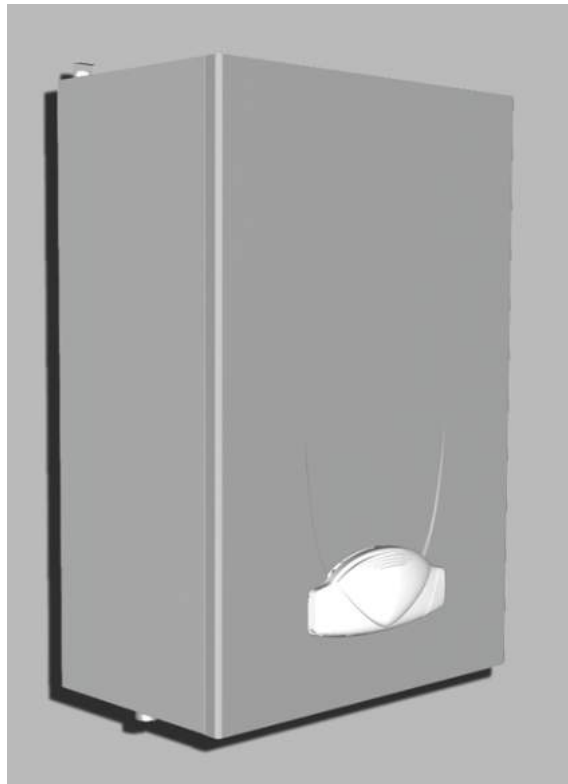

Lamborghini
CALORECLIMA

CERTIFIED COMPANY ISO 9001



cod. 3540S060 – 04/2010 (Rev. 00)



EXTREMA C

INSTRUCTIONS FOR USE, INSTALLATION AND MAINTENANCE
FOR THE UNITED KINGDOM AND EIRE



- Carefully read the warnings in this instruction booklet since they provide important information on safe installation, use and maintenance.
- This instruction booklet is an integral part of the product and must be carefully kept by the user for future reference.
- If the unit is sold or transferred to another owner or if it is to be moved, always make sure that the booklet accompanies the boiler so that it can be consulted by the new owner and/or installer.
- Installation and maintenance must be carried out by professionally qualified personnel, according to current regulations and the manufacturer's instructions.
- Incorrect installation or poor maintenance can cause damage or physical injury. The manufacturer declines any responsibility for damage caused by errors in installation and use or by failure to follow the manufacturer's instructions.
- Before carrying out any cleaning or maintenance operation, DISCONNECT AND ISOLATE the boiler from the electrical power supply.
- In case the unit breaks down and/or functions poorly, deactivate it, do not make any attempt to repair it or directly intervene. Contact professionally qualified personnel. Any repair/replacement of products must only be carried out by qualified professional personnel using exclusively genuine parts. Failure to comply with the above could affect the safety of the unit.
- Periodical maintenance carried out by qualified personnel is essential for guaranteeing good operation of the unit.
- This unit must only be used for the purpose for which it was designed. Any other use is considered improper and therefore hazardous.
- After removing the packing, check the integrity of the contents. Packing materials must not be left within the reach of children as they are potentially hazardous.
- In case of doubt do not use the unit, and contact the supplier.
- The images shown in this manual are a simplified representation of the product. In this representation there may be slight, unimportant differences with the supplied product.
- Whilst every effort is taken to ensure the accuracy of the information contained within these instructions, the details are offered in good faith and the Manufacturer accepts no liability for matters arising as a result of errors and/or omissions.
- Due to the Manufacturers continuous product research and development, the details contained in this manual may not truly reflect the actual product.

	This symbol indicates "Caution" and is placed next to all safety warnings. Strictly follow these instructions in order to avoid danger and damage to persons, animals and things.
	This symbols calls attention to a note or important notice.



Declaration of conformity

Manufacturer declares that this unit complies with the following EU directives:

- Gas Appliance Directive 90/396
- Efficiency Directive 92/42
- Low Voltage Directive 73/23 (amended by 93/68)
- Electromagnetic Compatibility Directive 89/336 (amended by 93/68)

1 Instructions	4
1.1 Introduction.....	4
1.2 Control panel	4
1.3 Lighting and turning off.....	6
1.4 Adjustments.....	7
2 Installation	10
2.1 General Instructions	10
2.2 Place of installation	11
2.3 Plumbing connections	11
2.4 Gas connection	13
2.5 Electrical connections.....	13
2.6 Flue system	14
2.7 Condensate drain connection.....	19
3 Service and maintenance.....	21
3.1 Adjustments.....	21
3.2 Start-up.....	22
3.3 Commissioning instructions	22
3.4 Routine servicing, maintenance & repair.....	24
3.5 Troubleshooting.....	26
4 Technical data and characteristics	28
4.1 Dimensions and connections	28
4.2 General view and main components	29
4.3 Water circuit	30
4.4 Technical data table	31
4.5 Diagrams	32
4.6 Wiring diagram	33



1. Instructions

1.1 Introduction

Dear Customer

Thank you for choosing an **EXTREMA** wall-mounted boiler featuring **LAMBORGHINI** advanced design, cutting-edge technology, high reliability and quality construction. Please read this manual carefully since it provides important information on safe installation, use and maintenance.

EXTREMA is a high-efficiency, low emissions **premix condensing** generator for heating and hot water production, running on natural gas or LPG and equipped with a microprocessor control system.

The **boiler shell** consists of a stainless steel exchanger and a **premix burner** equipped with electronic ignition and ionisation flame control, a modulating speed fan, modulating gas valve and an energy saving modulating pump.

The **sealed chamber** unit is suitable for indoor installation or outdoors in a partially protected place (according to EN 297/A6) with temperatures to -5°C.

1.2 Control panel

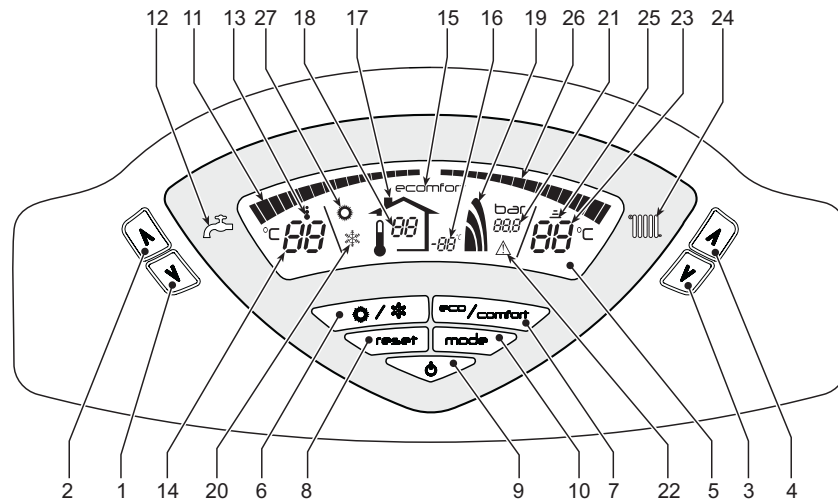

fig. 1 - Control panel

Key

- | | |
|---|--|
| 1 = DHW temperature setting decrease button | 16 = External sensor temperature (with optional external sensor) |
| 2 = DHW temperature setting increase button | 17 = Appears on connecting the external sensor or the Remote Timer Control (optionals) |
| 3 = Heating system temperature setting decrease button | 18 = Room temperature (with optional Remote Timer Control) |
| 4 = Heating system temperature setting increase button | 19 = Burner lit and actual power (blinking during "Flame protection" function) |
| 5 = Display | 20 = Winter mode |
| 6 = Summer / Winter mode selection button | 21 = Heating system pressure |
| 7 = Economy / Comfort mode selection button | 22 = Fault |
| 8 = Reset button | 23 = Heating delivery temperature / setting (blinking during "pump overrun" function) |
| 9 = Unit On / Off button | 24 = Heating symbol |
| 10 = "Sliding Temperature" menu button | 25 = Heating mode |
| 11 = Set DHW temperature reached | 26 = Set heating delivery temperature reached |
| 12 = DHW symbol | 27 = Summer mode |
| 13 = DHW mode | |
| 14 = DHW outlet temperature / setting (blinking during "pump overrun" function) | |
| 15 = Eco (Economy) or Comfort mode | |

Indication during operation

Heating (fig. 2)

A heating demand (generated by the Room Thermostat or Remote Timer Control) is indicated by flashing of the hot air symbol (details 24 and 25 of fig. 1).

The display (detail 23 - fig. 1) shows the actual heating delivery temperature and the message "d2" during heating standby time.

The heating graduation marks (detail 26 - fig. 1) light up as the heating sensor temperature reaches the set value.

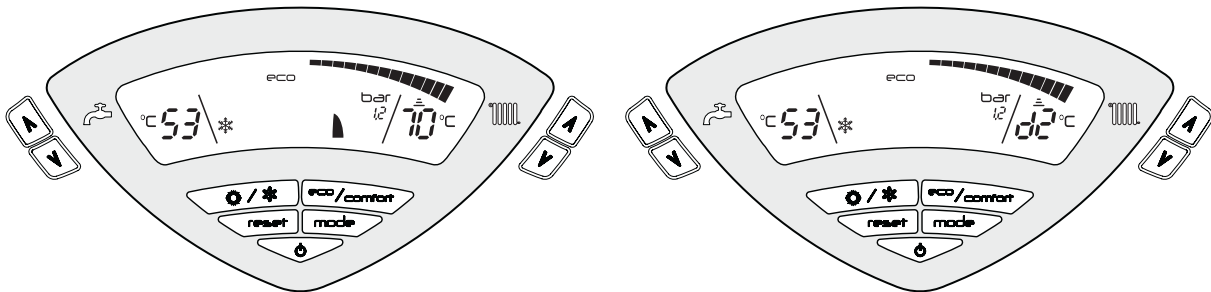

fig. 2

Domestic hot water (DHW) fig. 3

A DHW demand (generated by drawing domestic hot water) is indicated by flashing of the hot water symbol (details 12 and 13 of fig. 1).

The display (detail 14 - fig. 1) shows the actual hot water outlet temperature and the message "d1" during DHW standby time.

The DHW graduation marks (detail 11 - fig. 1) light up as the DHW sensor temperature reaches the set value.

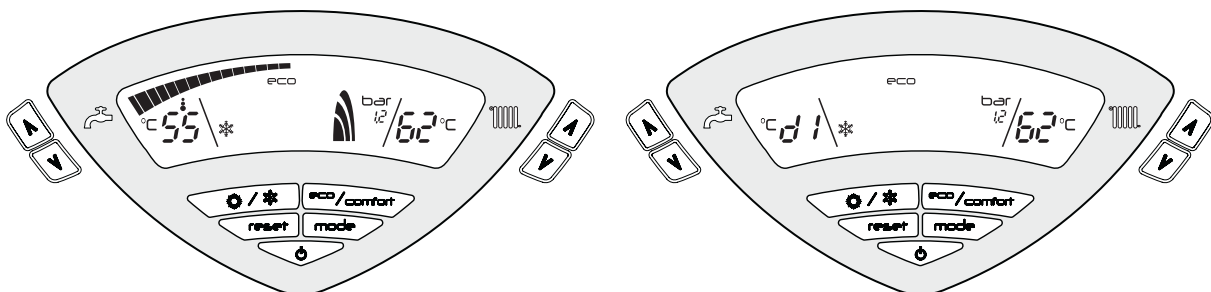

fig. 3

Comfort (fig. 4)

A Comfort demand (for maintaining the temperature inside the boiler) is indicated by flashing of the COMFORT symbol (details 15 and 13 - fig. 1). When in Comfort mode, the DHW within the boiler is kept warm for rapid delivery to the taps.

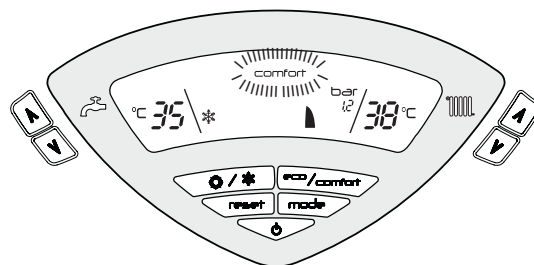

fig. 4

1.3 Lighting and turning off

Boiler not electrically powered (fig. 5)



The frost protection system does not work when the power and/or gas to the unit are turned off. To avoid damage caused by freezing during long idle periods in winter, it is advisable to drain all water from the boiler, DHW circuit and system; or drain just the DHW circuit and add a suitable antifreeze to the heating system.

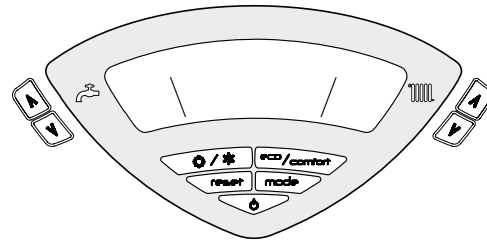

fig. 5 - Boiler not electrically powered

Boiler lighting (fig. 6)

Switch on the power to the unit.

- For the following 120 seconds the display will show FH which identifies the heating system air venting cycle.
- During the first 5 seconds the display will also show the PCB software version.
- Open the gas cock ahead of the boiler.
- When the message FH disappears, the boiler is ready to operate automatically whenever domestic hot water is drawn or in case of a room thermostat demand.

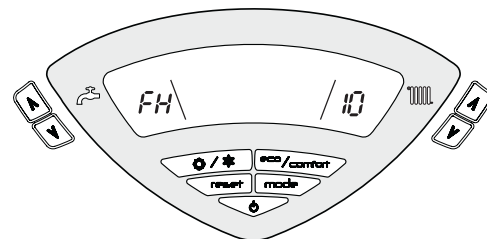

fig. 6 - Boiler lighting

Turning the boiler off (fig. 7)

Press the **on/off** button (detail 9 - fig. 1) for 1 second.

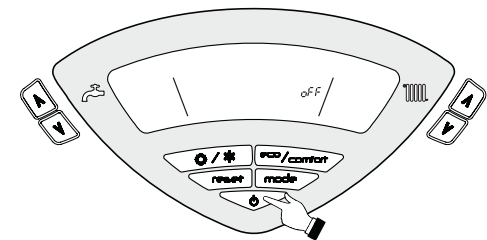

fig. 7 - Turning the boiler off

When the boiler is turned off, the PCB is still powered. Domestic hot water and heating are disabled. The frost protection system remains activated.

To relight the boiler, press the **on/off** button (detail 9 - fig. 1) again for 1 second.

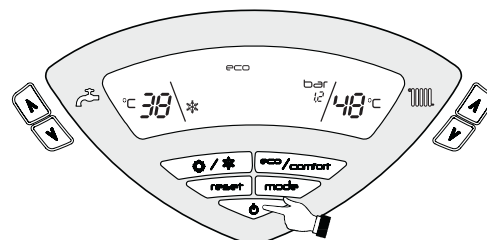

fig. 8 - Relighting the Boiler

The boiler will be immediately ready to operate whenever domestic hot water is drawn or in case of a room thermostat demand.

1.4 Adjustments

Summer/Winter Switchover (fig. 9)

Press the **summer/winter** button (detail 6 - fig. 1) for 1 second.

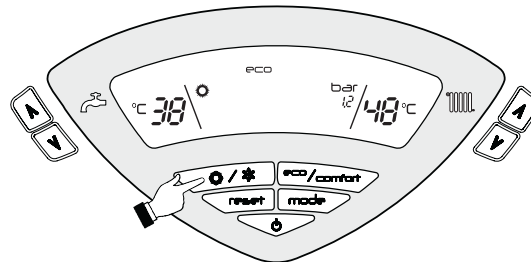

fig. 9

The display activates the Summer symbol (detail 27 - fig. 1): the boiler will only deliver domestic hot water. The frost protection system remains activated.

To deactivate the Summer mode, press the **summer/winter** button (detail 6 - fig. 1) again for 1 second.

Heating temperature setting (fig. 10)

Use the heating buttons (details 3 and 4 - fig. 1) to adjust the temperature from a min. of 20°C to a max. of 90°C.

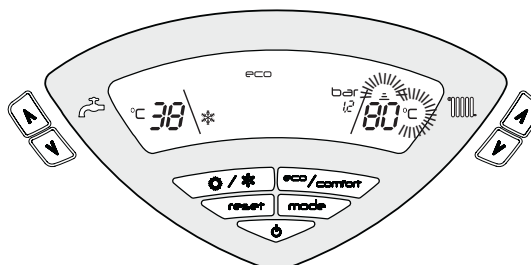

fig. 10

DHW temperature adjustment (fig. 11)

Operate the DHW buttons (details 1 and 2 - fig. 1) to adjust the temperature from a min. of 40°C to a max. of 55°C.

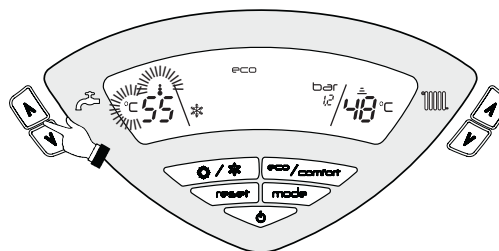

fig. 11

Room temperature adjustment (with optional room thermostat)

It is normal practise for a room thermostat to be connected to the boiler. The room thermostat will control the system to the desired room temperature and if it is a programmable type, it will allow for different temperature levels to be set throughout the day. The boiler will modulate its output to maintain the required room temperature.

Please refer to the specific instructions for the room thermostat for further guidance.

ECO/COMFORT selection

The unit has a function that ensures a high domestic hot water delivery speed and maximum comfort for the user. When the device is activated (COMFORT mode), the water contained in the boiler is kept hot, therefore ensuring rapid availability of hot water on opening the tap, without waiting times.

The device can be deactivated by the user (ECO mode) by pressing the **eco/comfort** button (detail 7 - fig. 1). To activate the COMFORT mode, press the **eco/comfort** button (detail 7 - fig. 1) again.

Outside Temperature Compensation (O.T.C)

When the optional external sensor is installed, the control panel display (detail 5 - fig. 1) shows the actual outside temperature detected by the external sensor. In this mode, the heating system temperature is adjusted according to the outside weather conditions, to ensure the high comfort and energy saving throughout the year. In particular, as the outside temperature increases, the system delivery temperature decreases according to a specific "compensation curve" (fig. 12).

The maximum system delivery temperature can be set with the heating buttons (details 3 & 4 - fig. 1).

The boiler must be regulated at the time of installation by qualified personnel. Possible adjustments can in any case be made by the user to improve comfort.

Compensation curve and curve offset (Only required if external sensor is installed)

Press the **mode** button (detail 10 - fig. 1) once to display the actual compensation curve value (fig. 12) which can be modified with the DHW buttons (details 1 and 2 - fig. 1).

Adjust the required curve from 1 to 10 according to the characteristic (fig. 14).

By setting the curve to 0, sliding temperature adjustment is disabled.

It is recommended that a start point of 20 to 30°C and a flow temperature of 85°C is suitable for the UK (Curve 9 or 10).

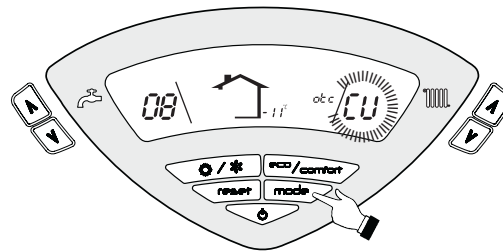

fig. 12 - Compensation curve

Press the heating buttons (details 3 and 4 - fig. 1) to access parallel curve offset (fig. 13), modifiable with the DHW buttons (details 1 and 2 - fig. 1).

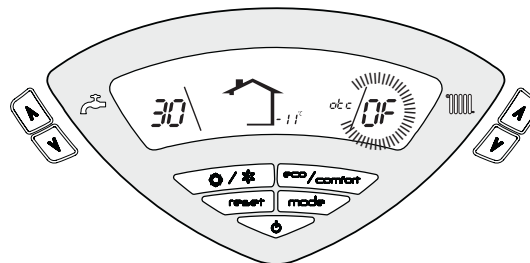

fig. 13 - Parallel curve offset

Press the **mode** button (detail 10 - fig. 1) again to exit the parallel curve adjustment mode.

If the room temperature is lower than the required value, it is advisable to set a higher order curve and vice versa. Proceed by increasing or decreasing in steps of one and check the result in the room (fig. 15).

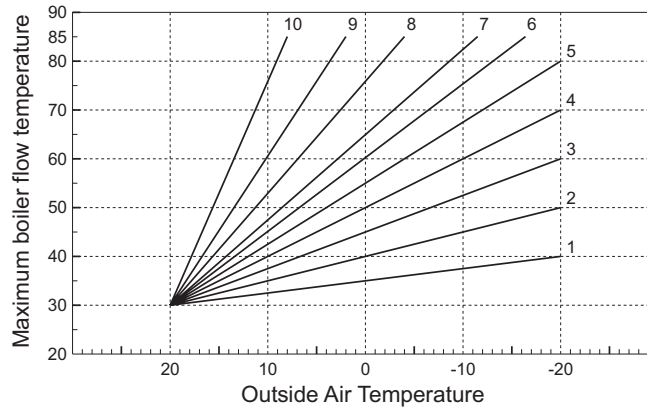

fig. 14 - Compensation curves

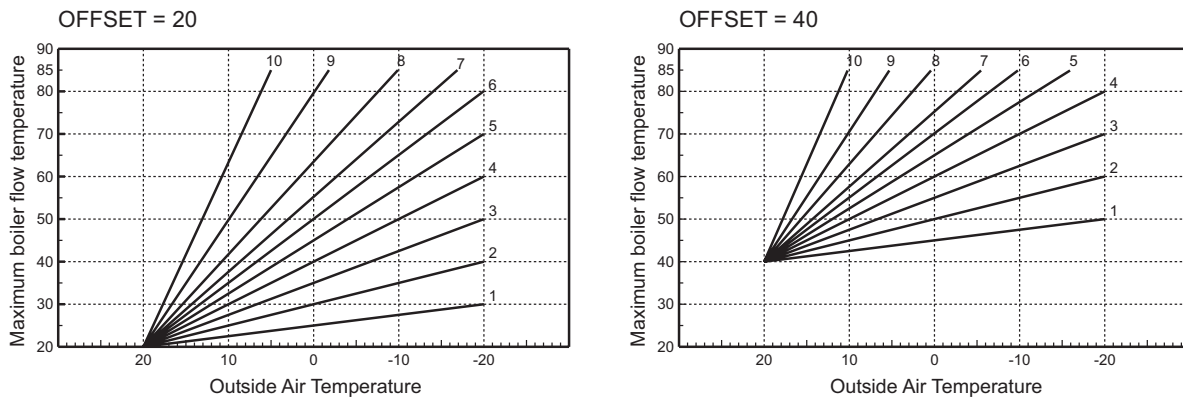

fig. 15 - Example of compensation parallel curve offset

Water system pressure adjustment

The filling pressure with system cold, read on the boiler water gauge, must be approx. 1.0 bar. If the system pressure falls to values below minimum, the boiler PCB will display fault F37 (fig. 16).

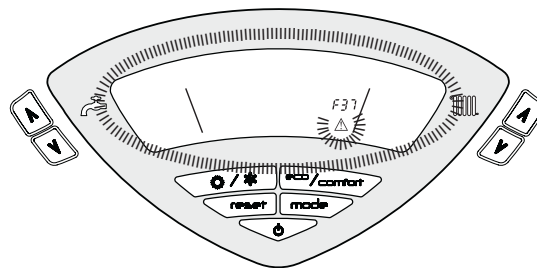

fig. 16 - Low system pressure fault

Once the system pressure is restored, the boiler will activate the 120-second air venting cycle indicated on the display by FH.

2. Installation

2.1 General Instructions



This unit must only be used for its intended purpose. This unit is designed to heat water to a temperature below boiling point and must be connected to a heating system and/or a water supply system for domestic use, compatible with its performance, characteristics and heating capacity. Any other use is deemed improper.

THE BOILER MUST ONLY BE INSTALLED BY QUALIFIED PERSONNEL, IN COMPLIANCE WITH ALL THE INSTRUCTIONS GIVEN IN THIS TECHNICAL MANUAL, THE PROVISIONS OF CURRENT LAW, THE REQUIREMENTS OF THE TECHNICAL STANDARDS (BS) AND ANY LOCAL REGULATIONS AND THE RULES OF PROPER WORKMANSHIP.

Incorrect installation can cause damage or injury for which the manufacturer cannot be deemed responsible.

The unit must be installed in compliance with these instructions and the following standards applicable in Great Britain.

Gas Safety Regulations (Installations & Use).

Local Building Regulations.

The Building Regulations (Part L).

The Buildings Standards (Scotland - Consolidated) Regulations).British Standards Codes of Practice (BSI):

B.S.	5440	Part 1	Flues
B.S.	5440	Part 2	Air flow and ventilation
B.S.	5449	Forced circulation hot water production systems
B.S.	6798	Installation of gas-fired boilers for hot water
B.S.	6891	Gas systems
B.S.	7671	IEE wiring system standards
B.S.	4814	Specifications for expansion tanks
B.S.	5482	LPG systems
B.S.	7593	Water treatment in central heating systems for DHW production
B.S.	5546	Installation of systems for DHW production

Model Water By-Laws (Great Britain)

B.S.	5955-8	Installation of plastic pipes
-------------	--------	-------	-------------------------------

For Northern Ireland the relevant laws in force must be observed.

Safe handling of materials

Pay attention when handling the boiler insulation panels because the material they are made of could irritate the skin. No part of the boiler contains asbestos, mercury or CFC's.

Advice for transport and handling

For lifting and transport always take suitable safety precautions: keep your back straight, bend knees, do not turn your body, move feet, avoid bending forward or sideways and keep the load as close as possible to your body.

If possible, use a trolley or other suitable means to carry the boiler.

Grip the boiler firmly and, before lifting it, try and find the point where the load is concentrated in order to establish the centre of gravity and suitably reposition yourself. Ideally seek assistance in lifting the boiler.

2.2 Place of installation

The combustion circuit is sealed with respect to the place of installation and therefore the unit can be installed in any room. However, the place of installation must be sufficiently ventilated to prevent the creation of dangerous conditions in case of even slight gas leaks. This safety regulation is provided for by EEC Directive no. 90/396 for all gas units, including those with a sealed chamber.

The unit is suitable for operation in a partially protected place in conformity with EN 297 pr A6, with minimum temperature -5°C . It is advisable to install the boiler under the slope of a roof, inside a balcony or in a sheltered recess.

In any case, the place of installation must be free of dust, flammable materials or objects or corrosive gases.

The boiler is arranged for wall mounting and comes standard with a hanging bracket. A paper template for marking the drilling points on the wall is provided in the box. The wall fixing must ensure stable and effective support for the generator.



If the unit is enclosed in a cabinet or mounted alongside, a space must be provided for removing the casing and for normal maintenance operations. The minimum measurements to be respected are given in fig. 17.

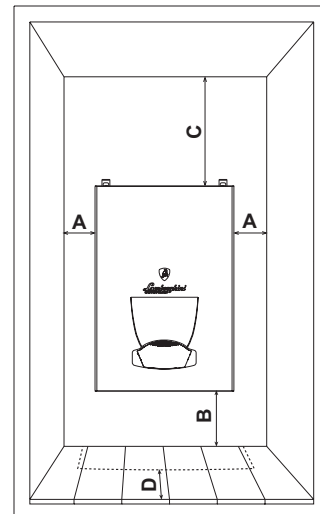

fig. 17 - Minimum distances around the boiler

- A Min. 1 cm
- B Min. 15 cm
- C Min. 30 cm
- D Min. 32 cm (via an openable panel)

2.3 Plumbing connections

Important

The heating capacity of the boiler must be previously established by calculating the building's heat requirement according to the current regulations. To ensure proper operation and long boiler life, the plumbing system must be adequately sized and complete with all the necessary accessories, including a room thermostat, a thermostatic radiator valve (TRV), etc. The system flow and return pipes must have a diameter of at least 22 mm for the first 3 m of length from the unit.

If the system delivery and return pipes follow a path where air pockets could form in certain places, it is advisable to install vent valves at these points. Also, install type "A" drain cocks at the lowest points in the system to allow complete emptying.

The temperature drop between the delivery manifold and the return to the boiler should not exceed 20°C .

A flow rate of at least 6 litres/min through the heat exchanger is required. An automatic bypass installed in the boiler guarantees maintaining of the required flow rate.



Do not use the water system pipes to earth electrical appliances.

Before installation, carefully wash all the heating system pipes to remove any residuals or impurities that could affect proper operation of the unit (as required by BS 7593 Building regs Doc L).

Carry out the connections to the unit as indicated in fig. 36.



The safety valve discharge must be connected to a 15 mm diameter copper pipe descending from the boiler to run off system water in case of overpressure in the heating circuit. Otherwise, if the discharge valve cuts in and floods the room, the boiler manufacturer cannot be held liable. The discharge must be run to the outside of the building to prevent the risk of damage or injury caused by discharged hot water in case of overpressure in the system.

Connections to the boiler are to be made in such a way as to ensure that its internal pipes and fittings are free of stress. If a non-return valve is installed also on the DHW circuit (if provided for), it is necessary to install a safety valve between the boiler and circuit (with non-return valve at least 3 metres from the boiler) or an expansion tank for domestic use.

Shutoff valve kit

The shutoff valves supplied (see fig. 18) must be installed between the boiler and heating system to allow the boiler to be isolated from the system if necessary.

For installation, follow the instructions contained in the kit.

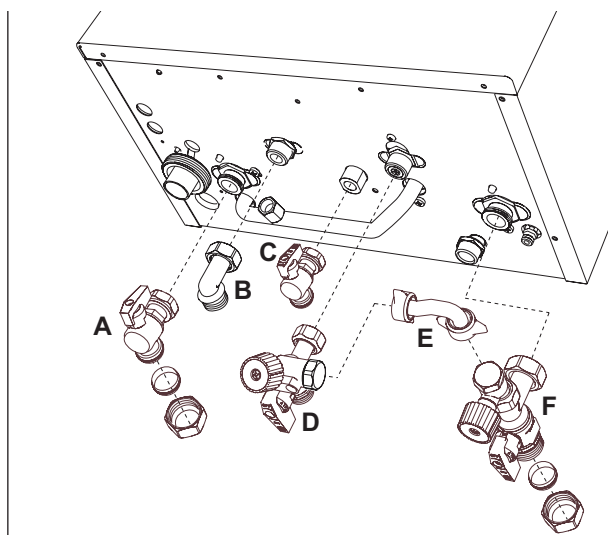

- A Delivery cock 3/4" (Red)
- B Domestic hot water outlet connection
- C Gas cock 1/2" (yellow)
- D Cold water inlet connection - System filling
- E Removable connection for system filling
- F System return cock 3/4" - System filling

fig. 18 - Shutoff valve kit

Replenishing water

It is necessary to provide for replenishing of the water lost by the sealed system. Refer to standard BS6798 for the methods of filling and replenishing water in sealed systems. There must not be a direct connection between the central heating system of the boiler and the water mains. For the use of water coming from the water mains and direct pressurisation of the system, refer to the local water management by-laws. This connection, if provided for, must be interrupted after use.

The valve installed in the boiler shell is provided with a filling connector.

Reference is made to the provisions contained in the water management by-laws.

Filling system

The boiler is provided with a special filling system. To fill the system, remove the plugs "G" and install the removable connection tube "E". Fill the system by turning both knobs "L" until the pressure gauge reads a pressure of 1 ÷ 1.5 bar. Close the knobs "L" and remove the connection tube "E".

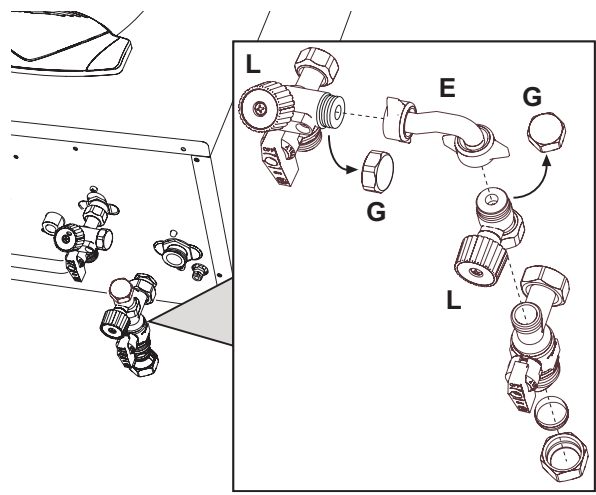





fig. 19 - Filling system

Water treatment

If treatment of the water is necessary, Ferroli recommends the exclusive use of specific products such as Fernox or Sentinel to be applied in compliance with the producer's instructions. For more information, please contact:

Fernox Manufacturing Co. LTD.
Cookson Electronics, Forsyth Road
Sheerwater, Woking, Surrey, GU21 5RZ
Tel.: 0870 8700362

Sentinel Performance Solutions Ltd
The Heath Business & Technical Park
Runcorn, Cheshire WA7 4QX
Tel.: 0151 424 5351

-  If the boiler is installed in an existing system, it is necessary to remove any unsuitable additives by thoroughly cleaning the system. Cleaning of all the systems must be carried out in compliance with the provisions of Standard B.S. 7593.
-  In areas characterised by the presence of hard water, treatment may be necessary to prevent the formation of encrustations in the boiler.
-  Make sure to use the water treatment product in the correct concentration, in compliance with the producer's instructions.

2.4 Gas connection



Before making the connection, ensure that the unit is arranged for operation with the type of fuel available and carefully clean all the pipes of the gas system to remove any residues that could affect good functioning of the boiler.

The gas must be connected to the relative connector (see fig. 36) in conformity with current standards, with rigid metal pipes or with continuous flexible s/steel wall tubing, placing a gas cock between the system and the boiler. Make sure that all the gas connections are tight. The capacity of the gas meter must be sufficient for the simultaneous use of all equipment connected to it. The diameter of the gas pipe leaving the boiler does not determine the diameter of the pipe between the unit and the meter; it must be chosen according to its length and loss of head, in conformity with current standards.



Do not use the gas pipes to earth electrical appliances.

2.5 Electrical connections

The unit must be installed in conformity with current national and local regulations.

Connection to the electrical grid



The unit's electrical safety is only guaranteed when correctly connected to an efficient earthing system executed according to current safety standards. Have the efficiency and suitability of the earthing system checked by professionally qualified personnel. The manufacturer is not responsible for any damage caused by failure to earth the system. Also make sure that the electrical system is adequate for the maximum power absorbed by the unit, as specified on the boiler dataplate.

The boiler is prewired and provided with a Y-cable and plug for connection to the electricity line. The connections to the grid must be made with a permanent connection and equipped with a bipolar switch whose contacts have a minimum opening of at least 3 mm, interposing fuses of max. 3A between the boiler and the line. It is important to respect the polarities (LINE: brown wire / NEUTRAL: blue wire / EARTH: yellow-green wire) in making connections to the electrical line. During installation or when changing the power cable, the earth wire must be left 2 cm longer than the others.



The user must never change the unit's power cable. If the cable gets damaged, switch off the unit and have it changed solely by professionally qualified personnel. If changing the electric power cable, use solely "HAR H05 VV-F" 3x0.75 mm² cable with a maximum outside diameter of 8 mm.

Accessing electrical terminal block

The electrical connections terminal block can be accessed after removing the casing. The layout of the terminals for the various connections is given in the wiring diagram in fig. 41

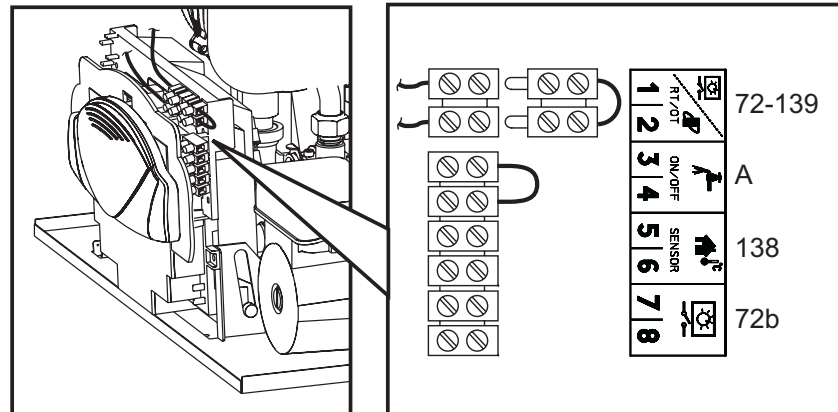

fig. 20 - Electrical terminal block

Room thermostat (optional)



CAUTION: THE ROOM THERMOSTAT MUST HAVE VOLTAGE FREE SWITCH CONTACTS.

CONNECTING 230V TO THE SWITCH TERMINALS OF THE BOILER (1-2) or (7-8) WILL IRREPARABLY DAMAGE THE BOILER PCB.

When connecting either a room thermostat or remote timer control, remove the jumper on the terminal block (1-2) and connect the volt free switch connections either across (1-2) or (7-8). If a remote timer control and room thermostat are required then these must be connected in series.

2.6 Flue system

This unit is a "C type" with **sealed chamber** and forced draught, with air inlet and flue exhaust to be connected to one of the following flue systems. Before installation, with the aid of the tables and calculation methods given, check that the pipes of the fume system do not exceed the maximum permissible lengths. The current standards and local regulations must be observed.



Only a Ferrolì flue system (with respective accessories) must be used with this unit, as required by BS 5440 and CE standards.

Connection with coaxial pipes

Standard connection with coaxial pipes (cod. 041049G0)

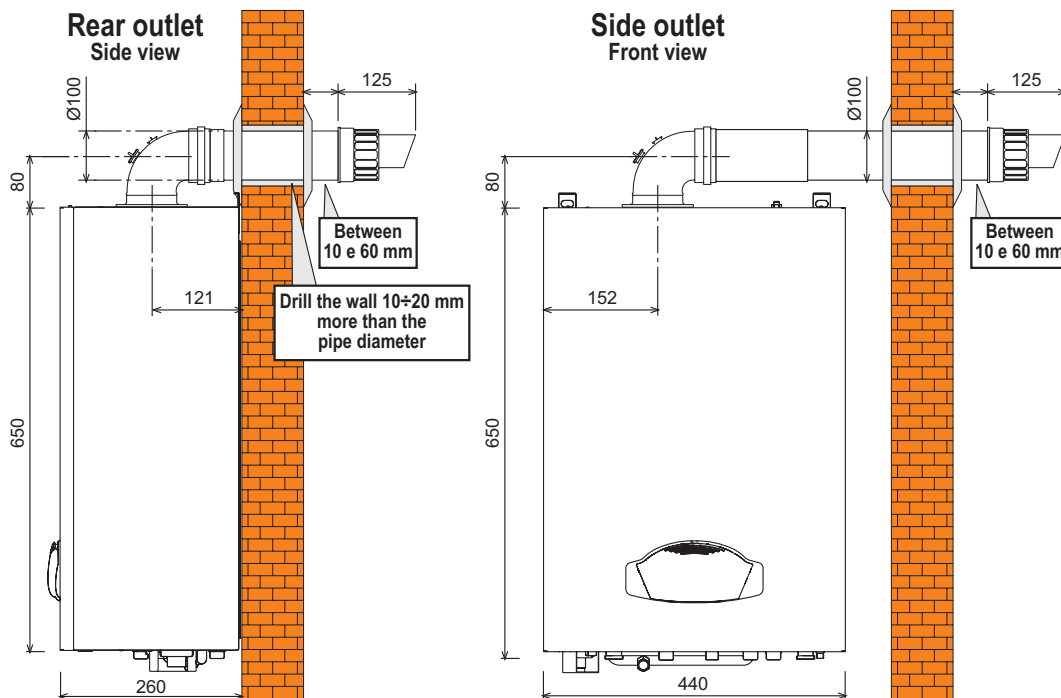

fig. 21 - Standard connection

Horizontal flue installation

1. Define the position for installing the unit.
2. If using standard flue (041049G0) this must be installed level. For extended horizontal flue lengths over 1m a fall of 3 mm per metre of the flue exhaust should be incorporated back to the boiler.
3. Make a hole of diameter 10 - 20 mm greater than the nominal diameter of the concentric pipe used.
4. If necessary, cut the terminal length to size, ensuring that the external pipe protrudes from the wall by between 10 and 60 mm. Remove the cutting burrs.
5. Connect flue to the boiler, positioning the seals correctly. Seal the flue into the wall with silicone or sand + cement and cover with wall seals provided.

Flue seals should be lubricated with a silicone type grease to prevent damage (grease not supplied).

Other coaxial connections

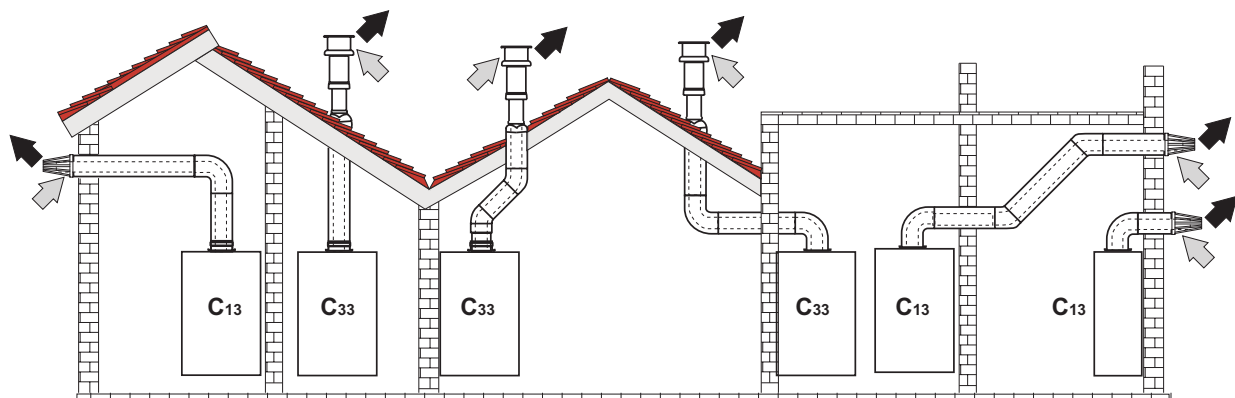

fig. 22 - Examples of connection with coaxial pipes (⇨ = Air / ⇨ = Fumes)

For coaxial connection, fit the unit with one of the following starting accessories. For the wall hole dimensions, refer to sec. 4.1 Dimensions and connections.

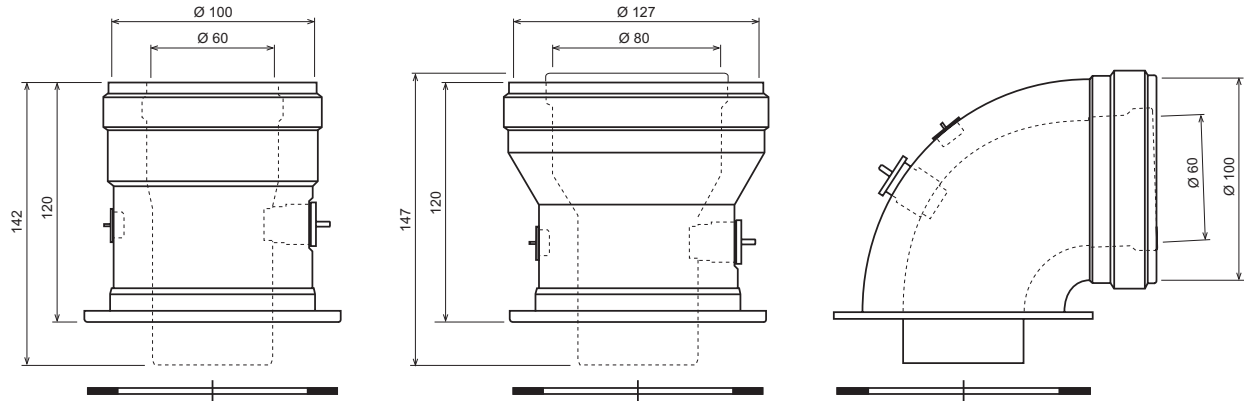

fig. 23 - Starting accessory for coaxial ducts

Before proceeding with installation, check with table 1 that the maximum permissible length is not exceeded, bearing in mind that every coaxial bend gives rise to the reduction indicated in the table. For example, a Ø 60/100 duct comprising a 90° bend + 1 horizontal metre has a total equivalent length of 2 metres.

Table 1 - Max. length coaxial ducts

	Coaxial 60/100	Coaxial 80/125
Max permissible (horizontal) equivalent flue length	5 m	15 m
Max permissible (vertical) equivalent flue length	6 m	16 m
Reduction factor 90° bend	1 m	0.5 m
Reduction factor 45° bend	0.5 m	0.25 m

Connection with separate pipes

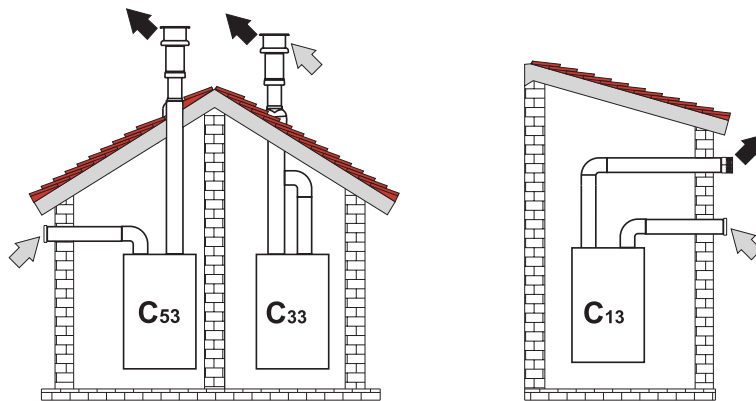

fig. 24 - Examples of connection with separate pipes (⇨ = Air / ⇨ = Fumes)

For the connection of separate ducts, fit the unit with the following starting accessory:

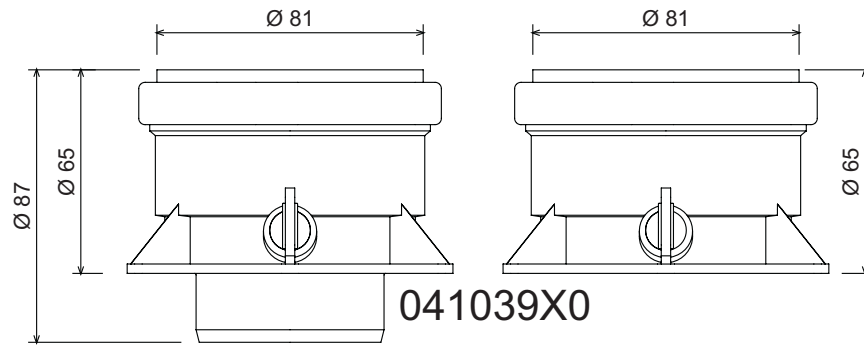

fig. 25 - Starting accessory for separate ducts

Before proceeding with installation make sure the maximum permissible length has not been exceeded, by means of a simple calculation:

1. Completely establish the layout of the system of split flues, including accessories and outlet terminals.
2. Consult the table 3 and identify the losses in m_{eq} (equivalent metres) of every component, according to the installation position.
3. Check that the sum total of losses is less than or equal to the maximum permissible length in table 2.

Table. 2 - Max. length separate ducts

Max. permissible length	Separate ducts	
	EXTREMA 30 C	EXTREMA 38 C
	80 m_{eq}	60 m_{eq}

Table. 3 - Accessories

			Losses in m_{eq}		
			Air inlet	Fume exhaust	
				Vertical	Horizontal
Ø 80	PIPE	1 m M/F			
	BEND	45° M/F			
		90° M/F			
	PIPE SECTION	with test point			
	TERMINAL	air, wall			
		fumes, wall with antiwind			
	FLUE	Split air/fumes 80/80			

Position of terminals

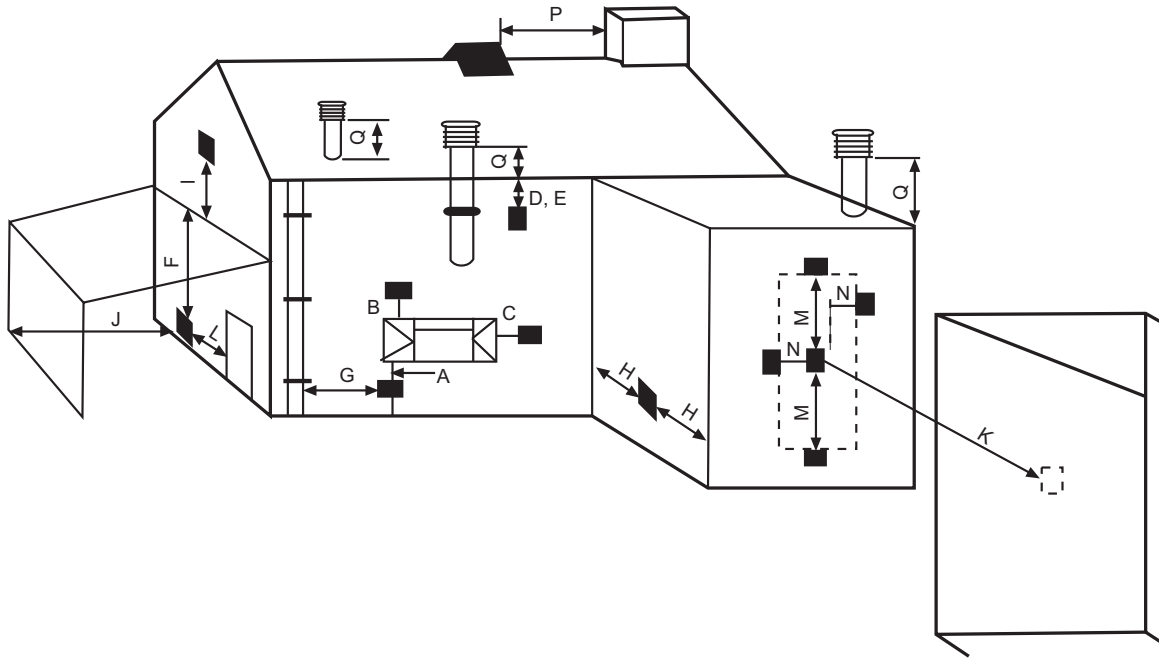

fig. 26

Minimum dimensions of fume exhaust terminals

Minimum dimensions of fume exhaust terminals		
A	Directly under an opening, air inlet, openable window, etc.	300 mm
B	Above an opening, air inlet, openable window, etc.	300 mm
C	Horizontally to an opening, air inlet, openable window, etc.	300 mm
D	Under gutters, drain pipes	75 mm
E	Under cornices or under eaves	200 mm
F	Under balconies or garages	200 mm
G	From a drain pipe or a vertical drain pipe	150 mm
H	From an internal or external corner	100 mm
I	Above ground level, a roof or balcony	300 mm
J	From a surface facing the terminal	600 mm
K	From a terminal facing the terminal	1200 mm
L	From a garage opening (e.g. door, window) with access to the home	1200 mm
M	Vertically from a terminal on the same wall	1500 mm
N	Horizontally from a terminal on the same wall	300 mm
O	From the wall on which the terminal is fitted	N/A
P	From a vertical structure on the roof	150 mm
Q	Above the intersection with the roof	300 mm
NOTES	<ul style="list-style-type: none"> • N/A = Not applicable • Also, the terminal must be at least 150 mm (in case of forced intake) from an opening made in the structure of the building to house a fitted element such as a window frame. • Positions of condensate drain terminals: if the fume exhaust is provided for at a low level, the potential effect of the flue gas cloud must be considered. Special flue gas management kits are available by request. • The flue gas cloud must not be directed towards: <ul style="list-style-type: none"> - A frequented approach - A window or door - An adjacent property 	

Connection to multiple flues or single flues with natural draught

To connect the **EXTREMA** boiler to a multiple flue or a single flue with natural draught, the flue or chimney must be expressly designed by professionally qualified technical personnel in conformity with the current standards and regulations.

In particular, flues and chimneys must:

- Be sized according to the method of calculation given in the standard.
- Be tight with respect to the products of combustion, resistant to the fumes and heat and impermeable to condensate.
- Have a circular or square cross-section (some hydraulically equivalent sections are permissible), with a vertical progression and with no constrictions.
- Have the ducts conveying the hot fumes at a suitable distance or separately from combustible materials.
- Be connected to just one unit per floor, for not more than 6 units (8 if there is a compensation duct or opening).
- Have no mechanical suction devices in the main ducts.
- Be at low pressure, all along their length, in conditions of stationary operation.
- Have at their base a collection chamber for solid materials or condensate, of at least 0.5 m, equipped with an airtight metal door.

2.7 Condensate drain connection

Installation

The boiler has an internal condensate drain trap.

For installation, remove the protection bracket **A** which will not be used.

Fit the inspection union **B** and the flexible tube **C**, pressing it in for approx. 3 cm.

Fill the trap with approx. 0.5 l. of water **D** and connect the flexible tube to the drainage system or a condensate collection pit **E**.

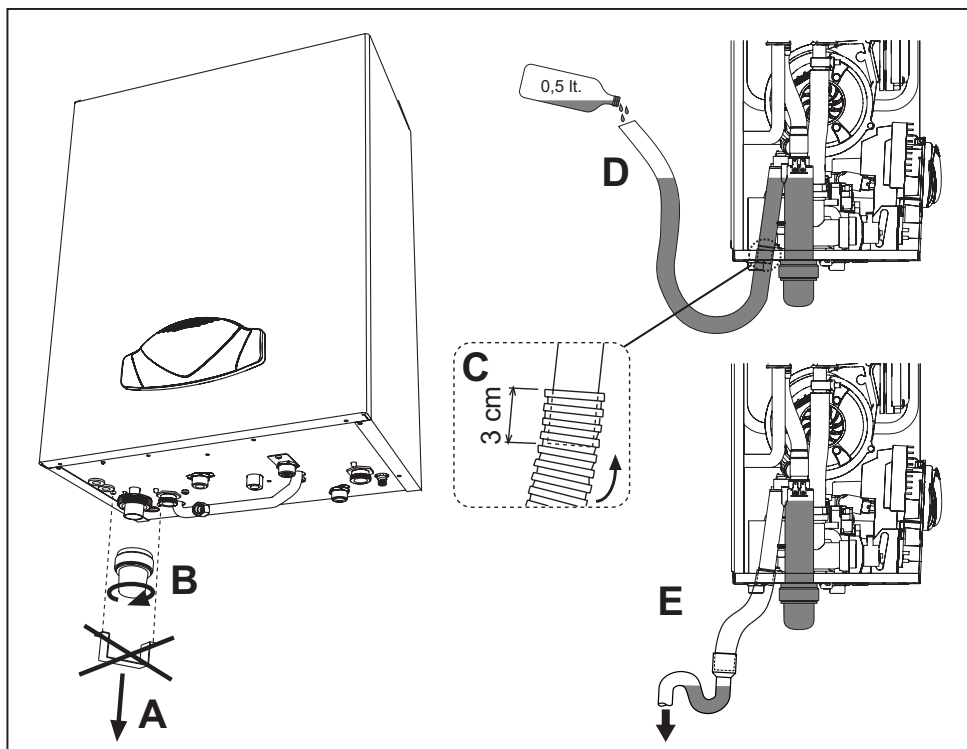

fig. 27

Condensate drain

If possible, the condensate should be conveyed inside an underground drainage system or pipe. For that purpose, use a pipe of at least 22 mm diameter and a trap with flexible connection preinstalled in the unit to facilitate connection of the condensate drain pipe.

The pipe must be in glue-joined plastic and not in copper, since the condensate has a pH of 4 (slightly acid).

If the condensate drain pipe cannot be ended on the inside, it is advisable to run it outside as shown in the following figure.

The pipe sections going to the outside are exposed to the risk of freezing in particularly extreme weather conditions. To prevent this from occurring, it is advisable to reduce the length of the condensate drain pipes and run them on the inside, as much as possible, before going to the outside. It may also be necessary to insulate the condensate pipe or apply a trace heating device to prevent freezing of the condensate.

The pipes outside the building must be in glue-joined plastic with increased diameter of up to 32 or 40 mm with a maximum run of 3m for connection to a condensate collection pit or external drain.

If using a condensate collection pit, it must be as indicated in the figure below, or use a specific system (such as Mc Alpine SOAK1GR) available from the majority of suppliers of products and accessories for plumbing or heating systems.

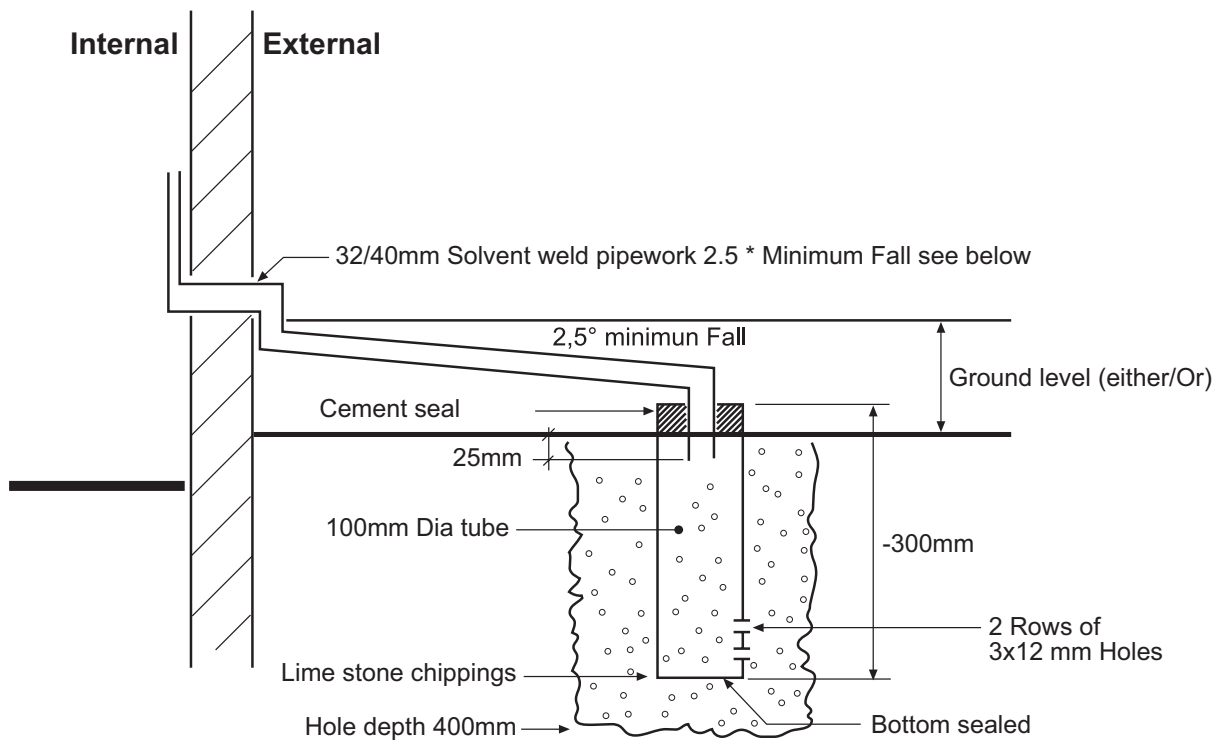

fig. 28 - Condensate drain

3. Service and maintenance

All adjustment, conversion, startup and maintenance operations described below must only be carried out by Qualified Personnel (meeting the professional technical requirements prescribed by current regulations).

LAMBORGHINI declines any liability for damage and/or injury caused by unqualified and unauthorised persons tampering with the unit.

3.1 Adjustments

Gas conversion

The unit can operate on Natural Gas or LPG and is factory-set for use with one of these two gases, as clearly shown on the packing and on the dataplate. Whenever a different gas to that for which the unit is arranged has to be used, a conversion kit will be required, proceeding as follows:

1. Remove the casing.
2. Follow the sequence of fig. 29 to access the gas nozzle **6**.
3. Replace the gas nozzle (**6**) inserted in the mixer, with that contained in the conversion kit.
4. Reassemble and check the tightness of the connection.
5. Apply the label, contained in the conversion kit, near the dataplate.
6. Refit the casing.
7. Modify the parameter for the type of gas:
 - put the boiler in standby mode
 - press the DHW buttons (details 1 and 2 - fig. 1) for 10 seconds: the display shows "P01" flashing.
 - Press the DHW buttons fig. 1(details 1 and 2 -) to set parameter **00** (for natural gas) or **01** (for LPG).
 - Press the heating + button (detail 4 - fig. 1). The display shows "P02" flashing.
 - Press the DHW buttons (details 1 and 2 - fig. 1) to set parameter **200** (for natural gas) or **190** (for LPG).
 - Press the heating + button (detail 4 - fig. 1). The display shows "P03" flashing.
 - Press the DHW buttons (details 1 and 2 fig. 1) to set parameter **170** (for natural gas) or **165** (for LPG).
 - press the DHW buttons (details 1 and 2 - fig. 1) for 10 seconds.
 - the boiler will return to standby mode
8. Check the working pressure.
9. Using a combustion analyser connected to the boiler flue outlet, check that the CO₂ content in the flue exhaust, with the boiler operating at max. and min. output, matches that given in the technical data table for the corresponding type of gas.

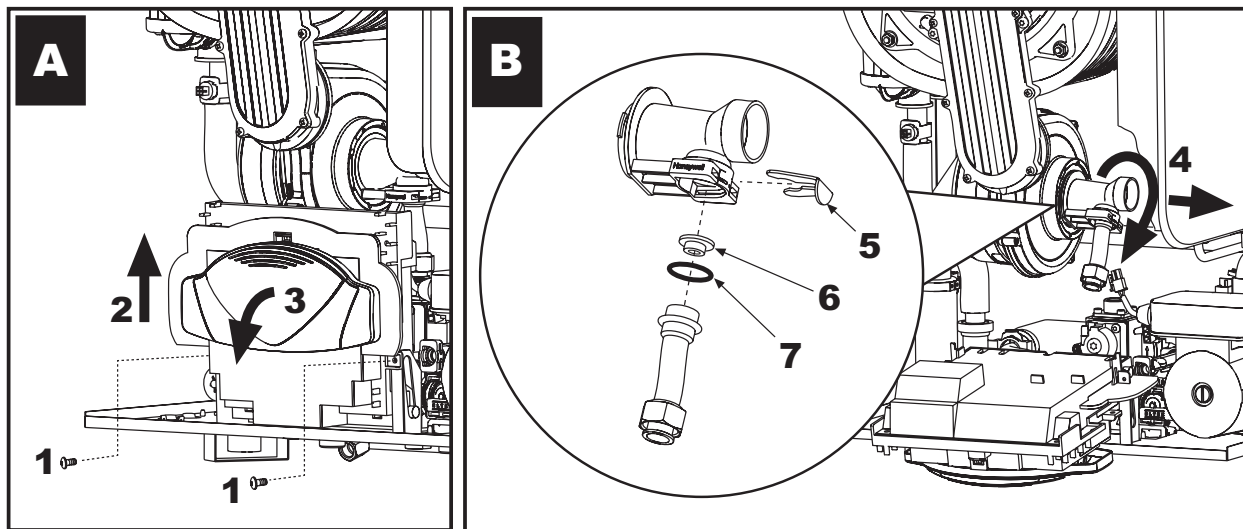

fig. 29 - Changing the gas nozzle

3.2 Start-up



Checks to be made at first lighting, and after all maintenance operations that involved disconnection from the systems or an operation on safety devices or parts of the boiler:

Before lighting the boiler

- Open any on-off valves between the boiler and the systems.
- Check the tightness of the gas system, proceeding with caution and using a soap and water solution to detect any leaks in connections.
- Check correct prefilling of the expansion tank (ref. sec. 4.4 Technical data table).
- Fill the water system and make sure all air contained in the boiler and the system has been vented, by opening the air vent valve on the boiler and any vent valves on the system.
- Fill the condensate trap and check correct connection of the condensate elimination system.
- Make sure there are no water leaks in the system, DHW circuits, connections or boiler.
- Check correct connection of the electrical system and efficiency of the earthing system
- Make sure the gas pressure value for heating is that required.
- Make sure there are no flammable liquids or materials in the immediate vicinity of the boiler.

Checks during operation

- Turn the unit on as described in sec. 1.3 Lighting and turning off.
- Make sure the fuel circuit and water systems are tight.
- Check the efficiency of the flue exhaust and air ducts while the boiler is working.
- Check the correct tightness and functionality of the condensate elimination system and trap.
- Make sure the water is circulating properly between the boiler and the systems.
- Make sure the gas valve modulates correctly in the heating and domestic hot water production phases.
- Check proper boiler lighting by doing several tests, turning it on and off with the room thermostat or remote control.
- Using a combustion analyser connected to the boiler fume outlet, check that the CO₂ content in the fumes, with the boiler operating at max. and min. output, corresponds to that given in the technical data table for the corresponding type of gas.
(Because the combustion for this appliance has been checked, adjusted and preset at the factory, it is only necessary to undertake a further combustion check if there are operating performance difficulties or the boiler has been converted or if essential components have been replaced).
- Make sure the gas rate indicated on the meter matches that given in the technical data table on sec. 4.4 Technical data table.
- Check the correct programming of the parameters and carry out any necessary customization (compensation curve, power, temperatures, etc.).
(As the parameters for each boiler are factory set, there is no requirement to recheck parameters at the time of commissioning unless a gas conversion has been undertaken.)

3.3 Commissioning instructions

General

PLEASE NOTE: The combustion for this appliance has been checked, adjusted and preset at the factory for operation on the gas type defined on the appliance data plate.

Having checked:

- That the boiler has been installed in accordance with these instructions,
- The integrity of the flue system and the flue seals.
- The integrity of the boiler combustion circuit and the relevant seals.

Test mode

Proceed to put the boiler into operation as follows:

1. To operate the boiler in test mode, press the CH keys together for 5 seconds (see fig. 30)
2. The boiler lights at percentage ignition (40% dependant on model)

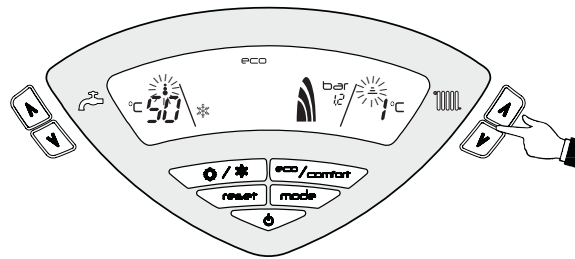

fig. 30 - Test Mode

3. The heating power will be displayed 100% - denoted by flashing '1' then '00' continuously on the LCD display (see fig. 31)
4. The flame symbol will be displayed once the boiler has lit.

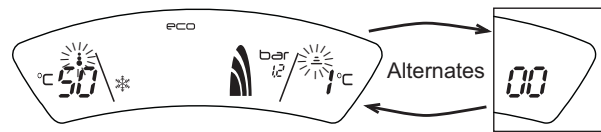

fig. 31

5. N.B. The ECO symbol will only be displayed if boiler is in the ECO mode.
6. Use the **CH keys** to give the required output.
7. To exit the test mode, press the **CH keys** together for 5 seconds, or leave the boiler to automatically switch off after 15 minutes or stopping DHW drawing.

Check the operational (working) gas inlet pressure

Set up the boiler to operate at maximum rate as described in sec. Test mode of cap. 3.3.

With the boiler operating in the maximum rate condition check that the operational (working) gas pressure at the inlet gas pressure test point (see fig. 32) complies with the requirements of cap. 4.4.

Ensure that this inlet pressure can be obtained with all other gas appliances in the property working.

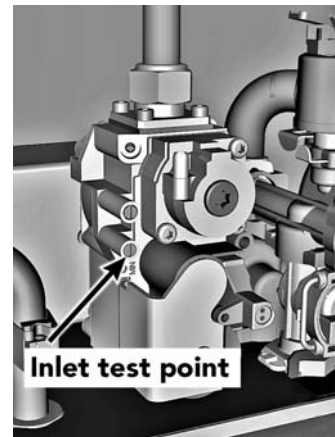

fig. 32

Measure the gas rate

Measure the gas rate and check against following table:

GAS RATES (NATURAL GAS) AFTER 10 MINUTES FROM COLD				
BOILER MODEL	Maximum rate		Minimum rate	
	m ³ /h	ft ³ /h	m ³ /h	ft ³ /h
EXTREMA 30 C	3.1	109.48	0.61	21.54
EXTREMA 38 C	3.92	138.43	0.74	26.13

3.4 Routine servicing, maintenance & repair

General

PLEASE NOTE: During routine servicing, and after any maintenance or change of part of the combustion circuit, we recommend that the following is checked:

- The integrity of the flue system and the flue seals;
- The integrity of the boiler combustion circuit and the relevant seals;
- The operational (working) gas inlet pressure at maximum rate, as described in cap. 4.4;
- The gas rate, as described in cap. 4.4;
- The combustion performance, as described in sec. Combustion check of cap. 3.4

Competence to carry out the check of combustion performance

PLEASE NOTE: BS 6798: 2009 Specification for installation and maintenance of gas-fired boilers of rated input not exceeding 70 kW net advises that:

- The person carrying out a combustion measurement should have been assessed as competent in the use of a flue gas analyser and the interpretation of the results;
- The flue gas analyser used should be one meeting the requirements of BS7927 or BS-EN50379-3 and be calibrated in accordance with the analyser manufacturers' requirements, and
- Competence can be demonstrated by satisfactory completion of the CPA1 ACS assessment, which covers the use of electronic portable combustion gas analysers in accordance with BS 7967, Parts 1 to 4.

Periodical check

To keep the unit working properly over time, it is necessary to have qualified personnel make an annual check that includes the following tests:

- The control and safety devices (gas valve, flow meter, thermostats, etc.) must function correctly.
- The fume extraction circuit must be fully efficient.
- The airtight chamber must be sealed
- The air-fume end piece and ducts must be free of obstructions and leaks
- The condensate evacuation system must be efficient with no leakage or obstructions.
- The burner and exchanger must be clean and free of scale. When cleaning, do not use chemical products or wire brushes.
- The electrode must be free of scale and properly positioned.
- The gas and water systems must be airtight.
- The water pressure in the cold water system must be about 1 bar; otherwise, bring it to that value.
- The circulation pump must not be blocked.
- The expansion tank must be filled.
- The gas flow and pressure must correspond to that given in the respective tables.

 The boiler casing, panel and aesthetic parts can be cleaned with a soft damp cloth, possibly soaked in soapy water. Do not use any abrasive detergents and solvents.

Opening the casing

To open the boiler casing (see fig. 33)

1. Undo the screws A
2. Turn the casing
3. Lift the casing



Before carrying out any operation inside the boiler, disconnect the electrical power supply and close the gas cock upstream

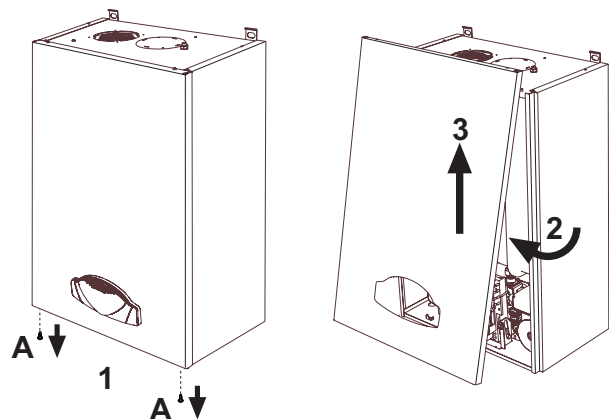

fig. 33 - Opening the casing

Combustion check

Connect the flue gas analyzer to the flue gas sampling point as shown in the fig. 34 and check combustion as described in table 4 and table 5.

1. Press the CH button for 5 seconds to place boiler into test mode
2. Wait for 10 minutes for the boiler to stabilize fully
3. Take the measurement and record
4. Take the boiler to minimum output by pressing the CH – button, allow the boiler to stabilize for a further 10 minutes.
5. Take the measurement and record.

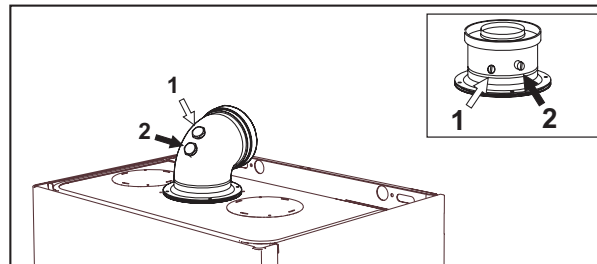

fig. 34 - Flue gas sampling Point

1 = Air - 2 = Fumes

Tabella. 4 - Maximum rate

NATURAL GAS ACCEPTABLE COMBUSTION RANGE MAXIMUM RATE AFTER 10 MINUTES FROM COLD			
Boiler Model	CO/CO ₂ RATIO	CO ₂ NG	CO ₂ LPG
EXTREMA 30 C	≤ 0.004	8,7 ÷ 9,2	10 ÷ 10,5
EXTREMA 38 C	≤ 0.004		

Tabella. 5 - Minimum rate

NATURAL GAS ACCEPTABLE COMBUSTION RANGE MINIMUM RATE AFTER 10 MINUTES FROM COLD			
Boiler Model	CO/CO ₂ RATIO	CO ₂ NG	CO ₂ LPG
EXTREMA 30 C	≤ 0.004	8,2 ÷ 8,7	9,5 ÷ 10,0
EXTREMA 38 C	≤ 0.004		

If the combustion reading is greater than the acceptable value AND the integrity of the complete flue system and combustion circuit seals have been verified and the inlet gas pressure (and gas rate) have been verified, proceed as in section sec. Setting the Air/Gas Ratio valve.

Setting the Air/Gas Ratio valve

There are two adjustments possible on the air/gas ratio valve, the throttle setting at maximum rate and the offset setting at minimum rate. If either setting is adjusted the combustion values must be rechecked at both rates.

At Maximum Rate:

1. Adjust the boiler to maximum rate in sec. Test mode of cap. 3.3
2. Wait 10 minutes to allow the boiler to stabilize.
3. Now adjust the **Throttle setting** (fig. 35 - screw **A**) until the CO₂ is at the correct **SETTING LEVEL** (see table 4), confirm that the CO/CO₂ ratio is within limits.

NOTE: ADJUST IN STEPS OF **NO MORE THAN 1/8 OF A TURN** AND WAIT 1 MINUTE AFTER EACH ADJUSTMENT TO ALLOW THE SETTING TO STABILISE.

In the event that the CO₂ setting level with an acceptable CO/CO₂ ratio cannot be obtained please contact the helpline number.

Should you require any assistance during the set up procedure call our Technical service helpline or should you require a service engineer to visit call our service centre at numbers listed on last page of this manual.

At Minimum Rate:

1. Adjust the boiler to minimum output and allow the boiler to stabilize.
2. Now adjust the **offset pressure setting** (fig. 35 - cup **B**) until the CO₂ is at the correct **SETTING LEVEL** (see table 5), confirm that the CO/CO₂ ratio is within limits.

NOTE: ADJUST IN STEPS OF **NO MORE THAN 1/8 OF A TURN** AND WAIT 1 MINUTE AFTER EACH ADJUSTMENT TO ALLOW THE SETTING TO STABILISE.

Re-check the Minimum Rate

Turn off the boiler, turn off in test mode to max for a while and then go back to min. Then go back to min. and re-check the minimum rate output ensuring the CO₂ setting level has remained unchanged and confirm that the CO/CO₂ ratio is within limits.

In the event that the CO₂ setting level with an acceptable CO/CO₂ ratio cannot be obtained please contact the helpline number.

Should you require any assistance during the set up procedure call our Technical service helpline or should you require a service engineer to visit call our service centre at numbers listed on last page of this manual.

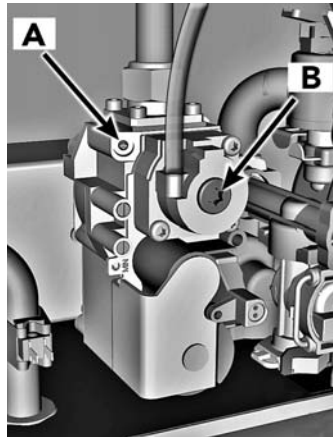

fig. 35 - Gas valve

- A Throttle
- B Offset adjustment

NOTE: In the event that an acceptable setting level cannot be obtained it will be necessary to change the Air/Gas Ratio Valve.

3.5 Troubleshooting

Diagnostics

The boiler is equipped with an advanced self-diagnosis system. In case of a boiler fault, the display will flash together with the fault symbol (detail 22 - fig. 1) indicating the fault code (detail 21 - fig. 1).

Certain faults cause permanent boiler shutdowns (marked with the letter “A”): to restore operation, press the RESET button (detail 8 - fig. 1) for 1 second or RESET on the optional remote timer control if installed; if the boiler fails to start, it is necessary to firstly eliminate the fault.

other faults (indicated with the letter “F”) cause temporary shutdowns that are automatically reset as soon as the value returns within the boiler's normal working range.

Table. 6 - List of faults

Fault code	Fault	Possible cause	Cure
A01	No burner ignition	No gas	Check the regular gas flow to the boiler and that the air has been eliminated from the pipes
		Ignition/detection electrode fault	Check the wiring of the electrode and that it is correctly positioned and free of any deposits
		Faulty gas valve	Check the gas valve and replace it if necessary
		Insufficient gas supply pressure	Check the gas supply pressure
A02	Flame present signal with burner off	Trap blocked	Check the trap and clean it if necessary
		Electrode fault	Check the ionisation electrode wiring
A03	Overtemperature protection activation	Card fault	Check the card
		Heating sensor damaged	Check the correct positioning and operation of the heating sensor
A04	Fume extraction duct safety device activation	No water circulation in the system	Check the circulating pump
		Air in the system	Vent the system
A04	Fume extraction duct safety device activation	Fault F07 generated 3 times in the last 24 hours	See fault F07

Fault code	Fault	Possible cause	Cure
A05	Fan protection activated	Fault F15 generated for 1 hour (consecutive)	See fault F15
A06	No flame after ignition stage (6 times in 4 minutes)	Ionisation electrode fault	Check the position of the ionisation electrode and replace it if necessary
		Flame unstable	Check the burner
		Gas valve Offset fault	Check the Offset adjustment at minimum power
		air/fume ducts obstructed	Remove the obstruction from the flue, fume extraction ducts and air inlet and terminals
		Trap blocked	Check the trap and clean it if necessary
F07	High fume temperature	Flue partially obstructed or insufficient	Check the efficiency of the flue, fume extraction ducts and outlet terminal
		Fume sensor position	Check the correct positioning and operation of the fume sensor
F10	Delivery sensor 1 fault	Sensor damaged	Check the wiring or replace the sensor
		Wiring shorted	
		Wiring disconnected	
F11	Return sensor fault	Sensor damaged	Check the wiring or replace the sensor
		Wiring shorted	
		Wiring disconnected	
F12	DHW sensor fault	Sensor damaged	Check the wiring or replace the sensor
		Wiring shorted	
		Wiring disconnected	
F13	Fume sensor fault	Sensor damaged	Check the wiring or replace the sensor
		Wiring shorted	
		Wiring disconnected	
F14	Delivery sensor 2 fault	Sensor damaged	Check the wiring or replace the sensor
		Wiring shorted	
		Wiring disconnected	
F15	Fan fault	No 230V power supply	Check the wiring of the 3-pin connector
		Tachometric signal interrupted	Check the wiring of the 5-pin connector
		Fan damaged	Check the fan
F20	Incorrect system water pressure	The pressure is reaching the minimum value	Check the system
			Check/set the safety valve
			Check the expansion tank
F21	Incorrect system water pressure	The pressure is reaching the maximum value	Check the system
			Check the safety valve
			Check the expansion tank
A26	System protection activation	Fault F40 generated 3 times in the last hour	See fault F40
F34	Supply voltage under 170V	Electric mains trouble	Check the electrical system
F35	Faulty mains frequency	Electric mains trouble	Check the electrical system
F37	Incorrect system water pressure	Pressure too low	Fill the system
		Sensor damaged	Check the sensor
F39	External probe fault	Probe damaged or wiring shorted	Check the wiring or replace the sensor
		Probe disconnected after activating the sliding temperature	Reconnect the external probe or disable the sliding temperature
F40	Incorrect system water pressure	Pressure too high	Check the system
			Check the safety valve
			Check the expansion tank
A41	Sensor positioning	Delivery sensor detached from pipe	Check the correct positioning and operation of the heating sensor
F42	Heating sensor fault	Sensor damaged	Replace the sensor
F47	System water pressure sensor fault	Wiring disconnected	Check the wiring



4. Technical data and characteristics

4.1 Dimensions and connections

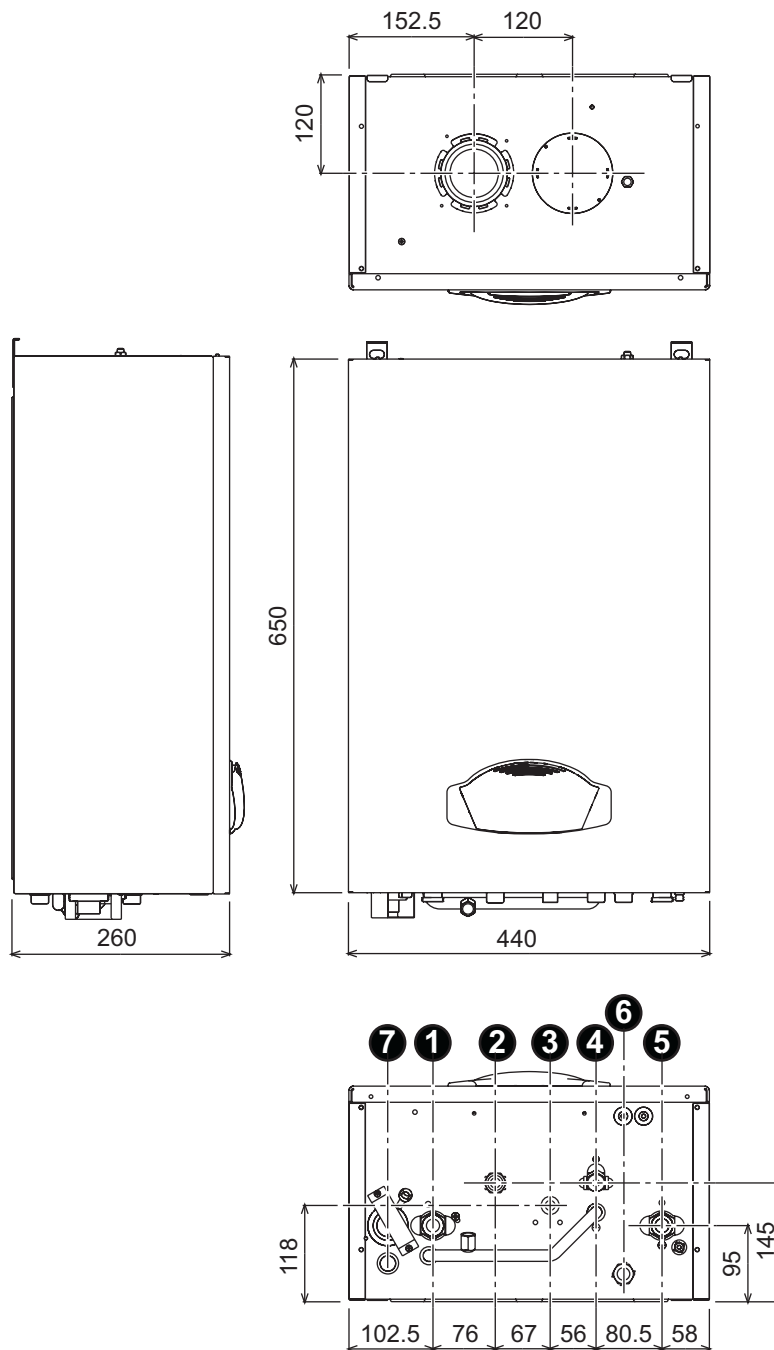

fig. 36 - Dimensions and connections

- | | |
|-------------------------------|---------------------------|
| 1 = Heating system delivery | 5 = Heating system return |
| 2 = Domestic hot water outlet | 6 = Safety valve drain |
| 3 = Gas inlet | 7 = Condensate drain |
| 4 = Cold water inlet | |

4.2 General view and main components

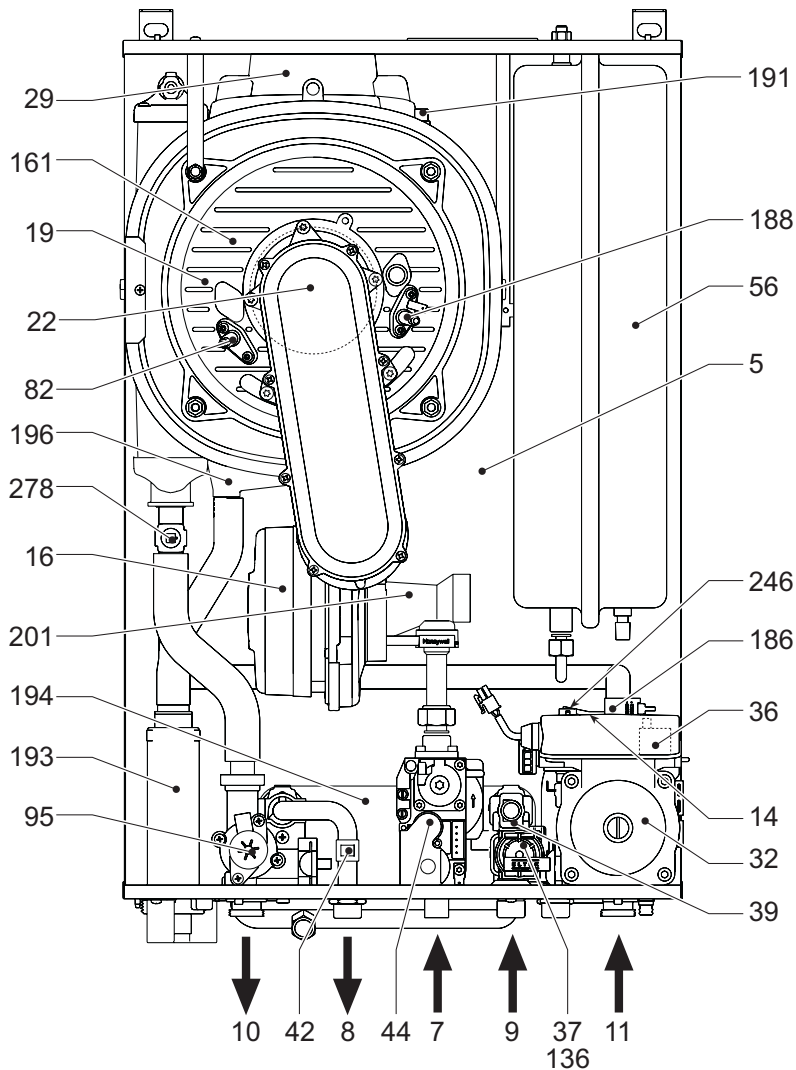

fig. 37 - General view

Key

- | | | | |
|----|---------------------------|-----|----------------------------------|
| 5 | Sealed chamber | 44 | Gas valve |
| 7 | Gas inlet | 56 | Expansion tank |
| 8 | Domestic hot water outlet | 82 | Detection electrode |
| 9 | Cold water inlet | 95 | Diverter valve |
| 10 | System delivery | 136 | Flow meter |
| 11 | System return | 161 | Condensing heat exchanger |
| 14 | Safety valve | 186 | Return sensor |
| 16 | Fan | 188 | Ignition electrode |
| 19 | Combustion chamber | 191 | Fume temperature sensor |
| 22 | Main burner | 193 | Trap |
| 29 | Fume outlet manifold | 194 | DHW exchanger |
| 32 | Heating circulating pump | 196 | Condensate tray |
| 36 | Automatic air vent | 201 | Mixing chamber |
| 37 | Cold water inlet filter | 246 | Pressure transducer |
| 39 | Flow regulator | 278 | Double sensor (Safety + Heating) |
| 42 | DHW temperature probe | | |

4.3 Water circuit

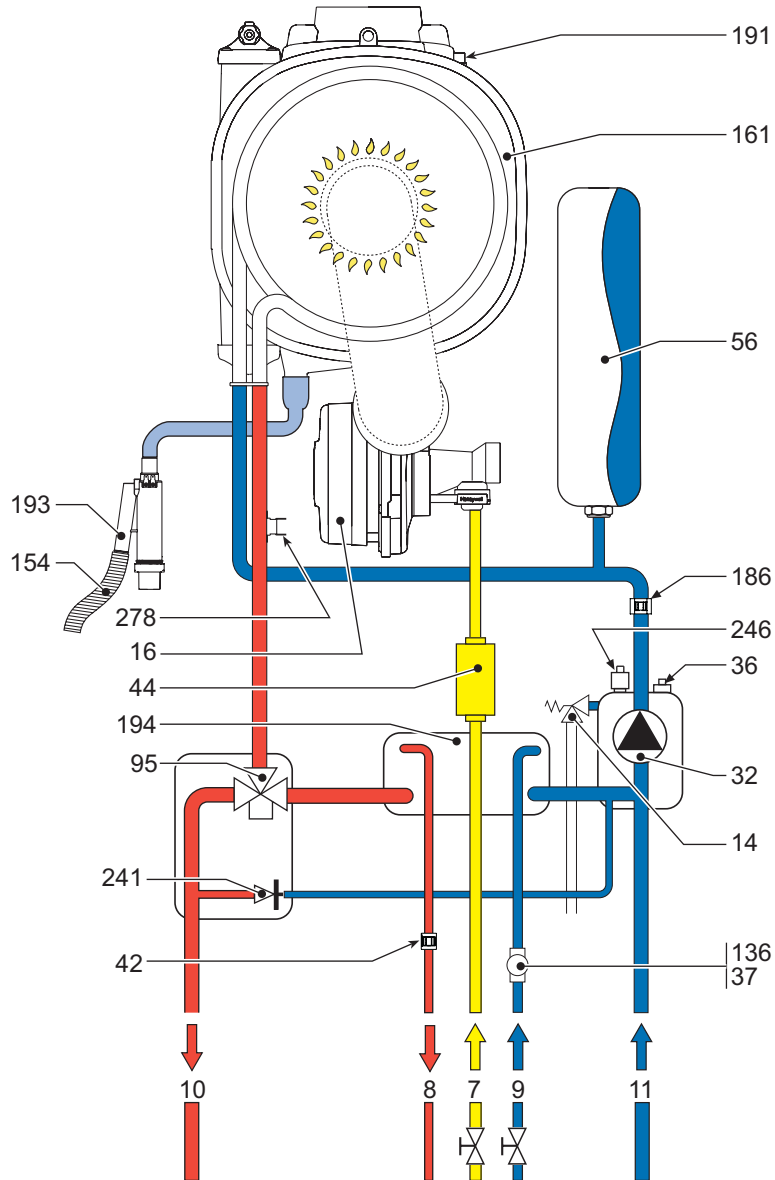

fig. 38 - Water circuit

Key

- | | | | |
|----|---------------------------|-----|----------------------------------|
| 7 | Gas inlet | 56 | Expansion tank |
| 8 | Domestic hot water outlet | 95 | Diverter valve |
| 9 | Cold water inlet | 136 | Flow meter |
| 10 | System delivery | 154 | Condensate outlet pipe |
| 11 | System return | 161 | Condensing heat exchanger |
| 14 | Safety valve | 186 | Return sensor |
| 16 | Fan | 191 | Fume temperature sensor |
| 32 | Heating circulating pump | 193 | Trap |
| 36 | Automatic air vent | 194 | DHW exchanger |
| 37 | Cold water inlet filter | 241 | Automatic bypass |
| 42 | DHW temperature probe | 246 | Pressure transducer |
| 44 | Gas valve | 278 | Double sensor (Safety + Heating) |

4.4 Technical data table

Data	Unit	EXTREMA 30 C	EXTREMA 38 C	
Max. heating capacity	kW	25.2	32.2	(Q)
Min. heating capacity	kW	5.8	7.0	(Q)
Max. Heat Output in heating (80/60°C)	kW	24.6	31.4	(P)
Min. Heat Output in heating (80/60°C)	kW	5.7	6.8	(P)
Max. Heat Output in heating (50/30°C)	kW	26.6	33.9	
Min. Heat Output in heating (50/30°C)	kW	6.2	7.5	
Max. heating capacity in hot water production	kW	29.3	37.0	
Min. heating capacity in hot water production	kW	5.8	7.0	
Max. Heat Output in hot water production	kW	29.3	37.0	
Min. Heat Output in hot water production	kW	5.7	6.8	
Gas supply pressure G20	mbar	20	20	
Maximum DHW production Dt 35°C	l/min	12.0	15.2	
Max. gas delivery G20	m ³ /h	3.1	3.92	
Min. gas delivery G20	m ³ /h	0.61	0.74	
Gas supply pressure G31	mbar	37	37	
Max. gas delivery G31	kg/h	2.29	2.9	
Min. gas delivery G31	kg/h	0.45	0.55	
Efficiency class Directive 92/42 EEC	-	★★★★		
NOx emission class	-	5	5	(NOx)
Max. working pressure in heating	bar	3	3	(PMS)
Min. working pressure in heating	bar	0.8	0.8	
Max. heating temperature	°C	95	95	(tmax)
Heating water content	litres	1.9	2.3	
Heating expansion tank capacity	litres	8	10	
Heating expansion tank prefilling pressure	bar	1	1	
Protection rating	IP	X5D	X5D	
Power supply voltage	V/Hz	230V/50Hz	230V/50Hz	
Electrical power input	W	130	150	
Electrical power input in hot water production	W	130	150	
Empty weight	kg	27.5	30	
Type of unit		C13-C23-C33-C43-C53-C63-C83-B23-B33		
PIN CE		0461BU0941		

4.5 Diagrams

Circulating pumps head/pressure loss model EXTREMA 30 C

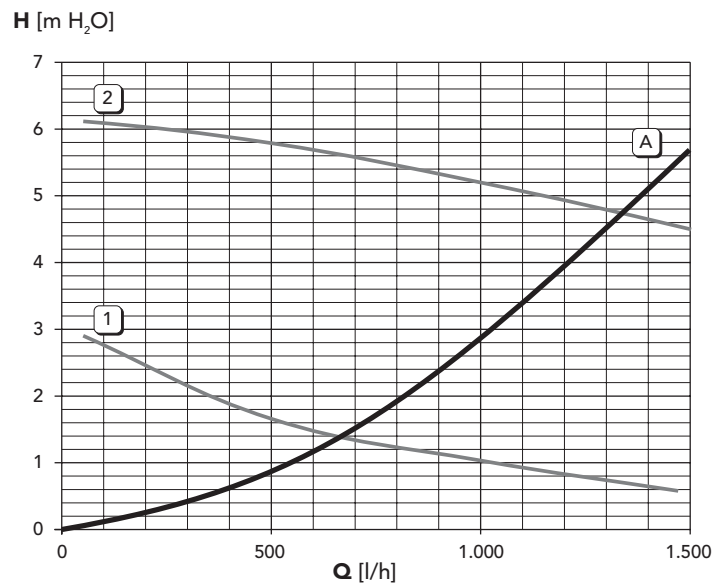

fig. 39 - Pressure loss

- A Boiler pressure losses
- 1 Circulating pump min. speed
- 2 Circulating pump max. speed

Circulating pumps head / pressure losses model EXTREMA 38 C

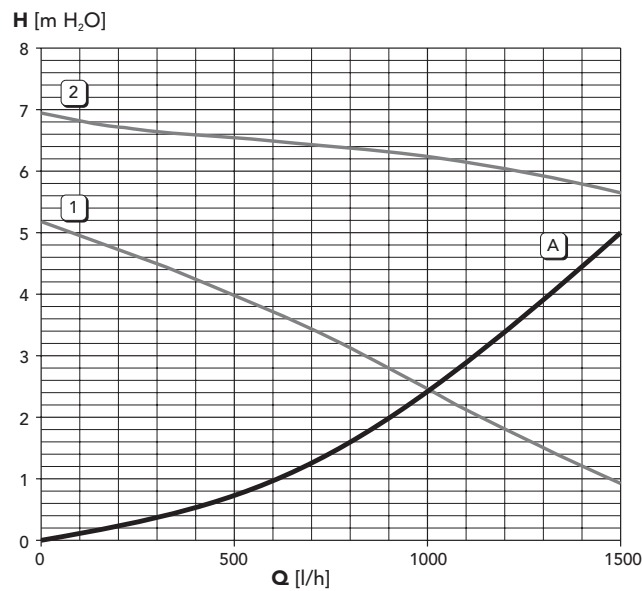

fig. 40

- A Boiler pressure losses
- 1 Circulating pump min. speed
- 2 Circulating pump max. speed

4.6 Wiring diagram

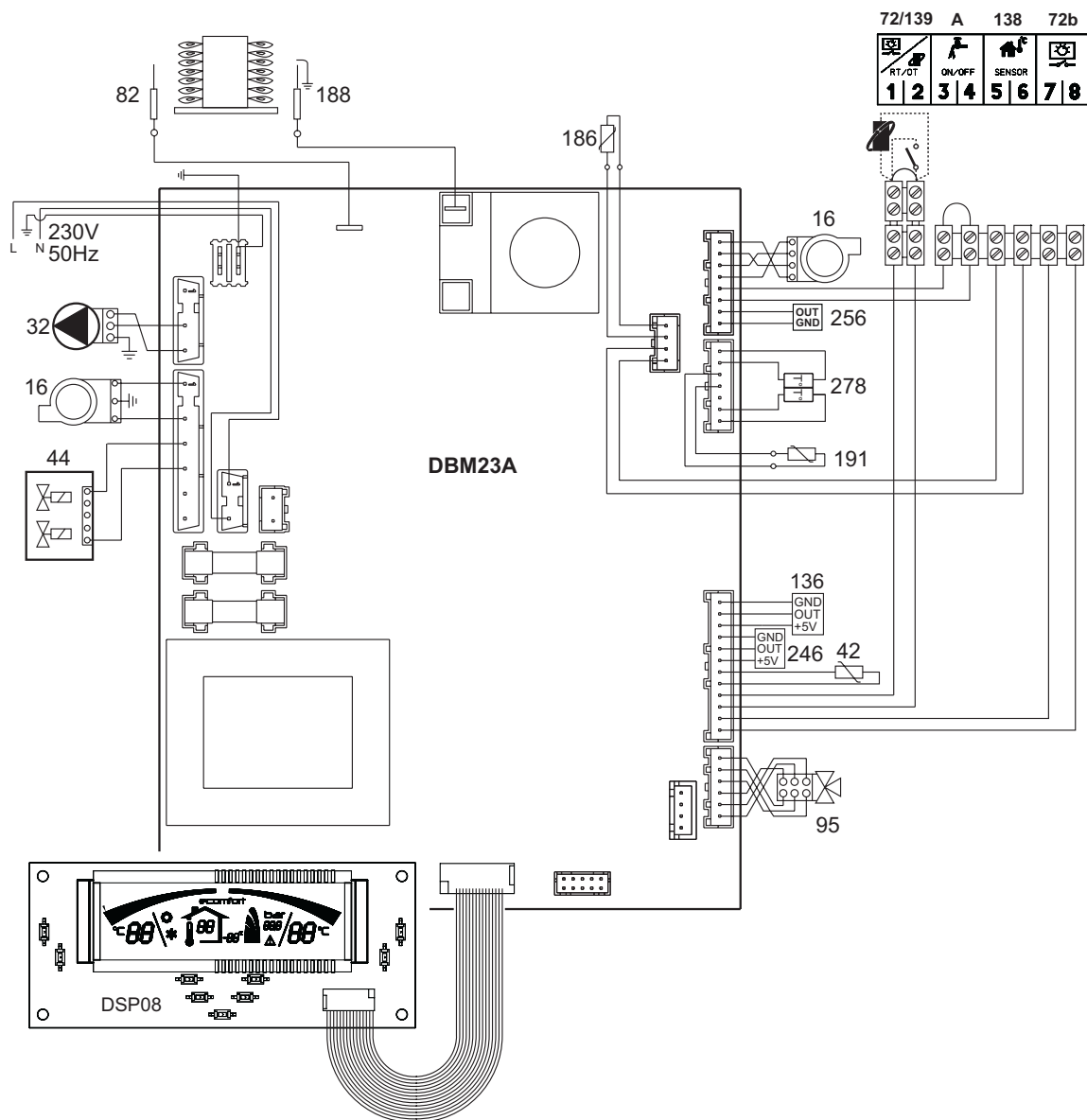

fig. 41 - Wiring diagram



Important: Before connecting the **room thermostat** or the **remote timer control**, remove the jumper on the terminal block.

- | | | | |
|-----|---------------------------------------|-----|--|
| 16 | Fan | 186 | Return sensor |
| 32 | Heating circulating pump | 188 | Ignition electrode |
| 42 | DHW temperature sensor | 191 | Fume temperature sensor |
| 44 | Gas valve | 246 | Pressure transducer |
| 72 | Room thermostat (not supplied) | 256 | Modulating heating circulating pump signal |
| 72B | Second room thermostat (not supplied) | 278 | Double sensor (heating + safety) |
| 82 | Detection electrode | A | Flow meter ON/OFF contact |
| 95 | Diverter valve | | |
| 136 | Flow meter | | |
| 138 | External probe | | |
| 139 | Remote timer control | | |



BENCHMARK No. | 2 | 6 | 7 | | | |

Please add the first 4 digits of the Boiler serial No to complete the BENCHMARK No.

GAS BOILER COMMISSIONING CHECKLIST

BOILER SERIAL No. _____ NOTIFICATION No. _____

CONTROLS To comply with the Building Regulations, each section must have a tick in one or other of the boxes

TIME & TEMPERATURE CONTROL TO HEATING	ROOM T/STAT & PROGRAMMER/TIMER <input type="checkbox"/>	PROGRAMMABLE ROOMSTAT <input type="checkbox"/>
TIME & TEMPERATURE CONTROL TO HOT WATER	CYLINDER T/STAT & PROGRAMMER/TIMER <input type="checkbox"/>	COMBI BOILER <input type="checkbox"/>
HEATING ZONE VALVES	FITTED <input type="checkbox"/>	NOT REQUIRED <input type="checkbox"/>
HOT WATER ZONE VALVES	FITTED <input type="checkbox"/>	NOT REQUIRED <input type="checkbox"/>
THERMOSTATIC RADIATOR VALVES	FITTED <input type="checkbox"/>	
AUTOMATIC BYPASS TO SYSTEM	FITTED <input type="checkbox"/>	NOT REQUIRED <input type="checkbox"/>

FOR ALL BOILERS CONFIRM THE FOLLOWING

THE SYSTEM HAS BEEN FLUSHED IN ACCORDANCE WITH THE BOILER MANUFACTURER'S INSTRUCTIONS?

THE SYSTEM CLEANER USED _____

THE INHIBITOR USED _____

FOR THE CENTRAL HEATING MODE, MEASURE & RECORD

GAS RATE m³/hr ft³/hr

BURNER OPERATING PRESSURE (IF APPLICABLE) N/A mbar

CENTRAL HEATING FLOW TEMPERATURE °C

CENTRAL HEATING RETURN TEMPERATURE °C

FOR COMBINATION BOILERS ONLY

HAS A WATER SCALE REDUCER BEEN FITTED? YES NO

WHAT TYPE OF SCALE REDUCER HAS BEEN FITTED? _____

FOR THE DOMESTIC HOT WATER MODE, MEASURE & RECORD

GAS RATE m³/hr ft³/hr

MAXIMUM BURNER OPERATING PRESSURE (IF APPLICABLE) N/A mbar

COLD WATER INLET TEMPERATURE °C

HOT WATER OUTLET TEMPERATURE °C

WATER FLOW RATE lts/min

FOR CONDENSING BOILERS ONLY CONFIRM THE FOLLOWING

THE CONDENSATE DRAIN HAS BEEN INSTALLED IN ACCORDANCE WITH THE MANUFACTURER'S INSTRUCTIONS? YES

FOR ALL INSTALLATIONS CONFIRM THE FOLLOWING

THE HEATING AND HOT WATER SYSTEM COMPLIES WITH CURRENT BUILDING REGULATIONS

THE APPLIANCE AND ASSOCIATED EQUIPMENT HAS BEEN INSTALLED AND COMMISSIONED IN ACCORDANCE WITH THE MANUFACTURER'S INSTRUCTIONS

IF REQUIRED BY THE MANUFACTURER, HAVE YOU RECORDED A CO/CO₂ RATIO READING? N/A YES CO/CO₂ RATIO

THE OPERATION OF THE APPLIANCE AND SYSTEM CONTROLS HAVE BEEN DEMONSTRATED TO THE CUSTOMER

THE MANUFACTURER'S LITERATURE HAS BEEN LEFT WITH THE CUSTOMER

COMMISSIONING ENG'S NAME PRINT _____ CORGI ID No. _____

SIGN _____ DATE _____

SERVICE INTERVAL RECORD

It is recommended that your heating system is serviced regularly
and that you complete the appropriate Service Interval Record Below.

Service Provider. Before completing the appropriate Service Interval Record below, please ensure you have carried out the service as described in the boiler manufacturer's instructions. Always use the manufacturer's specified spare part when replacing all controls

SERVICE 1 DATE

ENGINEER NAME

COMPANY NAME

TEL No.

CORGI ID CARD SERIAL No.

COMMENTS

SIGNATURE

SERVICE 2 DATE

ENGINEER NAME

COMPANY NAME

TEL No.

CORGI ID CARD SERIAL No.

COMMENTS

SIGNATURE

SERVICE 3 DATE

ENGINEER NAME

COMPANY NAME

TEL No.

CORGI ID CARD SERIAL No.

COMMENTS

SIGNATURE

SERVICE 4 DATE

ENGINEER NAME

COMPANY NAME

TEL No.

CORGI ID CARD SERIAL No.

COMMENTS

SIGNATURE

SERVICE 5 DATE

ENGINEER NAME

COMPANY NAME

TEL No.

CORGI ID CARD SERIAL No.

COMMENTS

SIGNATURE

SERVICE 6 DATE

ENGINEER NAME

COMPANY NAME

TEL No.

CORGI ID CARD SERIAL No.

COMMENTS

SIGNATURE

SERVICE 7 DATE

ENGINEER NAME

COMPANY NAME

TEL No.

CORGI ID CARD SERIAL No.

COMMENTS

SIGNATURE

SERVICE 8 DATE

ENGINEER NAME

COMPANY NAME

TEL No.

CORGI ID CARD SERIAL No.

COMMENTS

SIGNATURE

SERVICE 9 DATE

ENGINEER NAME

COMPANY NAME

TEL No.

CORGI ID CARD SERIAL No.

COMMENTS

SIGNATURE

SERVICE 10 DATE

ENGINEER NAME

COMPANY NAME

TEL No.

CORGI ID CARD SERIAL No.

COMMENTS

SIGNATURE



Before contacting **Lamborghini Caloreclima** please have available the completed **BENCHMARK** document (located in the back of this manual), boiler serial number and model detail.

For Technical assistance during the installation, call our **Technical Service Helpline on 0871 559 2942.** You be required to provide your Gas Safe Register Number.

Should you require a Service Engineer to visit, call our **Service Centre on 0871 559 2944.**

Calls to these numbers are charged at 8 pence per minute from BT landlines. Calls from mobile networks may be considerable more.

The illustrations and data given are indicative and are not binding on the manufacturer. LAMBORGHINI CALORECLIMA reserves the right to make those changes, considered necessary, for the improvement of the product without forwaming the customer.

LAMBORGHINI CALORECLIMA
PO Box 7783
Burton on Trent
DE149GU

