



solaris 24PC 30PC

Pre-Mix Condensing
Combination Boiler

Installation, Servicing
& User Instructions



Natural Gas

Heatline Solaris 24PC/30PC Pre-mix Condensing Combination Boiler

British Gas Service Listing

Solaris 24PC G.C.No 47-157-04
Solaris 30PC G.C.No 47-157-05



The Heat Line™ range of heating boiler are manufactured from high quality materials, enabling reliability and optimum performance.

Heat Line™ are committed to the continual development of their appliances to ensure their customers benefit from the latest advances in combustion technology and energy savings.

Notified Body IMQ 51BP2750
CE Directive 90/396/EEC
CE Directive 92/42/EEC

The manufacturer, in the continuous process to improve his products, reserves the right to modify the data expressed in the present documentation at any time and without prior notice.

The present documentation is an informative support and it cannot be considered as a contract towards third parties.

'Benchmark' Log Book, Boiler Registration & SEDBUK

As part of the industry-wide initiative the boiler comes complete with an Installation, Commissioning and Service Record Log Book. Please read the Log book carefully and in accordance with current legislation, complete all sections relevant to the appliance and installation. The details within the Log Book will be required in the event of any warranty work.

On completion the Log Book, which is found on pages 46 & 47 of the Installation manual, must be left with the end user and the relevant sections completed on each subsequent Service visit.

NOTE: You are also obliged to register the installation of this boiler with C.O.R.G.I. Should you wish to check the SEDBUK website for the rating of this boiler, search under DD HEATING or the boiler name and designation, e.g. SOLARIS 24PC.

For further information or advice (UK) contact Heatline™:

Service please call:

0870 777 8341

Spares please call:

0870 777 8402

Technical assistance please call:

0870 777 8318

Or by E mail on our Web Site on www.heatline.co.uk

Contents

Section	Page
Preface	
1. Installation Regulations	5
2. Technical Data	6
3. Boiler Characteristics	8
4. Operation	8
5. General Installation	9
6. Appliance Siting	11
7. Flue Terminal Location	12
8. Flue (General)	14
9. Electrical Connections	15
10. Boiler Installation	17
11. Gas Supply	19
12. Filling the System	20
13. Control Panel Functions	20
14. Commissioning	22

Section	Page
15. Onboard Adjustments	23
16. Safety Devices	24
17. Routine Servicing	24
18. Component Replacement	27
19. Gas Type Conversion	34
20. Fault Finding Chart	34

Appendices	
Appendix 1. Spare Parts List	39
User Instructions	40

Preface

The Heat Line™ Gas fired combination boiler meets the requirements of Statutory Instrument 'The Boiler (Efficiency) Regulations' and is deemed to meet the requirements of:

- Gas Appliance Directive 90/396/EEC
- Efficiency Directive 92/42/EEC
- Low Voltage Directive 73/23 EEC (modified from 93/68) and;
- Electromagnetic Compatibility Directive 89/396 EEC (modified from 93/68)

Heat Line™ declares that the materials used in the manufacturer of this appliance are non-hazardous and that no substances harmful to health are contained within the appliance.

Warnings

Heat Line™ accepts no responsibility for the unsatisfactory performance of the appliance or flue arising from the failure to comply with the installation and user instructions. Incorrect installation could invalidate your guarantee and may lead to a dangerous situation.

If the appliance is sold on to another customer all documentation must be passed on and the appliance re-registered with Heatline in order to maintain the guarantee.

The boiler must be installed in accordance with these instructions and the regulations currently in force. Read these instructions carefully before installing or using the appliance.

Manual Handling:

As this appliance is heavy it is recommended that you get assistance when lifting. When manoeuvring the boiler always use safe techniques – keep your back straight, bend your knees, don't twist, move your feet. Avoid bending forwards or sideways and keep the load as close to your body as possible. Where possible transport the boiler using a suitable trolley, sack truck or get some assistance. Grip the boiler firmly and before lifting establish where the weight is concentrated to determine the centre of gravity, repositioning yourself if necessary.

The Signs on Box



The sign of approval.
This appliance has been certified
by IMQ



This is a fragile piece of equipment:
Do not drop.



Avoid getting the carton damp or wet



The packed appliances may be
stacked five high.



Do not crush the packaging as this
may damage the appliance.



Store the appliance upright as
indicated on the box.

Access, warnings and connections on the boiler



This picture shows the terminal
block, which is located at the
Room Thermostat bottom left
hand side of the control panel
cover, to which the room
thermostat must be fitted.

NOTE: This is a voltage free connection and no
power must be applied to these terminals. For
mains powered thermostat connection, see section
9.5.

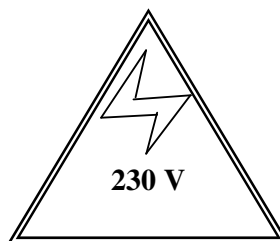

Warning High Voltage!
This sign is located on the
back of the control box
housing warning of high
voltages within the control

box. Turn off and isolate the appliance before
removing this cover. **NOTE:** Take care as there
may be residual voltage within some components.



Potentiometer cover: Removal of
the cover, which is found on the
back of the control box, gives
access to the adjustment
potentiometers. **NOTE:** Do not
make any adjustments without
reading the instructions carefully.

1. Installation Regulations

- 1.1.** This appliance must be installed by a competent person as defined by the Gas Safety (Installation and Use) Regulations. Failure to install this appliance correctly may invalidate your guarantee and may lead to a dangerous situation.
- 1.2.** Your C.O.R.G.I. registered engineer should carry a C.O.R.G.I. ID card containing their registration number, which should be recorded in your BENCHMARK Log Book, which is supplied with the Instructions. You can check the validity of this ID number by contacting C.O.R.G.I. on 0870 401 2300.
- 1.3.** This appliance must be installed in accordance with the Gas (Safety and Use) Regulations, current Building Regulations, Building Standards (Scotland), I.S.813 Installation of Gas Appliances (Ireland), IEE Wiring Regulations (BS 7671), Health and Safety Document No. 635 (Electricity at Work Regulations) and Local Water Authority Bye Laws.
- 1.4.** On installation the following British Standards must also be considered:
- ✓ BS 6798 Specification for installation of gas fired hot water boilers of rated input not exceeding 70kW.
 - ✓ BS 5449 Central heating for Domestic Premises.
 - ✓ BS 5546 Installation of gas hot water supplies for domestic purposes.
 - ✓ BS 5440 Flues and Ventilation for gas appliances of rated input not exceeding 70kW (Part 1 Flues)
 - ✓ BS 5440 Flues and Ventilation for gas appliances of rated input not exceeding 70kW (Part 2 Air Supply)
 - ✓ BS 6891 Installation of low pressure gas pipe-work installations up to 28mm (RI).
- Reference should also be made to British Gas Guidance Notes for Installation of Domestic Gas Fired Boilers.
- 1.5.** Due to the manufacturer's continuous improvement policy the manufacturer

reserves the right to change any specification of the appliance or make modifications to these instructions, which meet current regulations at the time of print. However, the instructions must not be taken as overriding statutory requirements.

- 1.6.** To ensure reliability and continued performance ensure that other components in the system are also approved to relevant standards and that the appliance and system is adequately protected and maintained on an annual basis.
- 1.7.** Your boiler comes with a statutory 1 year guarantee. In order to claim your 2nd years free warranty you must complete and return your guarantee card within one month of the date of installation or ring the telephone number on the label on the front of your appliance.
- Note: Your second year of warranty is only valid if there is evidence of service after the first year of installation. It is recommended that the appliance be serviced annually by a competent person, as defined in the Gas (Safety and Use) Regulations, and the service record maintained in the Benchmark Logbook.

For further information or advice (UK) contact Heatline™:

Service please call: 0870 777 8341
 Spares please call: 0870 777 8402
 Technical assistance please call: 0870 777 8318

or

E-mail via our web site www.heatline.co.uk.

2. Technical Data

		24PC	30PC
Gas Category	II _{2H3+}		
Gas inlet pressure G20	mbar	20	
Heat Input (Q _{max}) (CH)	kW (Btu/h)	25.03	30.5
Heat Output (P _{max}) (CH)	kW (Btu/h)	24.42	29.8
Heat Input (Q _{max}) (DHW)	kW (Btu/h)	31.05	35.8
Heat Output (P _{max}) (DHW)	kW (Btu/h)	30.3	35.01
Heat Input (Q _{min}) (CH/DHW)	kW (Btu/h)	9.26	10.00
Heat Output (P _{min}) (CH/DHW)	kW (Btu/h)	9.35	10.09
Useful efficiency at 100% load	%	97.6	97.8
Useful efficiency at 30% load	%	107.4	107.5
Inlet Pressure (Natural Gas)	mbar	20	
Gas Rate (Natural Gas)	m ³ /h	Max 2.65	Max 3.2
Power supply	Input	230 V 50 Hz	
Gas Diaphragm	mm	6.5	7.0
Air Diaphragm	colour	Red	Red
Max. power consumption	Watts	140	
Level of protection	IPX4D		
Maximum heating temperature	°C	85°	
Max. domestic hot water temperature	°C	64°	
Operating pressure (Bar)	PMS (Min)	3 (0-8)	
Domestic water supply pressure (Bar)	PMS (Min)	8 (0-25)	

Domestic Water Supply Output (liters/min.)	35 °C ΔT 30 °C ΔT 25 °C ΔT	12.20 14.24 17.08	14.35 16.73 20.10
Expansion Vessel	Capacity (litres)	7	
Expansion Vessel	Pre-Charge (bar)	0-5	
Flue Extraction	Diameter (mm)	60/100	
CO ₂ % at max. input ±0.1%	ppm	9	
Nitrogen oxide (NO _x) emissions at max. input (NO _x Class 5)	ppm	20.6	22
Nitrogen oxide (NO _x) emissions at max. input (NO _x Class 5)	ppm	22.6	26
Combustion products temperature (max.)	°C	70	72
Case Dimensions (mm)	330d x 430w x 720h		
Shipping weight	kg	44	45
Dry weight	kg	41	42
G30/G31 VERSION			
Gas Inlet Pressure	mbar	28-30/37	28-30/37
Gas Diaphragm	mm	4.70	5.35
Air Diaphragm	colour	Orange	Red
Gas rate (LPG)	kg/h	1.29	1.52
CO ₂ % at min. input ±0.1%		10	

Figure 1

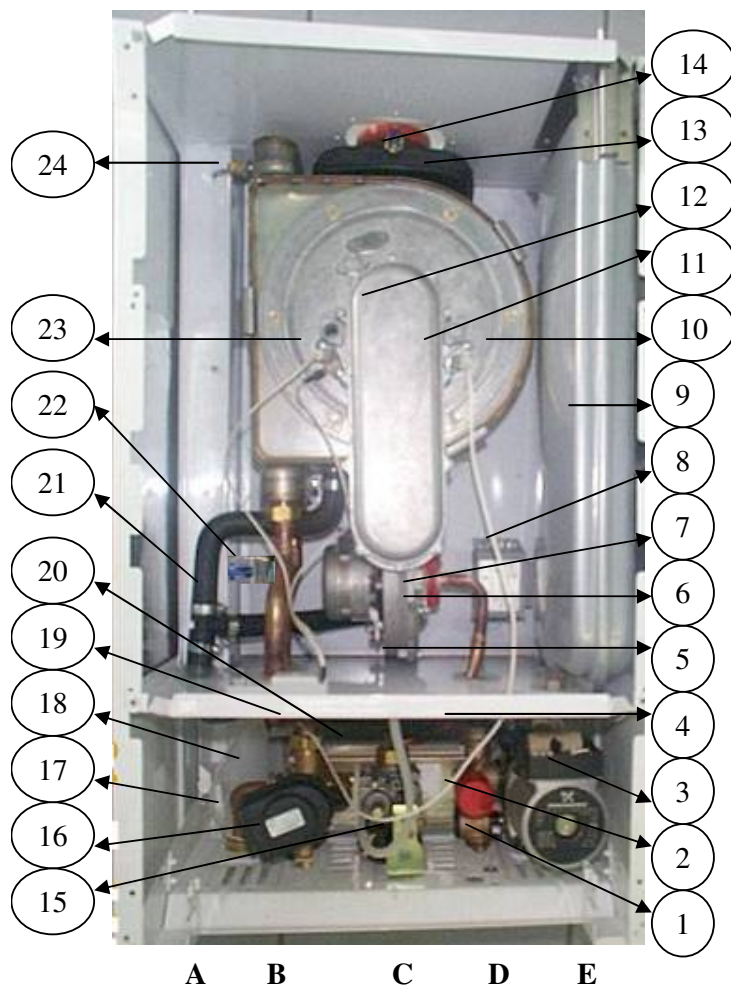

- 1 - D.H.W. Flow Sensor
 - 2 - Water Pressure Sensor
 - 3 - Pump
 - 4 - Pressure Relief Valve
 - 5 - Fan
 - 6 - Air/gas mixer
 - 7 - Air/gas mixer ring
 - 8 - Supply transformer
 - 9 - Expansion Vessel
 - 10- Heat exchanger
 - 11 - Ionisation electrode
 - 12 - Burner
 - 13 - Plastic flue duct
 - 14 - Plastic flue safety thermostat
 - 15 - Gas valve
 - 16 - Diverter Valve
 - 17- DHW temperature sensor
 - 18 - Condensate trap
 - 19 - Overheat Safety thermostat
 - 20 - Secondary Heat Exchanger
 - 21 - Condensate drain pipe
 - 22 - Central heating temperature sensor
 - 23 - Ignition electrode
 - 24 - Manual air vent
-
- A - Heating Flow (22mm)
 - B - D.H.W. Outlet (15mm)
 - C - Gas Inlet (22mm)
 - D - Cold Water Inlet (15mm)
 - E - Heating Return (22mm)

3. Boiler Characteristics.

3.1 The Heat Line boiler is a fan flued, wall-mounted combination boiler that supplies both central heating and mains fed domestic hot water. Being room sealed the boiler may be installed in any room without the need for purpose made ventilation. However, if the boiler is installed in a compartment it is recommended that the compartment is ventilated for cooling purposes. A functional diagram of the boiler's principal components is given in *figure 1, page 7*.

3.2 An electronic control unit, consisting of a PCB which includes ignition module provides direct burner ignition and flame supervision along with continuous modulation of the burner's gas supply.

3.3 An interface unit, which includes boiler adjustment potentiometers and fault display codes provides easy serviceability of the boiler.

3.4 Heat transfer to the boiler's primary hydraulic circuit is obtained via a primary, gas to water heat exchanger contained within a hermetically sealed combustion chamber. A 24 volt, modulated speed fan blows the products of combustion from the combustion chamber to outside air via an associated flue system.

3.5 A secondary heat exchanger allows the instantaneous transferral of heat from the primary hydraulic circuit to water destined for domestic hot water use. The secondary heat exchanger is sized so as to minimise thermal shock and is protected against the build up of lime scale by limiting the D.H.W. outlet water temperature to a maximum of 60°C.

3.6 An integral pump located in the boilers main hydraulic circuit circulates water through the primary heat exchanger to either the central heating circuit or D.H.W. heat exchanger, depending on the demand. In the event of reduced or interrupted water circulation in the central heating circuit, a system by-pass should be fitted, in accordance with current legislation as far away from the boiler as possible. Note: It is no longer

permissible to utilise a non-thermostatic controlled radiator as a by-pass.

3.7 Room temperature can be controlled by the use of an external room thermostat or temperature regulator. Note connection of the room thermostat is dependant on the operating voltage of the thermostat. See section 9.4 & 9.5 for details.

3.8 The C H system temperature can be adjusted automatically to balance heat demand, dependant on the outside temperature, if an outdoor sensor is connected directly to the main PCB. Call Heatline Technical Services for further assistance.

3.9 The boiler incorporates an integrated clock, which allows the setting of central heating periods and the boiler's control panel incorporates an LCD display, which indicates the state of operation and fault defect codes.

4. Operation

4.1 Using the operating switch the boiler can be set to operate either on domestic hot water only or domestic hot water and heating.

Note: *Domestic hot water demand draws preference over heating. During heating periods the boiler will automatically revert back to heating mode, after a draw off of hot water, but there will be a 45sec delay if the No.3 dipswitch is set to the OFF position. See fig 19 page 27.*

4.2 Depending on demand water is either diverted via the three port valve to the secondary water-to-water heat exchanger for domestic hot water or directly to the heating system.

4.3 DOMESTIC HOT WATER MODE:

- On opening a hot water faucet the boiler automatically responds to fire the boiler and supply the water-to-water heat exchanger with hot water via the three port valve, located on the hydro-block. The boilers electronic control unit automatically modulate the burner's output to maintain the required temperature at the faucet. Hot water will

continue to flow until the faucet is closed and the boiler automatically shuts down. Note that the pump will continue to run for a further 10secs to dissipate the residual heat from the boiler.

4.4 DOMESTIC HOT WATER AND CENTRAL HEATING MODE:

- When heating demand is required, i.e. the timer and thermostat are calling for heat, then providing the power is on the boiler will fire automatically. An integral pump is then energised and hot water from the boiler's primary circuit is circulated around the central heating systems pipe-work and radiators. When the demand for central heating is no longer present, either the thermostat reaches temperature or the time clock reaches the end of its set period, the burner will shut down and the boiler will revert to stand-by, waiting to respond to the next heating or hot water demand. The pump will continue to operate for a short period of time to dissipate any excess heat from within the boiler's heat-exchanger. If during the heating period there is a call for hot water this will take preference over heating. When satisfied the boiler will then supply the heating demand as required. Note there may be a 45sec delay depending on how the boiler's dipswitches are set. See section 14.3 for details.

5. General Installation

5.1 Installer Testing & Commissioning Tips

- The installer shall instruct the user in the operation of the boiler, safety devices contained within the boiler and instruction on how to re-pressurise the system if the water pressure falls. The installer should then hand over the instructions and completed Benchmark Logbook.
- The user should be instructed to keep the instructions and logbook in a safe place for servicing and future reference.
- It is important to keep the boiler clear of dust during the installation. In particular, do not allow debris to enter the top of the boiler where the flue connection is made. This may cause the fan outlet to get blocked or combustion chamber to fill with debris and will, of course, cause the boiler to fail to ignite on first ignition. It is recommended that you check the fan outlet before you light the boiler.
- Before you fit the boiler ensure that the pipe work that you are installing is connected to the appropriate connections on the boiler i.e. cold water pipe to cold water inlet, hot water outlet to the hot water tap etc.
- Because the boiler is actually operated, at the end of each production stage, a small amount of water is retained within the boiler when packed. Please ensure that you spin the pump rotor manually before firing the boiler.
- Remember to thoroughly flush the water circuits in order to remove any fluxes and debris from them. This should be done particularly where boilers are being fitted to existing radiator circuits.
- Refer to BS 7593:1992 for the details to clean DHW and Central heating system.
- **This boiler has been factory set and does not require any adjustments to the gas valve or fan speed.**
- Remember to release the small cap, 1 turn, on top of the automatic air vent, located on top of the pump, before filling. This will ensure that air is vented from the pump as the system fills.
- **Do not use the pressure relief valve as a means of flushing the system.** please use the valve below the pump. Discharging water from the system via the pressure relief valve may leave debris on the valve seat allowing water to seep after you have left the job. This will cause the boiler to lose pressure and the boiler to lockout.
- The boiler is fitted with inlet filters both on the cold water inlet and the central heating return. If you are unable to obtain hot water at the faucet it is likely that the cold water inlet valve filter has become blocked, whilst blockage of the filter on central heating return valve will cause the heater to lock out at the overheat thermostat as the water flow is reduced.

- If you are able to obtain hot water but not heating it is also advisable to check the clock connections and that the room thermostat and time clock are calling for heat.
- Remember that after hot water draw off there is a 45 sec delay before the heating will fire up if No.3 dipswitch is in the OFF position, *see fig 19 on page 27*.
- When commissioning the boiler check the inlet pressure is at 20mbar and burner pressure against the Technical data on *page 6*.
- Note an anti-cycle delay time can be set up to a maximum of 255 seconds by adjusting potentiometer 2 as described in section 15.4 *on page 27*.

If you experience any problems please refer to the installation and commissioning guidelines within the boiler instruction manual. If necessary, please contact Heat Line™ Enquiries:

For further information or advice (UK) contact Heatlin™:

Service please call:
0870 777 8341

Spares please call:
0870 777 8402

Technical assistance please call:
0870 777 8318 **NOTE – FOR INSTALLERS:**

REMEMBER IT IS A LEGAL REQUIREMENT TO COMPLETE THE BENCHMARK CODE OF PRACTICE LOGBOOK BEFORE LEAVING THE INSTALLATION.

5.2 The boiler is designed to operate on fully pumped, pressurised sealed systems operating at a maximum of 3bar pressure and maximum design flow temperature of 85⁰C.

5.3 The boiler's integral expansion vessel is pre-charged to a pressure of 0.5bar and will accommodate a system volume of 125l at an average water temperature of 75⁰C and maximum system pressure of 3bar. If the system volume is more than 125l an additional expansion vessel must be fitted to suit the size of the system. A

Figure 2 – Note the filter valve supplied should be fitted to the heating return pipe, which is on the extreme right of the boiler as shown below.

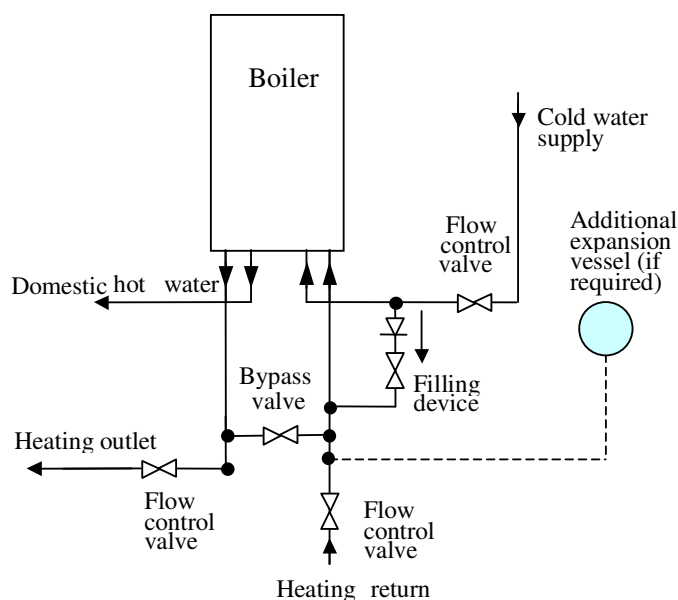

5.4 The heating circuit should be designed and balanced to give a 20⁰C temperature rise across the boiler flow and return.

5.5 When fitting a new boiler to an existing system the system must be thoroughly flushed in accordance with the recommendations of BS7593 prior to installation.

5.6 It is recommended that the system should be protected by an anticorrosion inhibitor.

5.7 On installation it is important to ensure that the heat exchanger is not a natural collection point

for air and where possible, the system pipe work should have a gradient to ensure any excess air is carried naturally to other purpose made, air release points.

5.8 The system's water must always be allowed to circulate whenever the circulation pump is running. A return by-pass must be provided.

NOTE – It is no longer permissible to use non-thermostatic radiator valves to allow by-pass through a radiator.

5.9 In high water volume systems or under floor heating systems where prolonged operation of the boiler is expected at temperatures below 60°C, a by-pass must be installed on the boiler outlet in order to prevent condensation forming inside the boiler body. Failure to comply with this requirement will invalidate the manufacturer's guarantee.

5.10 The pressure relief discharge must be directed away from any electrical equipment or where it could cause a hazardous situation and terminated in a safe but visible position.

5.11 To enable adequate drainage of the system drain cocks compliant with BS2879 must be fitted at the lowest points in the system pipe-work.

5.12 To obtain the best hot water performance from your boiler it is suggested that the cold water supply to the boiler is taken directly from the incoming mains water supply.

Note that the boiler will not operate unless there is a minimum pressure of 0.25bar with a flow rate of 2.5l/min. Where inlet pressures exceed 8bar, a pressure regulator must be fitted to the cold water supply.

5.13 Where cold water mains are fitted with a water meter, check valve(s) or loose jumper stopcock it is recommended that a domestic hot water mini-expansion vessel may need to be fitted.

5.14 Although the boiler is designed to inhibit the formation of scale, in hard water areas above 200mg/l, a proprietary scale reduced should be fitted in the cold water supply to the boiler.

5.15 To obtain the best hot water performance from your boiler it is suggested that supplies to faucets are run in 15mm copper, as short as possible and where practical, be insulated to reduce heat loss.

5.16 The boiler incorporates a frost protection thermostat. Therefore if the boiler will not be used for long periods of time during cold weather, in order to avoid freezing the electric supply must be left ON and all the central heating isolation valves must be left open. The internal frost thermostat will then operate the boiler if the temperature falls too low. However, if the electrical supply is to be turned off the boiler, the heating system and domestic hot water circuit must be drained.

6. Appliance Sitting

6.1 If the boiler is to be installed in any room or compartment, it requires no purpose made ventilation for **combustion air**. If sited in a room containing a bath or shower then particular reference is drawn to the current I.E.E. Wiring Regulations and local Building Regulations.

6.2 The boiler is not suitable for external installation unless protected by a purpose made building such as a boiler house.

6.3. The following clearances are recommended for installation purposes; 200mm above, 300mm below and 20mm at each side. 600mm is required at the front but this may be upon opening a cupboard door.

6.4 The boiler must be sited at least 1m away from flammable materials and combustible walls must be protected with appropriate insulation.

6.5 The wall on which the boiler is mounted must be sufficiently strong enough to support the weight of the boiler.

6.6 A condensate drain pipe must be fitted to allow discharge of condensate to a drain or soakway. Note condensate is acidic and should be discharged through plastic or suitable corrosion resistant pipes.

Where possible condensate should be discharged into the household internal drainage system. If this is not practical, discharge can be made into an external drain. If neither of the above options are possible then condensate must be discharged into a purpose designed soakway.

It is recommended that any external condensate pipe is insulated and increased to 32mm diameter in order to prevent the condensate from freezing.

6.7 For compartment installation the requirements of BS6798 and BS5440: Part 2 must be met.

- The compartment must be of sufficient size to permit access for inspection and servicing or the removal of the boiler and any ancillary equipment.
- Any space used for airing clothes or storage must be separated from the appliance by a non-combustible partition. Where the partition is formed from perforated material, then the major dimension of the apertures shall not exceed 13mm.
- No combustible surface must be within 20mm of the boiler casing without protection.
- There must be 20mm clearance between the compartment door and boiler case.
- Where the boiler's flue pipe passes through the airing space, it must be protected by a non-combustible sleeve or fire stop having a minimum clearance of 20 mm between the flue pipe and sleeve. In addition, if the flue pipe passes through the partition then the clearance gap of the flue pipe or its guard with the partition must not exceed 13 mm.

6.8 When the boiler is intended for use with LPG it must not be installed in a room or internal space below ground level.

7. Flue Terminal Location

7.1 The flue terminal must be sited with minimum clearances as specified in *Figure 3*. Note if plumbing becomes problematic or causes a nuisance a plume management kit is available from your stockist.

7.2 Current regulations and standards require a terminal guard to be fitted where the terminal is accessible to touch or at risk of being damaged. All wall mounted terminals sited within 2m of the level which people have normal access, should be adequately protected with a suitably sited guard

7.3 Where the flue terminates within 1m of a plastic or painted gutter or within 500mm of painted eaves then protection should be provided in the form of an aluminium shield at least 1m in length, fitted to the underside of the gutter or painted surface.

7.4 The flue should not be sited where the condensate "plume" may give rise to a nuisance factor under certain weather conditions.

NOTE: If you have difficulty siting the flue in an appropriate location your supplier will be happy to supply a "anti-plume management kit", which discharges the flue products at a higher level or a deflection elbow, which deflects the plume to the left or right.

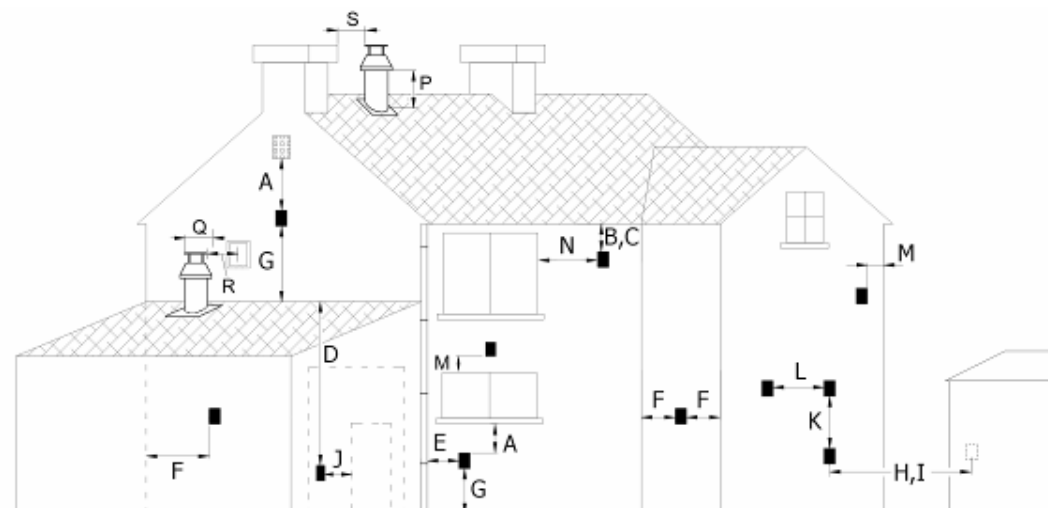
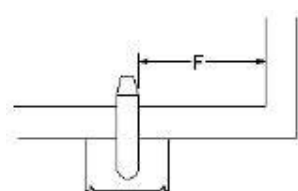
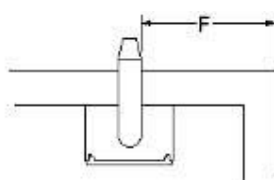

Figure 3

TERMINAL POSITION		MINIMUM DISTANCE
A-	Directly below an openable window or other opening e.g. air brick	300 mm
B-	Below gutters, soil pipes or drain pipes	75 mm
C-	Below eaves	200 mm
D-	Below balconies or car front roofs	200 mm
E-	From vertical drain pipes and soil pipes	150 mm
F-	From internal or external corners	300 mm
G-	Above ground, roof or balcony level	300 mm
H-	From a surface facing a terminal	600 mm
I-	From a terminal discharging towards another terminal	1200 mm
J-	From an opening in a car port (e.g. door, window) into a dwelling	1200 mm
K-	Vertically from a terminal on the same wall	1500 mm
L-	Horizontally from a terminal on the same wall	300 mm
M-	Above an opening, air brick, opening windows, etc.	300 mm
N-	Horizontally to an opening, air brick, opening windows, etc.	300 mm
P-	Above roof level (to base of terminal)	300 mm
Q-	From adjacent wall to flue	300 mm
R-	From an adjacent opening window	1000 mm
S-	From another roof terminal	600 mm



Internal Corner



External Corner

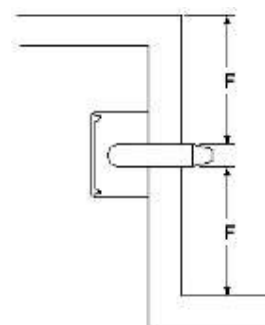

Double Corners

8. Flue (General)

8.1 The boiler utilises a concentric flue arrangement which consists of a 60mm-diameter inner flue and 100mm-diameter outer air inlet duct.

8.2. A standard 700+/-5mm flue kit (*figure 4*) is supplied with the boiler, which can be routed to the rear, left or right of the appliance by means of a 90° degree bend (*figure 5*). The bend is connected to the boiler using the screws provided and sealed with the gasket.

Figure 4

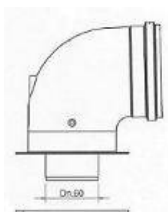
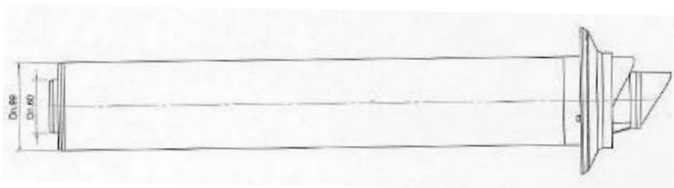

Figure 5

8.3. The horizontal 60/100cm flue pipes may be extended up to a maximum of 7m using additional spare components available from your supplier.

8.4. A vertical 60/100cm flue kit is also available (*figures 6a & 6b*) from your supplier up to a maximum length of 8m. The terminal is suitable for a flat or pitched roof.

8.6. The connection of the vertical flue system is similar to the Horizontal flue connection. However, the 80/125 system is connected with screws to the boiler and the vertical extension pipes and roof terminal are connected by clips as shown in *figure 6b, item 3*.

Note. For each additional 90° elbow used the maximum flue length must be reduced by 1.5 m, whilst the use of 2 x 45° bends warrants a reduction of 2m.

WARNING!

ONLY A HEATLINE APPROVED FLUE IS TO BE USED WITH THIS PRODUCT. FAILURE TO COMPLY WITH THIS REQUIREMENT WILL INVALIDATE YOUR GUARANTEE AND MAY LEAD TO A DANGEROUS SITUATION.

Figure 6a

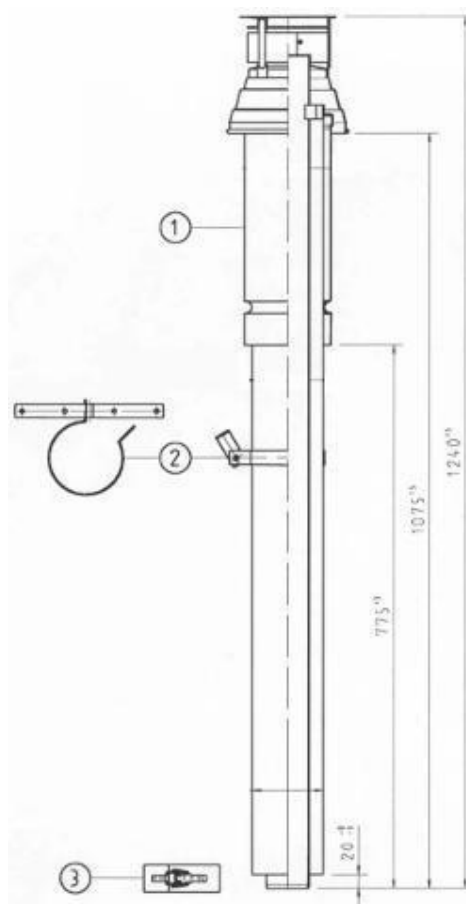
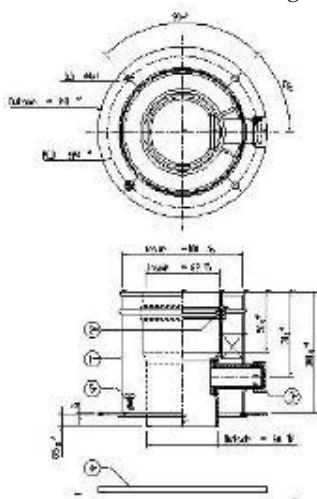

Figure 6b



9. Electrical Connections

9.1 The boiler is supplied factory wired complete with 1.5 m of mains fly lead. All electrical connections to the mains supply must be made in accordance with the current I.E.E. regulations.

9.2 The boiler must be connected to an effective earth system. Using the cable supplied the boiler may be connected via a 5 amp fused three pin plug to an unswitched shuttered socket outlet. However if the boiler is installed in a room containing a bath or shower regulations dictate that disconnection must be incorporated in the fixed wiring with a switch provided for disconnection from the mains supply having a contact separation of at least 3 mm on all poles and fused at 5 amp.

9.3 The point of connection must be readily accessible, at a distance no further than 1.5m adjacent to the appliance and provide complete electrical isolation for the boiler and control system.

9.4 The low voltage room thermostat terminal block is located on the back left side of the control box (figure 7). On connection of a voltage free room thermostat to the boiler, the factory fitted bridge across the room thermostat terminal connectors must be removed. If a mains voltage thermostat is to be used the please refer to *figure 8*.

9.5 Mains powered thermostats must be connected directly to the mains circuit board as indicated in *Figure 8*.

9.6 Ensure that the polarity of the mains connection is correct as reversed polarity may cause the appliance to malfunction.

9.7 While the boiler's main PCB, pump, three-way valve and gas valve are supplied at 230V a.c., all other components and associated circuits are supplied at low voltage.

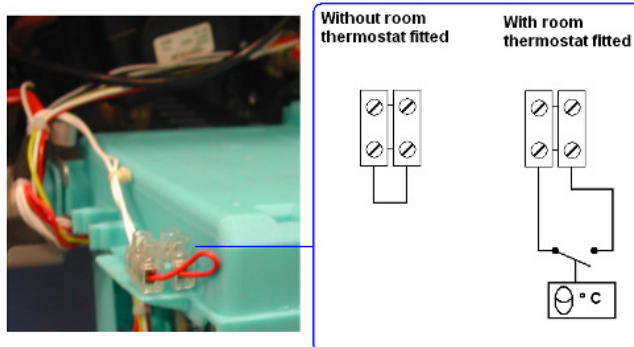

9.8 On connecting the mains electrical supply to the boiler, it is essential to ensure that electrical safety checks for earth continuity, earth resistance, polarity and short circuit are carried out prior to making the final connection. A diagram of the boiler's electrical circuit is given in *figure 8*.

9.9 Fuse Ratings F1 and F2 are 3.15A fast

Bertelli & Partners Circuit Board

F1 – 3.15A fast

F2 – 3.15A fast

F3 – 3.15A fast

SIT Circuit Board not used

F1 – not used

F2 – not used

Warning: On no account must any external voltage be applied to any of the terminals on the heating control connection plug.

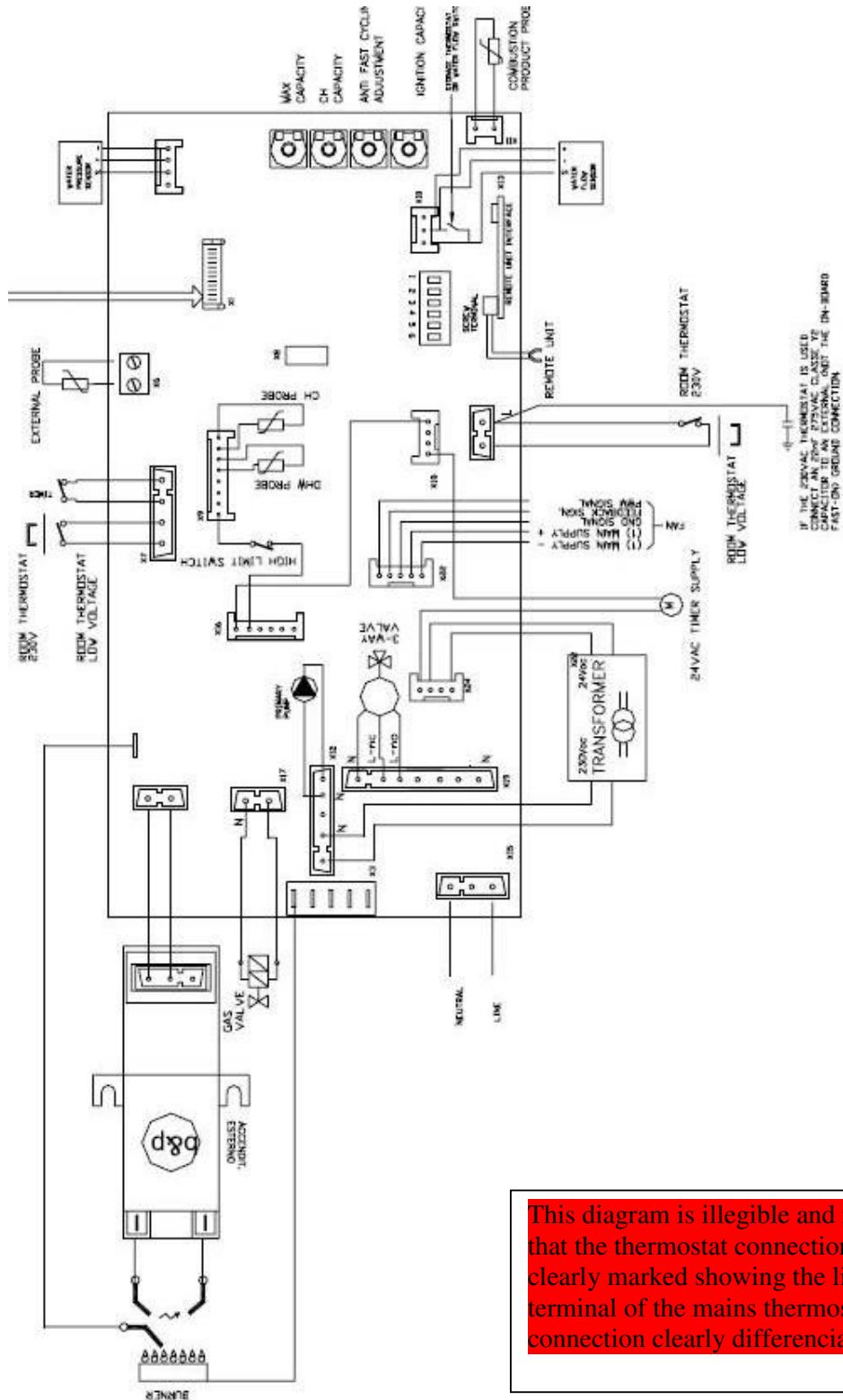

This diagram is illegible and requires that the thermostat connections are clearly marked showing the live terminal of the mains thermostat connection clearly differentiated.

Important Note.

Connection to the mains electrical supply must be maintained at all times in order to provide domestic hot water, frost protection, anti seizure protection of the pump and pump over-run facility. Ensure that the boilers electrical supply is not interrupted by any external controls.

10. Boiler Installation

10.1 Manual Handling: This appliance is heavy and it is suggested that it should be lifted by two people. When manoeuvring the boiler always use safe techniques truck if possible and obtain assistance if required – when lifting keep your back straight, bend your knees, don't twist, move your feet. Avoid bending forwards or sideways and keep the load as close to your body as possible. Where possible transport the boiler using a suitable trolley, sack truck or get some assistance. Grip the boiler firmly and before lifting establish where the weight is concentrated to determine the centre of gravity, repositioning yourself if necessary.

To remove the appliance:

1. Carefully slit or remove the sealing tape being careful not to scratch the appliance door.
2. Fully open the carton lid and remove the condensate hose and mounting bracket.
3. Roll the carton onto its open face.
4. Lift the carton free of the inner packaging.
5. Remove and valve package and instructions.
6. Stand the boiler on its base within the styrene block and remove the top packaging piece.
7. If you wish to remove the styrene base lie the appliance on its back to do so.
8. Read the instructions carefully before installation of the appliance.

10.2 Prior to installing the boiler check the contents of the carton: Appliance, Valves, Condensate hose, Wall Hanging Bracket, Mounting Template, Service, Installation and User Manual, which includes the Benchmark Log Book, and Guarantee Card. The boiler dimensions are given in *figure 9*.

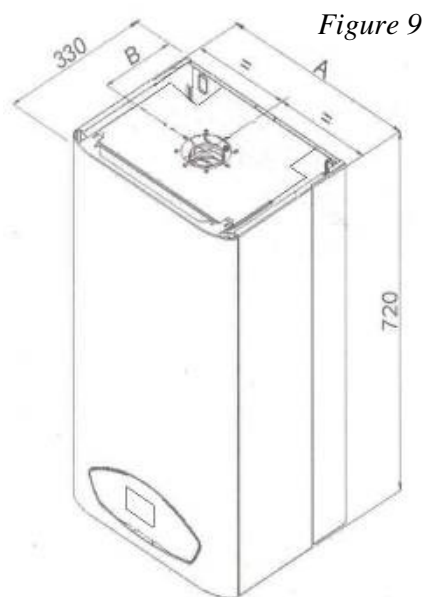

A: 430 mm
B: 128 mm

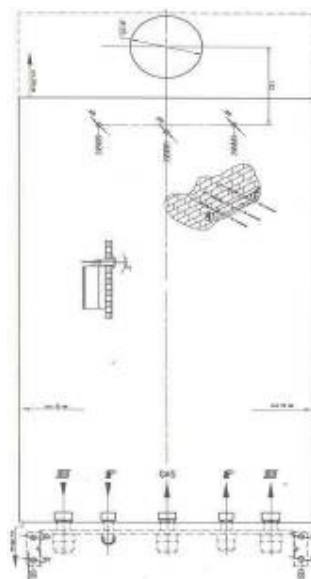

Figure 10

Bottom
Fixing Jig (Optional)

Give dimensions between valves

10.4 Position the supplied template on the wall, ensuring it is level both vertically and horizontally (*figure 10*). Mark the boiler fixing jig locations (if used), wall bracket fixing positions and flue outlet position (rear flue only). For flue side exit from the boiler - Mark the horizontal flue centre line on the rear wall. Extend the horizontal line to the side wall allowing a **3% decline back towards the boiler**, to enable condensate to drain back through the boiler. Mark the flue centre line. (*figure 11.*)

Figure 11 (vertical Centre??)

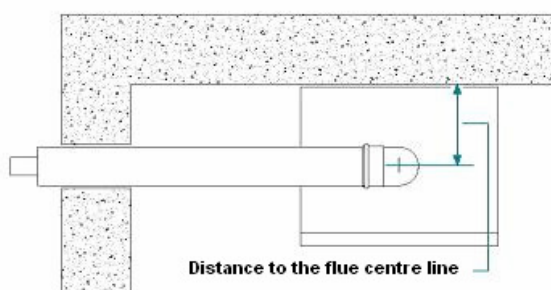

10.5 When cutting the flue hole it is recommended that a 105mm diameter core drill is used where both internal and external access for the flue installation is available. Where only internal access is available a 125mm diameter core drill should be used. (Note: Please take adequate precautions to prevent debris entering the boiler via the flue outlet).

10.6 Using a 8.5mm drill bit, drill the holes for fixing jig (optional) and hanging bracket. Locate and secure the supplied wall mounting bracket and fixing jig (if obtained) in position (*figure 12*).

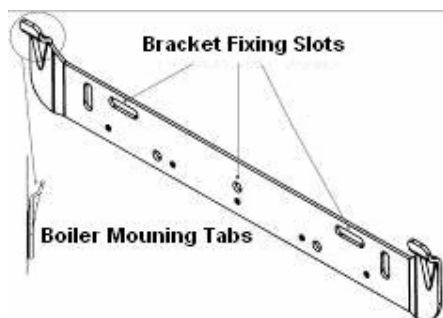

Figure 12

10.7 Mount the boiler onto the fixing bracket via the boiler mounting tabs, (*figure 12*).

10.8 Connect the isolation valves to the boiler ensuring the filter valve is at the extreme right and the sealing washers are fitted correctly.

10.9 On installing the flue, determine the required length of the **outer air duct** by measuring the distance 'L' (*figure 13*) from the face of the external wall to the back of boiler's elbow connecting collar. The measurement for the **inner flue duct** will be 'L' + 20mm

10.10 Measuring from the back of the terminal connection, mark distance 'L' onto the outer air duct. (*figure 13*)

10.11 Cut the **outer air duct only** to the required length ensuring that the cut is square and free from burrs.

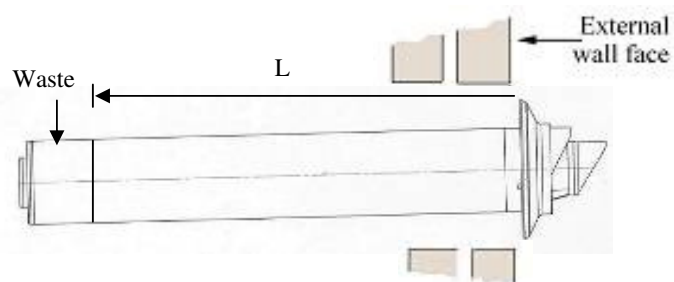

10.12 Measuring from the back of the terminal connection, mark distance 'L' + 20mm (*figure 14*) onto the inner flue duct and cut the duct to size, ensuring that the cut is square and free from burrs.

10.13 Pass the flue assembly through the wall and connect the assembly to the boiler, ensuring that both the air and flue duct joints are fully pushed home into the connecting elbow's collar.

10.14 With the flue tilted at 3°, allowing condensate to drain back into the boiler, and joints secured fit the flue trim to the external wall surface using a suitable mastic. **Note.** Where internal access only is available, the flue trim must be attached to the flue assembly prior to passing the assembly through the wall.

10.15 The vertical system diagram is shown in figure 15a and 15b. Note: Maximum vertical flue length is 8m with a 60/100mm flue system.

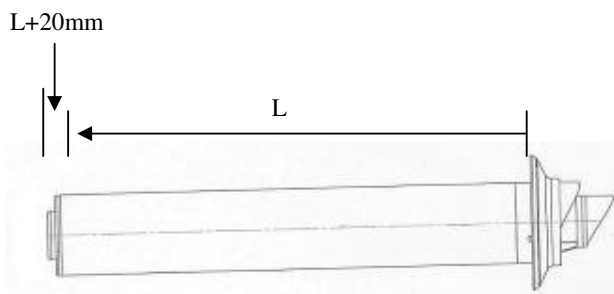

Figure 15b

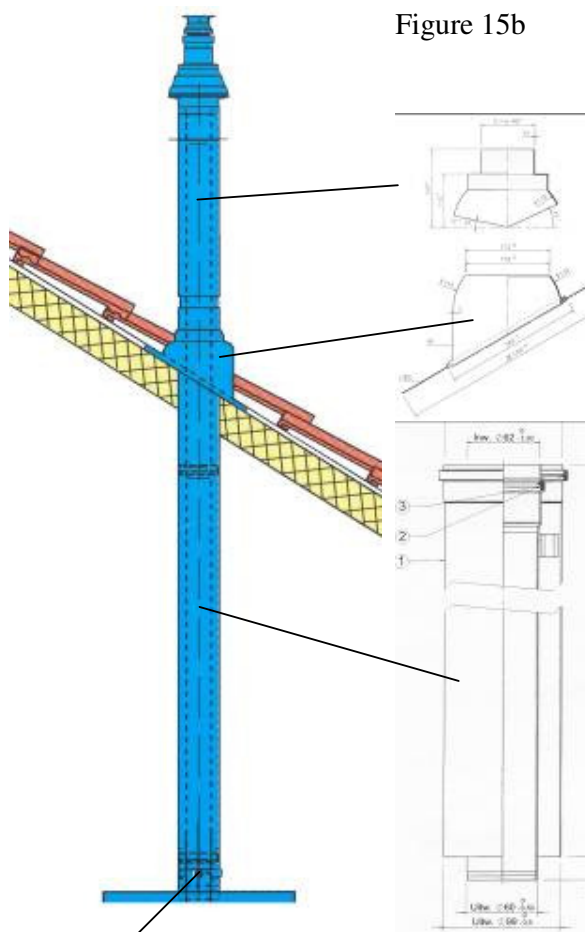

Figure 15a

10.16 Provisions to fill the boiler and system must be made by the Installer, using an approved filling loop. The filling loop used must be approved to current water byelaws and fitted as close to the boiler as practicable.

If it is not practicable to install the filling loop in an obvious position please add a label on the boiler to state where the filling loop can be found for future reference. Please instruct the user how to top up the system water pressure.

10.17 Connect the domestic hot water, cold water inlet, heating system flow & return and pressure relief valve pipework to the supplied boiler fittings, ensuring that the pipework has been correctly power flushed before final connection.

10.18 Condensing boilers of this type must have the condensate drain connected to drainage system. Due to the acidic nature of the condensate the drainage system must be made of non-corrosive material such as plastic tubing. Condensate should, if possible, be discharged into the internal household draining system. If this is not practical, discharge can be made externally into the household drainage system or a purpose designed soak away containing lime chippings. Note if a soak away is used the drain must terminate at least 500mm from the external wall.

10.19 The electrical connections to the boiler must be in accordance with Section 9 of these instructions.

11. Gas Supply

11.1 The gas supply pipe must be of 22mm copper from the meter to the boiler and capable of delivering the quantity of gas required by the boiler (see Technical Data section 2) in addition to the demand of any other gas appliances being serviced from that supply.

11.2 The meter governor must be capable of delivering a pressure of either 20mbar for natural gas or 37mbar for propane gas, dependant on the gas being used.

11.3 On final connection of the gas supply to the boiler, the complete gas installation including the gas meter, must be tested for tightness and purged.

12. Filling the System

12.1 The boiler must not be operated without water.

12.2 On completion of the boiler installation and ensuring that all water connections are correctly made the boiler may be filled with water via the filling loop (not supplied with the boiler). Ensure that two manual feed valves and boiler isolation valves are open.

12.3 Release the cover cap on the boiler's automatic air vent, located on top of the internal pump (*figure 16*), when filling the system.

Figure 16

Release the cover cap
(behind the pump)
When filling system



12.4 The manual feed valves must be closed and the filling loop disconnected once the pressure sensor, sited on the boiler's control panel, indicates a system pressure of 1.5bar.

12.5 Check that all the water connections throughout the system are sound and bleed each of the heating system's radiators in turn.

12.6 Air must be vented from the boiler's pump by unscrewing the pump's integral vent plug and allowing water to bleed for a few seconds. Take care not to allow water to splash onto any electrical components.

12.7 When the system is bled of any air the system pressure must be topped until the pressure LCD display indicates a system pressure of 1.5bar.

12.8 If the pressure exceeds 1.5bar discharge the excess pressure from the system via a radiator valve or pipe connection. Do not use the safety discharge valve as the valve seat

may become contaminated with debris and fail to re-seal.

Important Note.

In order to maintain operation and the appliance's warranty; after initial filling the heating system must be thoroughly flushed using a propriety cleanser to remove foreign material and contaminants and dosed with sufficient anti-

13. Control Panel Functions

13.1 Central heating and D.H.W. temperature controls: The boiler's integral control unit monitors and adjusts both the boiler's hydraulic circuit and D.H.W. water outlet temperatures by means of sensors located on the C/heating and D.H.W. flow outlets. The sensors convert the water temperature into an electrical resistance that is relayed back to the control potentiometers (2 & 3 *figure 17*) located on the control panel. The respective potentiometer control dial allows manual setting of the maximum required temperature (reference value) between 30° and 85°C for C/heating and 35° and 64°C for D.H.W. When the boiler functions in heating or D.H.W. mode, the resistance measured is compared to the manually set reference value. The differential determines the modulation of the gas valve adjusting the useful heat output generated and stabilising the temperature to within +/-1°C

13.2 Re-set function: Should the boiler lock-out at any time, please check the gas supply and ionisation probe position, the boiler may be re-started by turning both the CH & DHW to minimum, switching to the standby "O" position and switching off at the fused spur or socket (*Switch 4 figure 7*) waiting 30 seconds and switching back to its previous position once the fault has been eliminated.

13.3 Function switch: The three position switch allows the boilers operation to be set to Stand-by (centre position - O) 'Heating + D.H.W.' (left) or 'D.H.W. only' (right).

Figure 18

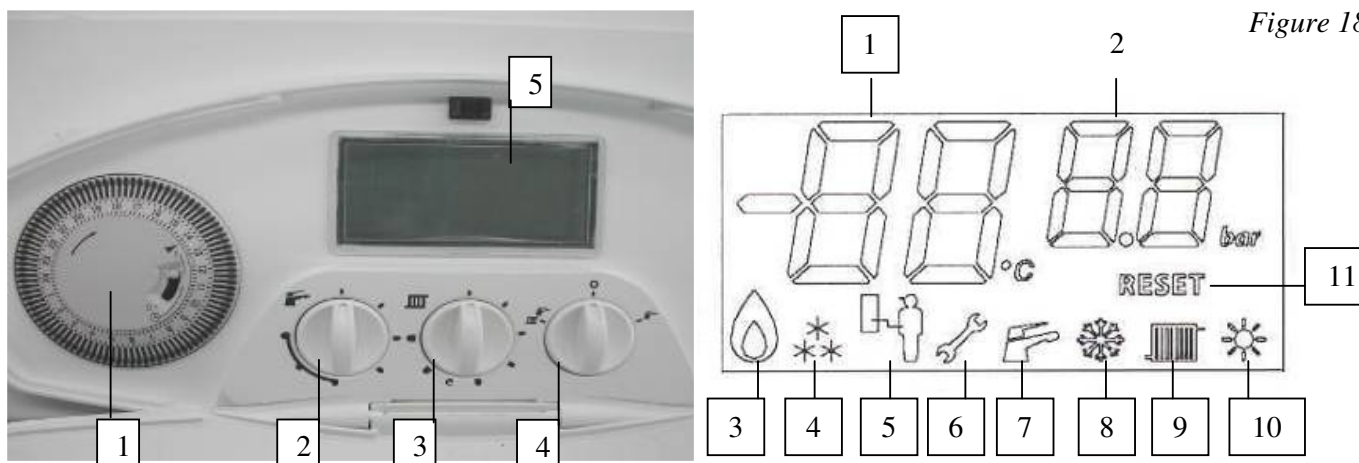

1-	Mechanical Timer
2-	D.H.W. temperature control
3-	C/Heating temperature control
4-	Function switch
5-	LCD display

13.4 LCD display: While giving the operational status of the boiler and water temperature, to aid in fault diagnostics the control unit has a built in facility that automatically indicates the fault mode. If more than one fault simultaneously occurs, then only the highest priority fault is displayed.

Service mode function: Turn selector control knob (3 figure 17) 3 times between C/H setting and the off position (no more than 2 seconds between each turn) the boiler is now in service mode and will stay there for 15mins, turn both C/H & DHW controls to max, this sets the boiler to max output and will not modulate, turn both the controls to min to set the boiler on min without modulation for setting up the default parameters.

- 1- C.Heating/D.H.W. water temperature and failure code indicator
 - 2- C.Heating water pressure value indicator
 - 3- Flame indication
 - 4- Frost protection indicator
 - 5- Service computer connection indicator
 - 6- Failure indicator
 - 7- D.H.W. mode indicator
 - 8- Winter mode indicator (Heating & Hot Water)
 - 9- C. Heating mode indicator
 - 10- Summer mode indicator (Hot Water Only)
- Reset indicator

Failure Codes:

F0 – The Water Pressure is Too LOW or Too HIGH

F1 - Lockout due to overheating

F2 - D.H.W. temperature sensor damage

F3 - Primary temperature sensor damage

F4 - Ignition problem

F5 - Combustion product (flue) temperature sensor damage

F6 - External temperature sensor damage

F7 - Problem with fan feedback signal

F8 - Fan speed out of set range

F9 - Fan is moving when it should be stationary

OC - External sensor is connected and OTC enabled

CC - External sensor is disconnected and OTC disabled and Flue sensor

14. Commissioning

14.1 The boilers have been tested and pre-set at the factory and is dispatched with its on board controls set to provide a maximum central heating and D.H.W. output of 24 kW for Solaris 24, and 30kW for Solaris 30. Consequently, once all the connections have been made and the boiler has been filled with water to the designed system operating pressure, the boiler may be fired prior to adjustment of its pre-set parameters to match the heating systems requirements.

14.2 Prior to firing, check that the electrical supply to the boiler is 'On' (Indication is shown on the LCD display) and the gas service cock is in the open position.

- Set the boiler's central heating and domestic hot water temperature controls to maximum by turning them fully clockwise.
- Set the external room thermostat (if fitted) to maximum and set thermostatic radiator valves to maximum.

14.3 Switch the boiler's function switch to the central heating and domestic hot water position. The boiler's control unit will now automatically carry out pre-ignition safety checks before igniting the burner.

14.4 On burner ignition check the integrity of the boiler's flue for tightness and correct operation.

14.5 Check the boiler for correct domestic hot water operation by opening and closing the household domestic hot water draw off faucet.

14.6 In order to maintain the appliance warranty after initial filling the heating system must be thoroughly flushed using a propriety cleanser to remove foreign material and contaminants and dosed with sufficient anti-corrosion inhibitor.

14.7 Restart the boiler and again allow the

central heating system to reach maximum operating temperature. Check that all the water connections throughout the system are sound and bleed each of the heating systems radiators and purpose made air release points in turn.

14.8 Check manual air vents, and bleed the heat exchanger by means of the screw on the manual air vent.

14.9 Check the system pressure and top up if necessary to 1.5bar.

14.10 Reset the central heating & domestic hot water temperature controls and room thermostat to the desired temperature settings.

Important Notice.

- Failure to thoroughly power flush the boiler and heating system or to add an anti corrosion inhibitor to the system water will invalidate the boiler's warranty.
- The condensate trap must be filled with water and plastic discharge pipe connected to drain before operating the boiler.

15. Onboard Adjustments

15.1 The boiler incorporates 4 potentiometers and a bank of dip switches to allow adjustment to its pre-set parameters. These are situated on the rear of the control panel. (*figure 19*)

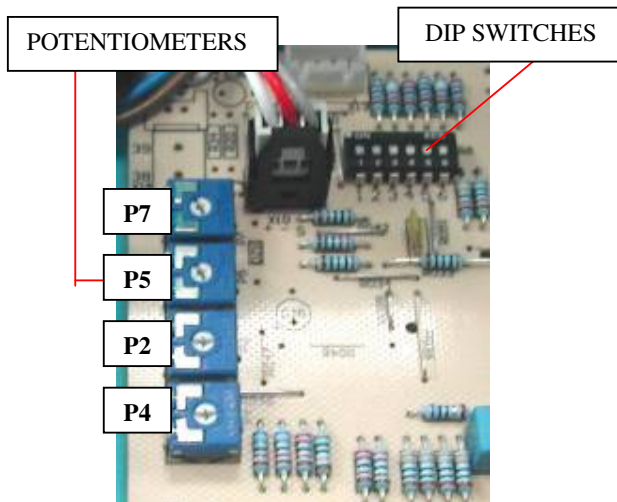
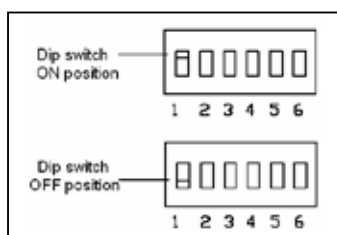
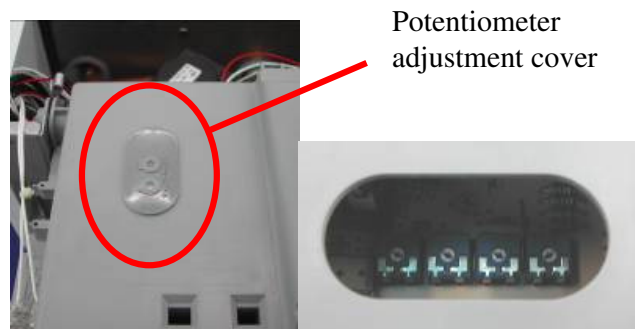

Figure 19



The potentiometers can easily be accessed by removing the cover on the rear of control panel (*Figure 20*). However, to reach the dip switches, the control panel must be opened.

- P7 – Ignition fan ramp
(default setting 4 0'clock)
- P5 – Anti cycle timer adjustment
(default setting 6 0'clock)
- P2 - Boiler range adjuster
(default setting 4 0'clock)
- P4 – Maximum Fan sped adjustment
(default setting 4 0'clock)



15.2 Setting the maximum c/heating flow temperature: The boiler is dispatched with a maximum flow temperature factory set to 85°C. Where a lower maximum temperature is required such as in the case of under-floor heating, the factory setting can be altered between a maximum of 50°C and a minimum of 30°C, by setting dip switch '6' into ON position.

15.3 Setting the 45 second delay: The boiler is factory set to exclude the delay of 45 seconds before re-ignition between the closing of a hot water faucet and CH start-up. This delay can be set to 45 seconds by setting dip switch '3' (*figure 19*) into the OFF position.

15.4 255 seconds delay setting: The boiler is capable of up to 255 seconds ignition delay (anti cycling time) before re-ignition following burner shut down on the primary hydraulic water reaching its set temperature. This delay can be increased up to a maximum of 255 seconds by turning potentiometer P5 (*Figure 19*) clockwise.

15.5 Pump working mode setting: The boiler has a factory set to operate the pump for pre-purge and post-purge times (45 sec.). This delay can be excluded by fitting dipswitch '2' (*figure 19*) into ON position. However, this may then cause the boiler over-heat thermostat to trip out.

15.6 The maximum and minimum heat output for heating is adjusted via potentiometer P2 (*figure 19*) which changes the fan speed and thus the gas rate. It is not necessary to make further adjustments.

15.7 Ignition fan ramp. The graduated opening of the gas valve for ignition rate is governed by the 1st potentiometer P7 control, which is factory set to 4 o'clock. Adjustment from minimum to maximum rate is made by turning the potentiometer fully clockwise.

15.8 The boiler's integral pump is factory set to its maximum speed setting to give a 1000 l/hr flow on a nominal 4m head. The pump may be adjusted to a lower speed to match the designed c/heating system requirements. (figure 22)

Important .

Dip Switch 4 and Dip Switch 5 (figure 19) are factory set and must not be adjusted.

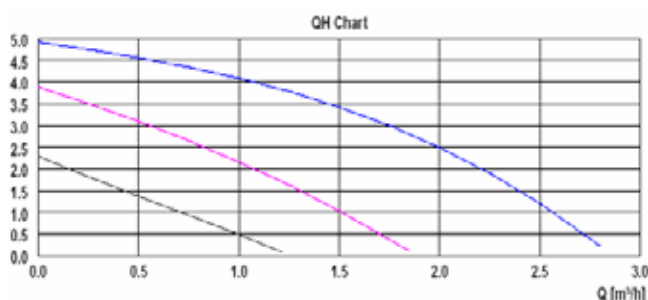

16. Safety Devices

16.1 An hydraulically operated primary pressure sensor monitors water pressure in the primary hydraulic circuit and will flash should the pressure drop below 0.8bar, and switch off the boiler if the pressure drops below 0.3bar or rises above 3bar. The boiler will not operate until the correct system pressure has been correctly re-stored and the boiler reset, see 13.2.

16.2 The temperature of the water flowing from the primary heat exchanger is monitored by an overheat thermostat located on the outlet pipe. If the water temperature gets too hot the switch opens, cutting off the electrical supply to the gas valve and causing the boiler to 'Lock-out'. Once activated the boiler has to be manually re-set. Refer to section 13.2.

16.3 The boiler's control unit has an in-built frost protection device that fires the boiler's burner when the temperature of the primary hydraulic water falls below 6°C. The device works irrespective of any room thermostat setting and will protect the complete heating system. Once the water temperature reaches 16°C the boiler reverts back to normal operation.

16.4 If there is a fault on the DHW sensor, the boiler continues to operate by controlling DHW outlet temperature by using the CH temperature sensor, which limits the water temperature at 65°C during DHW operation. If such a failure occurs a fault code will be displayed on the LCD display, please contact your service agent.

17. Routine Servicing

17.1 To ensure the continued efficient and safe operation of the boiler it is recommended that it is checked and serviced regularly. The servicing must be carried out by a competent person in accordance with the Gas (Safety and Use) Regulations. The frequency of servicing will depend upon the particular installation conditions and usage, but in all cases the boiler must be serviced at least once a year.

17.2 Following servicing of the boiler the relevant sections of the 'Benchmark' Installation, Commissioning and Servicing Log Book must be completed.

17.3 Prior to servicing check the flue operation, terminal guard (if fitted) and the boiler's operation.

17.4 Ensure that both the electrical and gas supplies to the boiler are isolated before commencing service of the boiler.

17.5 Remove the boiler casing as follows:

- Open the front panel by removing two screws at the bottom of the boiler (figure 23).



Figure 23

17.6 Release the hermetic chamber cover by removing the two screws (figure 24) and then lifting the cover to release it from the retaining hooks at the top of the boiler.



Figure 24

- Release the side panels by removing the screws on the upper and lower sides (figure 25). Remove the panels by swinging them out and lifting them up.

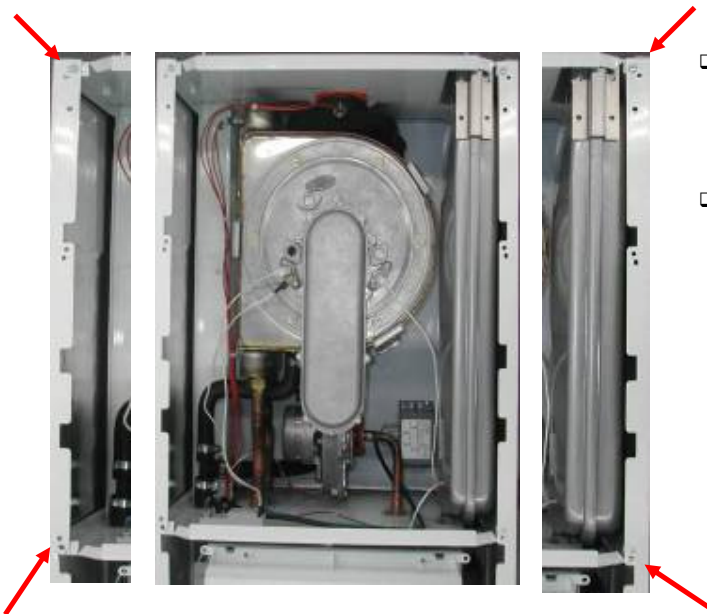

17.7 Disconnect the electrical leads and gas valve pipe connection from the fan (disconnect at the gas valve taking care not to damage the restrictor), remove the fan securing screws.

Figure 26



Figure 27



17.8 Remove the burner assembly from the combustion chamber as follows:

- Disconnect and remove the gas supply pipe between the gas valve and fan, taking care not to damage the restrictor in the top of the gas valve.



Figure 28

- Pull off the ignition and flame electrode leads from the PCB and ignition transformer, and remove the wires through the grommet on the lower combustion chamber.
- Remove the burner-retaining nuts and extract the burner (figure 30).



Figure 29

Ignition
electrodes

Ionisation
electrode



Figure 30

Burner

Premix
heat
exchanger

17.9 Visually check for debris/damage and clean or replace as necessary the following items:

- ⇒ Heat exchanger
- ⇒ Burner
- ⇒ Fan/compartament
- ⇒ Electrodes
- ⇒ Insulation/gaskets

IMPORTANT

- ❖ Clean the heat exchanger using a soft brush or vacuum cleaner. **Do not** use any tool likely to damage the finish of the heat the exchanger.
- ❖ Clean the burner by washing in soapy water. Allow to dry thoroughly before re-fitting.
- ❖ **Do not** use wire or sharp instrument to clean the burner ports.
- ❖ **Ensure the ignition electrode gap is set to 4 mm.**
- ❖ **Ensure the electrodes are 7mm from the burner surface.**
- ❖ **Ensure the Ionisation probe is 8mm from the burner surface.**

17.10 Cleaning the Condensate trap. Extract the bottom part of condensate trap, by turning anti-clockwise. If this is difficult to remove then dependant on which trap is used either use an appropriate spanner or pull off the hose from the bottom of the trap and use an appropriate allen key in the socket provided. Clean the trap using a household proprietary cleanser, preferably containing bleach.

17.11 The boiler is fitted with a cold water inlet filter, which must be inspected during each service. To gain access to the filter:

- ❑ Close the isolating valve on boiler's cold water inlet by turning the valve head full clockwise.
- ❑ Open one or more hot water taps to drain boiler circuit.
- ❑ Disconnect the cold water inlet connection to the boiler.
- ❑ Clean and inspect the filter, replace if necessary as described in **(18.18)**.
- ❑ Re-fit the filter and reinstate the cold water inlet connection to the boiler.
- ❑ Fully open the isolating valve on the boiler's cold water inlet and check for leaks.

17.12 On completing the service reassemble the boiler components in reverse order ensuring that all component joints and gaskets are sound. Any damaged gaskets must be replaced.

17.13 Reinststate the boiler's electrical and gas supplies and check for gas tightness and correct boiler operation.

18. Component Replacement

CAUTION!

While there are no substances harmful to health contained within this appliance, some component parts of the boiler (insulation pads, gaskets and rope seals) are manufactured from man made fibres. When damaged or broken these fibres may cause a temporary irritation. High dust levels may irritate eyes and upper respiratory system. It is important therefore, that sensible precautions are applied when exchanging components.

18.1 Ensure that both the electrical and gas supplies to the boiler are isolated before replacing any component part.

18.2 To prevent the need to drain the entire heating system when replacing the boiler's integral pump, expansion vessel, safety relief valve and pressure sensor, the boiler's hydraulic circuit may be isolated from the central heating circuit by closing the boilers isolation valves. Opening the drain valve at the back of the pump will then drain the boiler's hydraulic circuit.

18.3 For replacement of the following components it will be necessary to remove the boiler casing panels as described in Section 17.

18.4 Domestic hot water sensor

- ❑ The domestic hot water probe is located on the left side of the diverter valve, hot water side. (*figure 31*)
- ❑ Carefully disconnect the leads from the sensor.
- ❑ Remove the sensor using a 13mm spanner.
- ❑ Fit the replacement sensor sealing as required.
- ❑ Re-fit the leads to the replacement sensor

Figure 31



18.5 Central heating and Flue sensor

- ❑ The Central heating ntc sensor is located on the flow pipe.
- ❑ The Flue sensor is located on the plastic flue socket.
- ❑ Disconnect the leads from the sensors.
- ❑ Remove the sensors from the pipe/plastic flue.
- ❑ Fit replacement sensors.
- ❑ Fit the leads to replacement sensors.



Central heating
NTC sensor

Figure 32

Flue NTC
sensor



18.6 Fan Unit

- ❑ Remove the burner/fan assembly as in 17.8.
- ❑ Remove the electrical leads from the fan.
- ❑ Disconnect the fan.
- ❑ Fit the replacement fan unit in reverse order and reconnect all electrical leads before reassembling to the combustion chamber.

18.7 Printed circuit board (PCB)

- ❑ Turn off and isolate electrical supply.
- ❑ Remove interface cover by lifting the two latches. (figure 33)
- ❑ Remove the electrical connections to the PCB, taking note of where the connections are fitted, by releasing the clips and carefully pulling off the connectors.
- ❑ Release the 5 screws securing the PCB to the control panel and lift out the PCB.
- ❑ Fit the replacement PCB in reverse order of removal, ensuring that the PCB electrical connections are fully pushed home.
- ❑ Check that the on board adjustments to the same value as the old PCB. Re-set as necessary, ref section 15.1.



Figure 33



Figure 34



Figure 35

- ❑ Fit the replacement motor in reverse order ensuring the correct polarity of the electrical connections.
- ❑ Open the isolating valves on the flow and return connections, refill, vent and re-pressurise the water system ensuring the pump union joints are sound.

18.8 Pump

- ❑ The order of removal is different dependant on the failure of the motor or plastic body.

In case of motor failure:

- ❑ Drain the boiler's hydraulic circuit as detailed in 18.2.
- ❑ Disconnect the screws connecting the pump motor to the body, figure 34.
- ❑ Pull out the motor and disconnect the electrical connections from the pump cable housing.

In case of body damage:

- ❑ Remove the motor as described above.
- ❑ Remove the secondary heat exchanger as detailed in 18.9.
- ❑ Remove the expansion vessel pipe by releasing the clip on the pump body.
- ❑ Remove the pressure sensor connection as detailed in 18.16.
- ❑ Disconnect the pumps outlet fitting.



Figure 36

- ❑ Remove the fixing screws on the pump and hydraulic block, located at the bottom right of the boiler. (figure 37)



Figure 37

- ❑ Remove the pump body assembly.
- ❑ Detach the pump body from the hydraulic block by removing the clip.
- ❑ Fit the replacement body in reverse order ensuring that the pump washers are fitted and correct polarity of the electrical connections.
- ❑ Open the isolating valves on the flow and return connections, refill, vent and re-pressurise the system ensuring the pump union joints are sound.

18.9 Secondary Heat Exchanger

- ❑ Drain the boiler's hydraulic circuit as detailed in 18.2.
- ❑ Remove the two screws, which connect the heat exchanger to the hydraulic block. (figure 38)

Figure 38

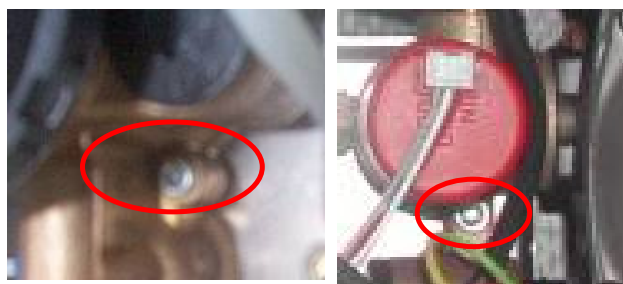

- ❑ Remove the heat-exchanger after removing the diverter valve as described in section .



Figure 39

- ❑ Fit the new heat exchanger and reassemble the boiler in reverse order ensuring all washers are fitted. (Replace and damaged washers or seals)
- ❑ Open the isolating valves on the flow and return connections, refill, vent and re-pressurise the system ensuring all joints are sound.

18.10 Primary Heat Exchanger and Burner

- ❑ Drain the boiler's hydraulic circuit as detailed in 18.2.
- ❑ Disconnect the pipes from the heat exchanger.
- ❑ Release the union connections on the pump and hydraulic block, retaining the washers for re-assembly, replace if damaged.
- ❑ Remove the pump, heat-exchanger and heat-exchanger three-way valve connecting pipes.
- ❑ Remove the burner as detailed in 17.8.

- ❑ Remove the fixing brackets on the heat-exchanger shown in *figure 40*

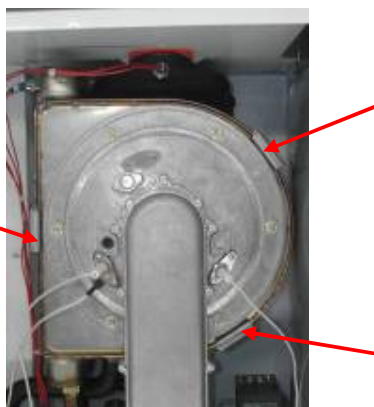

Figure 40



Figure 41

- ❑ Remove the gas valve's two securing screws and washers from the bottom side of boiler.



Figure 42

- ❑ Remove the heat exchanger and burner by pulling forward.
- ❑ Fit the new heat exchanger and reassemble the boiler in reverse order ensuring all washers are fitted. (Replace any damaged washers or seals as required)
- ❑ Open the isolating valves on the flow and return connections, refill, vent and re-pressurise system ensuring that all joints are sound.
- ❑ Check the manual air-vent, and vent the air from the heat exchanger by means of screw on manual air-vent.

18.11 Gas valve

- ❑ Ensure that gas supply to boiler is turned off.
- ❑ Disconnect the electrical connections to the gas valve, and silicone tube.
- ❑ Release the main gas supply tube connection from the top of the gas valve and manifold inlet.

- ❑ Rotate the gas pipe and withdraw the gas valve assembly, taking care not to lose the restrictor in the top of the valve.
- ❑ Remove the restrictor and fit into the new valve.
- ❑ Refit in reverse order of removal, replacing both washers as required.
- ❑ Check for gas tightness and correct boiler operation.
- ❑ Where necessary the gas valve settings may be re-calibrated by the following method:

18.12 Zero adjustment setting

- ❑ Insert a combustion analyser into the socket on the flue adapter.
- ❑ Remove the brass screw to access the adjustment socket. (*Figure 43*)
- ❑ Turn the boiler's function switch to the 'heating/hot water' position. (*4 figure 17*)
- ❑ Turn the central heating temperature control to maximum setting. (*2 figure 17*)
- ❑ Turn Potentiometers P2 & P4 (*figure 19*) anticlockwise to the minimum setting.

- Using a 4mm allen key **adjust clockwise:** to increase the CO₂ setting, **anticlockwise:** to decrease the CO₂ setting by means of a 4mm allen key. (Natural Gas 9%, LPG 10%)

After adjustment, insert the brass screw and re-set the potentiometers as follows P7, P2 & P4 to 4

Figure 43

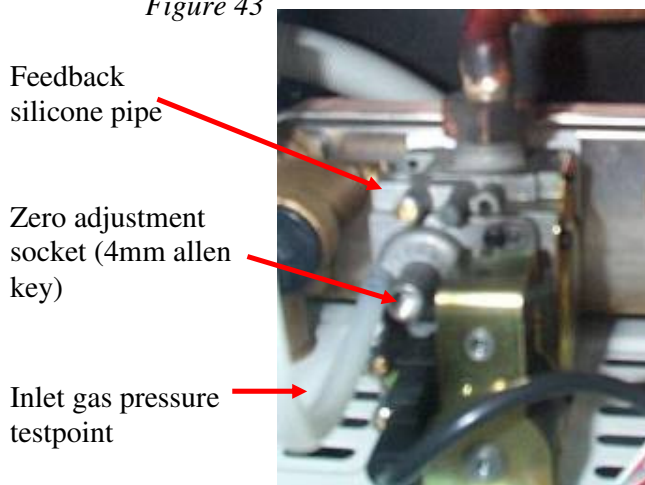

18.13 Expansion vessel

- Drain the boiler's hydraulic circuit as detailed in 18.2.
- Disconnect the pipe coupling on the expansion vessel (figure 44).



Figure 44

- Remove the side panels (figure 25).
- Remove the securing bracket. (figure 45)
- Lift the pressure vessel out of boiler from the gap over the chasis and fit the replacement vessel to the boiler in reverse

order of removal ensuring the sealing washer is fitted to the pipe connection before tightening. (Replace the washer if required)

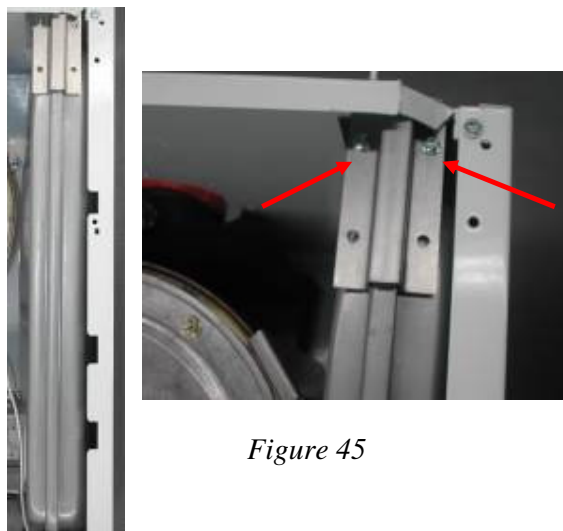

Figure 45

- Using a pressure sensor, check that the expansion vessel charge pressure is 0.5bar (7.5psi) re-charge if necessary.
- Open the isolating valves on the flow and return connections, refill, vent and pressurise the boiler ensuring all joints are sound.

18.14 Overheat safety thermostat

- Remove the front panel. (figure 23)
- Locate the overheat safety thermostat upstream of the three way valve (figure 46)..
- Disconnect the electrical connections from the thermostat.
- Remove the thermostat from the pipe being careful not to damage the retaining clip.
- Fit the replacement thermostat in reverse order to removal.

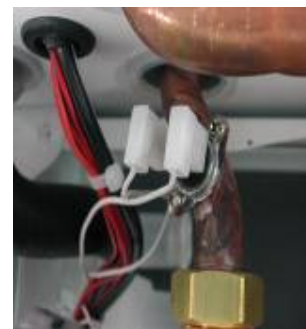

Figure 46

18.15 Pressure relief valve.

- ❑ Drain the boiler's hydraulic circuit as detailed in 18.2.
- ❑ Disconnect the discharge pipe on the outlet of safety valve.
- ❑ Disconnect the safety valve from the hydraulic block retaining the o-ring for use on reassembly.
- ❑ Fit the replacement safety valve in reverse order to removal and refill, vent and pressurise the boiler ensuring all joints are sound.



Figure 47

18.16 Pressure sensor

- ❑ Drain the boiler's hydraulic circuit as detailed in 18.2.
- ❑ Disconnect and remove the sensor cable and sensor from the flow sensor housing. (figure 48)
- ❑ Fit the replacement pressure sensor in reverse order ensuring the gasket is correctly fitted. (Replace the gasket if damaged)

18.17 Flow sensor housing

- ❑ Drain the boiler's hydraulic circuit as detailed in 18.2.
- ❑ Remove the secondary heat exchanger as detailed in 18.9.

- ❑ Release the pump outlet pipe nut and rotate the pipe for ease of removal.
- ❑ Remove the pump, motor and body together with the flow sensor housing as detailed in 18.8.
- ❑ Remove the section of the housing from the pump by releasing the clip.



Figure 48

18.17 Flow sensor housing

- ❑ Drain the boiler's hydraulic circuit as detailed in 18.2.
- ❑ Remove the secondary heat exchanger as detailed in 18.9.
- ❑ Release the pump outlet pipe nut and rotate the pipe for ease of removal.
- ❑ Remove the pump, motor and body together with the flow sensor housing as detailed in 18.8.
- ❑ Remove the section of the housing from the pump by releasing the clip.
- ❑ Disconnect the diverter valve motor electrical connection and remove the motor by releasing the clip as described in 18.20.
- ❑ Release the nut connecting CH outlet connection to the diverter valve (figure 49).



Figure 49

- ❑ Disconnect DHW sensor as described in 18.4.
- ❑ Remove the screw securing the remaining section of the diverter valve to the combination boiler (figure 50).



Figure 50

- ❑ Fit the replacement diverter valve and flow sensor housing (figure 51) in reverse order of removal ensuring all components are assembled correctly.

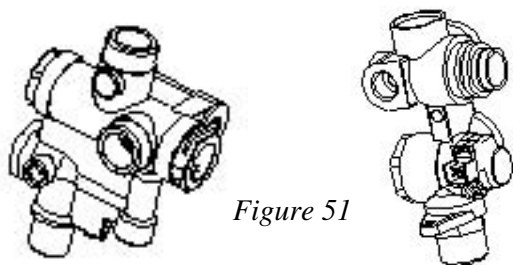

Figure 51

- ❑ Open the isolating valves on the flow and return connections, refill, vent and pressurise boiler ensuring all joints are sound.

18.18 Filter

- ❑ Drain the boiler's hydraulic circuit as detailed in 18.2.
- ❑ Remove the flow sensor housing as described in 18.8.
- ❑ Remove the filter on the inlet of the housing.
- ❑ Clean or fit replacement filter.
- ❑ Assemble the components in reverse order of removal ensuring all components are assembled correctly.
- ❑ Open the isolating valves on the flow and return connections, refill, vent and pressurise the boiler ensuring all joints are sound.

18.19 Flow sensor

- ❑ Remove the flow sensor by using a pair of snipe nose pliers (figure 52).



Figure 52

- ❑ Fit the replacement sensor in reverse order to removal, using the cable connector if required.

18.20 Diverter valve

Figure 44

- ❑ Ensure that the electric supply to the boiler is isolated from the mains supply.
- ❑ Disconnect the electrical connection from the diverter valve motor (figure 53).



Figure 53

- ❑ Remove the clip connecting the motor to the diverter valve (figure 54).



Figure 54

- ❑ Fit the replacement valve in reverse order ensuring the valve is fitted correctly.

19. Gas Conversion**Warning**

Gas conversion must be carried out by a competent person as defined in the Gas Safety (Installation and Use) Regulations.

19.1. If gas conversion is required (from NG to LPG etc.), follow the instructions below using only approved components from your agent:

- ❑ A flue gas analyser must be used when making any adjustments that can affect the combustion characteristics of the boiler. (this includes converting to a different gas type)
- ❑ Fit the new air/gas mixer ring after disconnecting the gas pipe from the gas valve (see figure 26.
- ❑ Adjust dip switch 1 (*figure 19*) to the “On” position for LPG, “Off” for NG, on the main circuit board.
- ❑ Change the diaphragm, which is located in the outlet of the gas valve. {LPG 24kW - 4.7mm (Brown), LPG 30kW - 5.35mm (Grey), NG 24kW – 6.5mm (Black), NG 30kW – 7.0mm (White)}
- ❑ Once re-assembled check for gas tightness.
- ❑ Set the CO₂ as described in section “Zero adjustment” following the instructions in section 18.12 noting the correct CO₂ value for the type of gas that will be used.
- ❑ Check the boiler for correct operation.

Important.

Gas type conversion must be completed by attaching the labels included in the gas conversion kit to the boiler.

- Type of gas label – place in a visible position inside the boiler.
- Grey label – cover the existing gas type on the data plate.
- Instruction label – Position inside the drop down cover on the front of the boiler.

NOTE:

When installing, commissioning or servicing a gas appliance that incorporates a pre-mix burner and zero-set governor, because it is not possible to measure an operating pressure the engineer should first check that the gas supply is metered and ascertain whether it is possible to measure the gas rate. If the gas input rate can be measured then the requirements of GSIUR 26(9) can be met, including any specific requirements in manufacturers' instructions. If gas input rate cannot be measured then, to satisfy the intent of GSIUR 26(9), the engineer shall measure the combustion quality of the appliance in accordance with BS 7967 or the technical data of this manual.

If the engineer does not have the required equipment and no alternative test is specified by the manufacturer then the appliance shall be turned off and disconnected as an un-commissioned appliance until such time that equipment is available to undertake such tests.

20. Fault Finding Chart

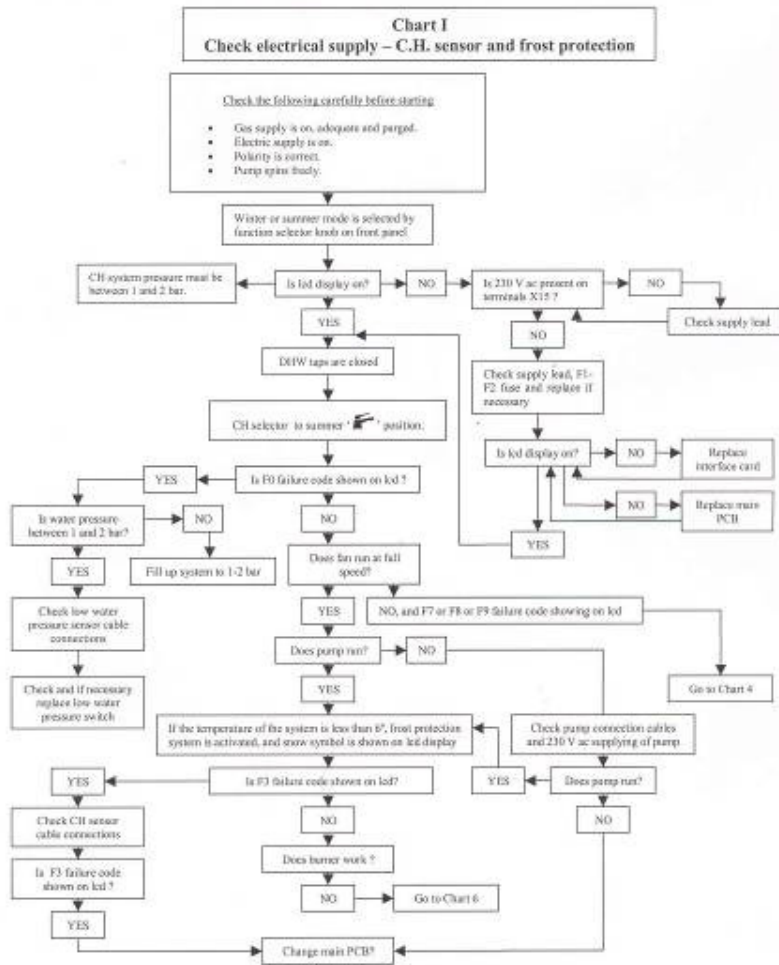
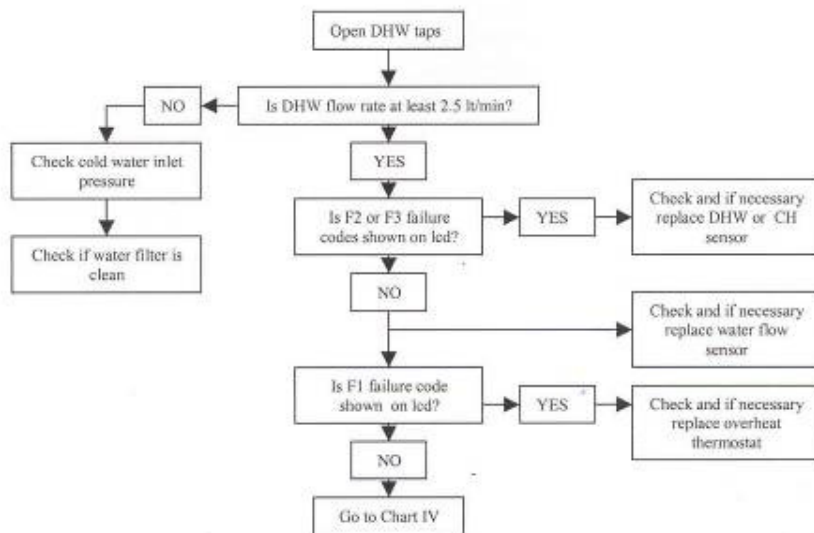
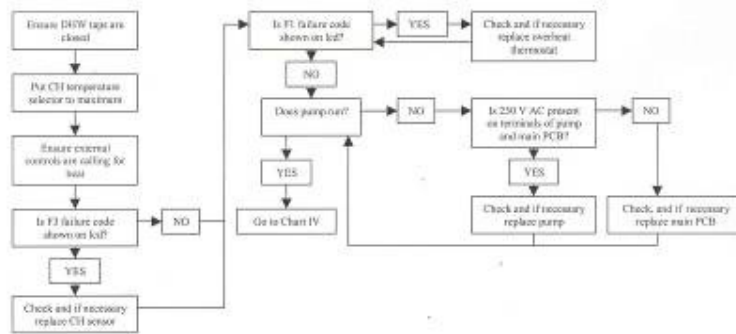

Chart II
Check Domestic Hot Water Operation



**Chart III
Check Central Heating Operation**



**Chart IV
Fan Operation**

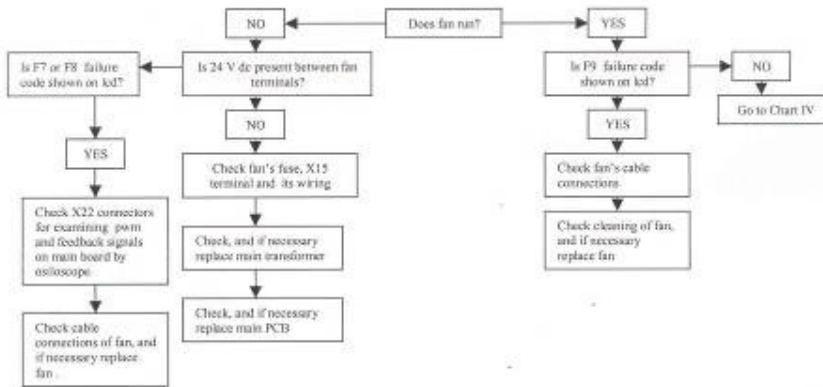

**Chart V
Check DHW and CH modulation**

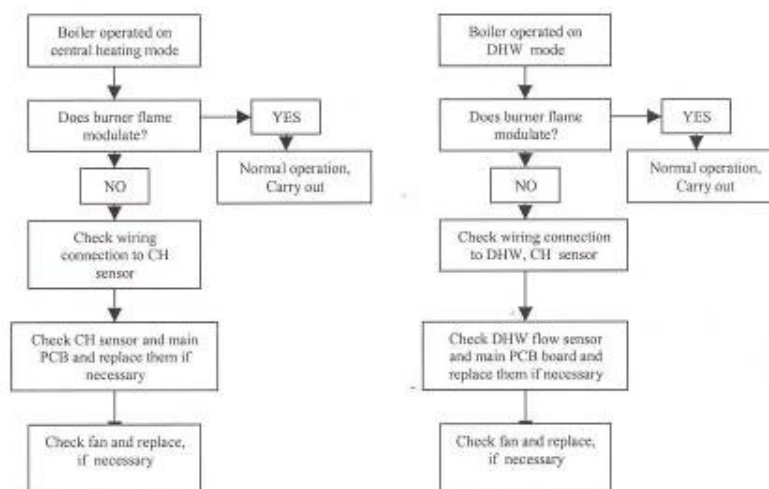
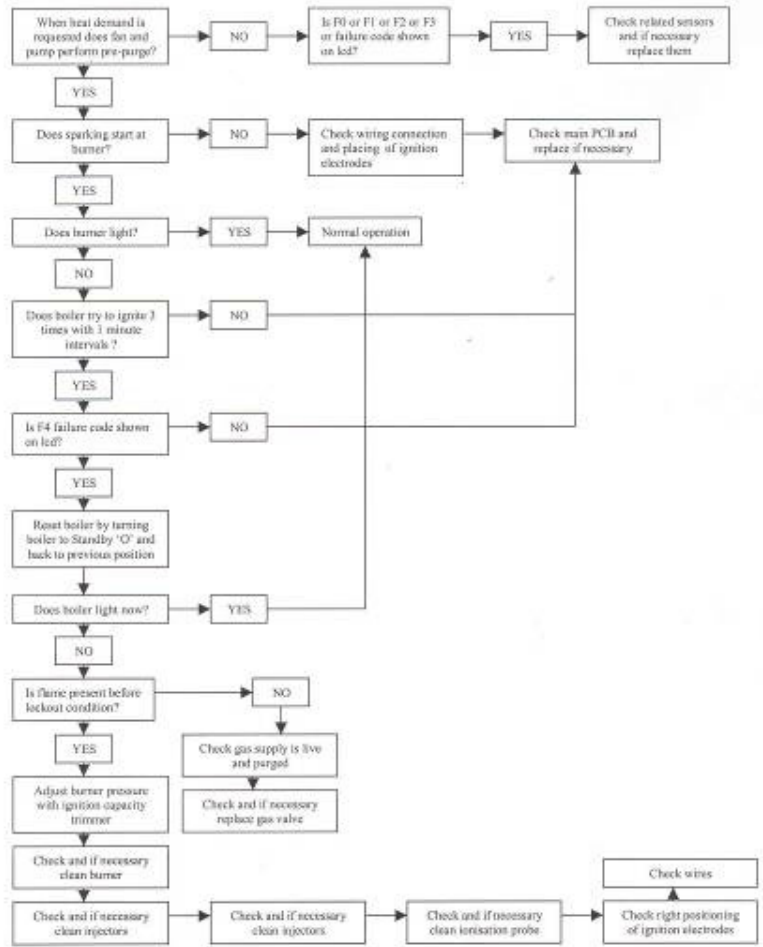

Chart VI
Check Ignition System



Appendix 1 Spare Parts List

APPENDICES

PART No.	DESCRIPTION	ORDER CODE
1	PRESSURE RELIEF VALVE	3003200019
2	PUMP ASSEMBLY	3003200022
3	EXPANSION VESSEL	3002209497
4	GAS VALVE	3003200657
5	AIR/GAS MIXER	3003200658
6	AIR/GAS MIXER RING (RED)	3003200659
7	PLASTIC DROP DOWN DOOR	
8	PCB BOX	3003200084
9	PCB MAIN CONTROL BOARD	3003200601
10	INTERFACE BOARD	3003200662
11	WIRING HARNESS WITH TIMER	3003200905
12	MAIN FLY LEAD	3003200915
13	PLATE HEAT EXCHANGER (30kW)	3003200780
14	PLATE HEAT EXCHANGER (24kW)	3003200897
15	DHW SENSOR (NTC)	3003200031
16	CH SENSOR (NTC)	3003200152
17	FLUE SENSOR	
18	FAN	3003200660
19	LIMIT THERMOSTAT	3003200397
20	MAIN TRANSFORMER	3003200661
21	SPARK GENERATOR	3003200663
22	IGNITION ELECTRODE WITH LEAD	3003200902
23	EARTH CABLE	3003200903
24	IONISATION ELECTRODE	3003200904
25	DIVERTER VALVE MOTOR (ONLY)	3003200039
26	FLOW SENSOR HOUSING	3003200018
27	DIVERTER VALVE	3003200017
28	FRONT PANEL	3003200928
29	CONDENSATE TRAP	3003200461



SOLARIS
24/30PC Pre-mix
Condensing
Wall Mounted
Combination Boiler

User Instructions



Natural Gas

Heatline Solaris 24PC/30PC Pre-mix Condensing
Combination Boiler

British Gas Service Listing

Solaris 24PC G.C.No 47-157-04
Solaris 30PC G.C.No 47-157-05



The Heat Line™ range of heating boiler are manufactured from high quality materials, enabling reliability and optimum performance.

Heat Line™ are committed to the continual development of their appliances to ensure their customers benefit from the latest advances in combustion technology and energy savings.

Notified Body IMQ 51BP2750
CE Directive 90/396/EEC
CE Directive 92/42/EEC

The manufacturer, in the continuous process to improve his products, reserves the right to modify the data expressed in the present documentation at any time and without prior notice.

The present documentation is an informative support and it cannot be considered as a contract towards third parties.

'Benchmark' Log Book, Boiler Registration & SEDBUK

As part of the industry-wide initiative the boiler comes complete with an Installation, Commissioning and Service Record Log Book. Please read the Log book carefully and in accordance with current legislation, complete all sections relevant to the appliance and installation. The details within the Log Book will be required in the event of any warranty work.

On completion the Log Book, which is found on pages 46 & 47 of the Installation manual, must be left with the end user and the relevant sections completed on each subsequent Service visit.

NOTE: You are also obliged to register the installation of this boiler with C.O.R.G.I. Should you wish to check the SEDBUK website for the rating of this boiler, search under DD HEATING or the boiler name and designation, e.g. SOLARIS 24PC.

For further information or advice (UK) contact Heatline™:

Service please call: 0870 777 8341
Spares please call: 0870 777 8402
Technical assistance please call: 0870 777 8318

IMPORTANT INFORMATION.

The Heat Line™ boiler is a high efficiency gas fired boiler and represents the highest level of technology found in today's gas boiler market.

In order to maintain peak efficiency along with optimum performance and reliability it is essential that the boiler be serviced at least once per year by a competent person such as a CORGI Registered Engineer.

All C.O.R.G.I. Registered Installers carry a C.O.R.G.I. ID card and have a registration number, which should be recorded and entered on your benchmark log book. You can check your Installer registration by contacting C.O.R.G.I. on 01256 372300

The boiler's **'Log Book'** must be completed at each Service visit.

GAS SAFETY (INSTALLATION AND USE) REGULATIONS

It is a legal requirement that all gas appliances must be installed and serviced by a competent or C.O.R.G.I. registered person in accordance with the above regulations. Failure to install or service gas appliances correctly may invalidate your guarantee and could lead to prosecution. It is in your interest and that of safety to ensure compliance with the law.

For electrical safety the boiler must be earthed and protected by a **5 -amp fuse**.

Note. In the event of a fault the appliance should not be used until a competent person has corrected the fault.

VENTILATION

For maintenance and safety purposes, the boiler has been installed with a minimum space of 200mm above, 300mm below, 600mm to the front and 20mm to either side of the boiler case. It is essential that this space is not restricted by the addition of shelves etc. fitted above or below the boiler, or to the

boiler sides. See section 6 for detail. Do not store flammable material or liquids near the boiler.

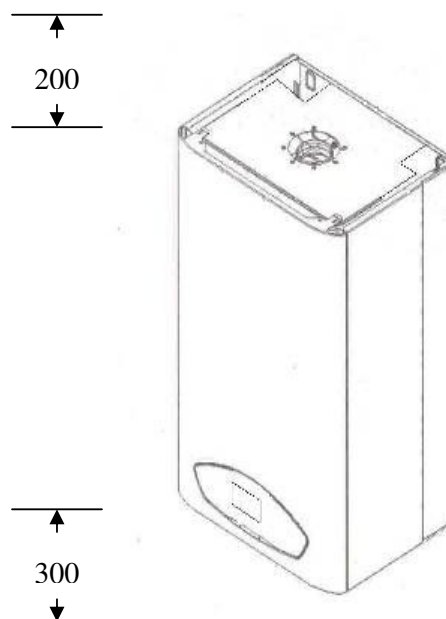

GENERAL DESCRIPTION OF THE BOILER

The boiler is a combined domestic hot water and central heating appliance. Its internal control unit electronically provides direct burner ignition and combustion supervision along with continuous modulation of the burner's gas supply.

By means of a manual switch the boiler can be set to operate in one of two operating modes, domestic hot water only or domestic hot water and central heating.

DOMESTIC HOT WATER MODE:

When hot water demand is requested, by the opening of a hot water faucet, the boiler will fire automatically. An integral pump is then energised and hot water from the boiler's primary circuit is circulated through the secondary heat exchanger, allowing the instantaneous transferral of heat to the incoming cold water. The secondary heat exchanger is protected against an internal build up of lime scale by limiting the hot water temperature at the tap to a maximum of 64°C. Hot water will continue to flow through the tap until no longer required. When the demand for hot water ceases the integral pump may continue to run for a short while to dissipate any excess heat

within the boiler.

DOMESTIC HOT WATER AND CENTRAL HEATING MODE:

When heating demand is requested the boiler will fire automatically. An integral pump is then energised and hot water from the boiler's primary circuit is circulated around the heating systems pipe-work and radiators. The heat output from the boiler is automatically adjusted by the boiler's internal control unit to match the heating demand. As the water temperature of the heating system increases the gas input to the burner decreases, conserving energy and increasing efficiency. When the demand for heating no longer exists, either the room thermostat is satisfied or the heating period has ended, the burner will shut down and the boiler will revert to stand-by, waiting to respond to the next heating demand. The integral pump may continue to run after shut down for a short while to dissipate any excess heat within the boiler.

Please Note. When domestic hot water is called for during the heating mode, the boiler will automatically revert to domestic hot water mode until the demand for hot water ceases.
NOTE: Depending on the boiler set up there may be a delay of 45secs before the boiler re-fires.





Figure 2



ACCESS TO THE BOILER CONTROLS

The boiler controls are found behind the control panel door, sited at the bottom of the boiler's front case. To open: press the doors retaining push catch just above the display screen. (figure 2)

BOILER CONTROLS

The function and operation of the main controls located on the control panel fascia (figure 3) is as follows:

1. **(Function switch.)** This is the boiler's main operating switch. In the  position the boiler is in stand-by mode and power supply is ON. For the boiler to operate the switch must be in the  or  position.

When switched to the  position the boiler will operate only to supply domestic hot water. (Summer use) For the boiler to operate to give both central heating and domestic hot water the switch must be in the  position. (Winter use)

2. **(Central Heating temperature control.)** The position of this control dial will determine the temperature of the water delivered to the radiators. The water temperature can be set from a minimum of 30° C (anticlockwise stop position) to a maximum of 85° C (clockwise stop position.)
3. **(D.H.W. temperature control)** The position of this control dial will determine the temperature of the domestic hot water delivered to the taps or shower unit. The water temperature can be set from a minimum of 35° C (anticlockwise stop position) to a maximum of 64° C (clockwise stop position.)

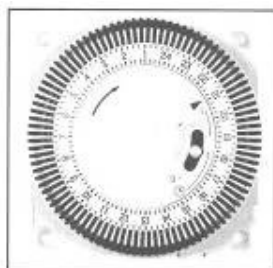

Figure 5

The operational time periods may be set as follows:

- ❑ Rotate the clock actuator mechanisms clockwise, by hand, until the small black triangle indicates the current time, see figure 5. In figure 5, current time is 21:05.
- ❑ The timer uses 24 hour format, e.g. the time for 1pm the time is 13:00 hrs.
- ❑ Select the "On" times by pushing the black tappets to the outside.
- ❑ Select the 'Off' times by pushing the black tappets towards the centre of the clock.

E.g. The clock shown in diagram 2 is set as follows:

The clock operation can be set by a selection switch.

The switch has 3 positions:

1 (Up) position: The boiler is controlled by the function switch (Item 1 in Figure 3) and allows continuous operation.

⌚ (Mid) position: The boiler heating circuit is controlled by both function switch and clock tappets, whilst hot water is delivered on demand.

0 (Down) position: The boiler is off, independent of the function switch.

FROST PROTECTION

The boiler has a built in frost protection device that protects the boiler from freezing. If the boiler is to be left and there is a risk of frost, ensure that the gas and electrical supplies are left connected. The frost protection device will light the boiler when the temperature of the boiler water falls below 6°C. When the

temperature reaches 15°C, the boiler will shut down.

Note: This device works irrespective of any room thermostat setting and will protect the boiler, but not necessarily the full system. Ensure that vulnerable sections of the circuit are adequately lagged.

ANTI PUMP SEIZURE

Note the pump will occasionally operate automatically in order to avoid seizure. See Daren for time specification

SYSTEM PRESSURE.

On installation your installer will have filled the boiler and system to its effective working pressure. The boiler's pressure sensor should be regularly checked on the LCD to ensure that this pressure is maintained between 1 and 2 bar. If there is a significant loss in pressure the boiler will lock out. The system may be re-charged by opening the filling loop to charge the system back up to 1.5bar as indicated on the LCD panel. **DO NOT OVERCHARGE THE BOILER PRESSURE BEYOND 2BAR AS THE BOILER WILL NOT OPERATE.** The filling loop, a flexible hose with two valves, should be located below the boiler connecting the second pipe from the right to either one of the outer pipes, see *figure 10 on page 19*. **DO NOT CLOSE ANY OF THE FOUR VALVES DIRECTLY CONNECTING TO THE BOILER.** If the boiler frequently loses pressure then your installer should be consulted.

OPERATING THE BOILER

Prior to operating the boiler, check that the pressure reading, on the LCD panel, lies between 1 and 2 bar.

Set the boiler's 'Central Heating' and 'Domestic Hot Water' temperature controls to maximum by turning fully clockwise and set the external 'Room Thermostat' (if fitted) to maximum. (To set the room thermostat refer to its manufacturer's instructions.)

Switch the boiler's functional switch to the  position. The boiler's integral control unit will now automatically carry out pre-ignition safety checks before finally igniting the burner.

The 'Central Heating' and 'Domestic Hot Water' temperature controls and 'Room Thermostat' can now be set to the desired temperature settings.

When a demand for heat no longer exists, the burner will automatically shut down but the green 'Boiler Stand by' indicator will remain alight.

The boiler will be ready for the next heating demand.

CLEANING

The boiler casing may be cleaned with a damp cloth followed by a dry cloth to polish. **Do not** use abrasive or solvent cleaners.

FURTHER ADVICE

For further information or advice (UK) contact Heatlin™:

Service please call: 0870 777 8341

Spares please call: 0870 777 8402

Technical assistance please call: 0870 777 8318

Or by E mail at our Web Site on www.heatline.co.uk

OPERATING THE BOILER

Prior to operating the boiler, check that the pressure reading, on the LCD panel, lies between 1 and 2 bar.

Set the boiler's 'Central Heating' and 'Domestic Hot Water' temperature controls to maximum by turning fully clockwise and set the external 'Room Thermostat' (if fitted) to maximum. (To set the room thermostat refer to its manufacturer's instructions.)

Switch the boiler's functional switch to the  position. The boiler's integral control unit will now automatically carry out pre-ignition safety checks before finally igniting the burner.

The 'Central Heating' and 'Domestic Hot Water' temperature controls and 'Room Thermostat' can now be set to the desired temperature settings.

When a demand for heat no longer exists, the burner will automatically shut down but the green 'Boiler Stand by' indicator will remain alight.

The boiler will be ready for the next heating demand.

CLEANING

The boiler casing may be cleaned with a damp cloth followed by a dry cloth to polish. **Do not** use abrasive or solvent cleaners.

FURTHER ADVICE

For further information or advice (UK) contact Heatlin™:

Service please call: 0870 777 8341

Spares please call: 0870 777 8402

Technical assistance please call: 0870 777 8318

Or by E mail at our Web Site on www.heatline.co.uk

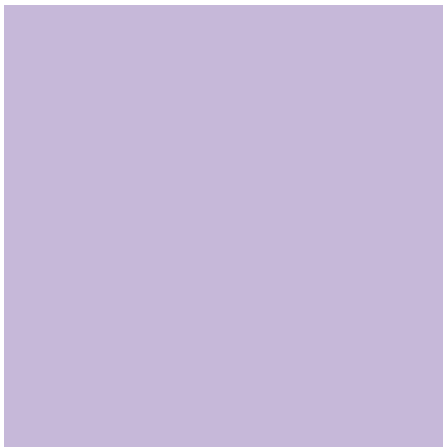

Heatline
Nottingham Road,
Belper,
Derbyshire,
DE56 1JT

Tel: 01773 596 099
Fax: 01773 828 123
Email: sales@heatline.co.uk