

+
USERS

INDEPENDENT
C24 C30 C35

For Installation Guide see reverse of book

When replacing any part on this appliance, use only spare parts that you can be assured conform to the safety and performance specification that we require. Do not use reconditioned or copy parts that have not been clearly authorised by Ideal.

For the very latest copy of literature for specification and maintenance practices visit our website www.idealboilers.com where you can download the relevant information in PDF format.

FOR ANY QUERIES PLEASE RING THE IDEAL CONSUMER HELPLINE : 01482 498660

NOTE. BOILER RESET PROCEDURE -

To reset boiler, turn mode control knob to reset position and immediately turn knob back to required setting.

Introduction

The **Independent** is a wall mounted, room sealed, condensing combination boiler, featuring full sequence automatic spark ignition and fan assisted combustion.

Due to the high efficiency of the boiler, condensate is produced from the flue gases and this is drained to a suitable disposal point through a plastic waste pipe at the base of the boiler. A condensate 'plume' will also be visible at the flue terminal.

The **Independent** is a combination boiler providing both central heating and instantaneous domestic hot water.

Safety

Current Gas Safety (Installation & Use)

Regulations or rules in force.

In your own interest, and that of safety, it is the law that this boiler must be installed by a Gas Safe Registered Engineer, in accordance with the above regulations.

In IE, the installation must be carried out by a Registered Gas Installer (RGII) and installed in accordance with the current edition of I.S. 813 "Domestic Gas Installations", the current Building Regulations and reference should be made to the current ETCI rules for electrical installation.

It is essential that the instructions in this booklet are strictly followed, for safe and economical operation of the boiler.

Electricity Supply

This appliance must be earthed.

Supply: 230 V ~ 50 Hz. The fusing should be 3A.

Important Notes

- This appliance must not be operated without the casing correctly fitted and forming an adequate seal.
- If the boiler is installed in a compartment then the compartment MUST NOT be used for storage purposes.
- If it is known or suspected that a fault exists on the boiler then it MUST NOT BE USED until the fault has been corrected by a Gas Safe Registered Engineer or in IE a Registered Gas Installer (RGII).
- Under NO circumstances should any of the sealed components on this appliance be used incorrectly or tampered with.
- This appliance is not intended for use by persons (including children) with reduced physical, sensory or mental capabilities, or lack of experience and knowledge, unless they have been given supervision or instructions concerning use of the appliance by a person responsible for their safety.
- Children should be supervised to ensure that they do not play with the appliance.

In cases of repeated or continuous shutdown a Gas Safe Registered Engineer or in IE a Registered Gas Installer (RGII) should be called to investigate and rectify the condition causing this and carry out an operational test. Only the manufacturers original parts should be used for replacement.

All Gas Safe Register installers carry a Gas Safe Register ID card, and have a registration number. Both should be recorded in the Benchmark Commissioning Checklist. You can check your installer by calling Gas Safe Register direct on 0800 4085500.

Ideal Stelrad Group is a member of the Benchmark scheme and fully supports the aims of the programme. Benchmark has been introduced to improve the standards of installation and commissioning of central heating systems in the UK and to encourage the regular servicing of all central heating systems to ensure safety and efficiency.

THE BENCHMARK SERVICE INTERVAL RECORD MUST BE COMPLETED AFTER EACH SERVICE

Minimum Clearances

Clearances of **165mm (6 1/2")** above, **100mm (4")** below, **2.5mm (1/8")** at the sides and **450mm (17 3/4")** at the front of the boiler casing must be allowed for servicing.

Bottom clearance

Bottom clearance after installation can be reduced to 5mm.

This must be obtained with an easily removable panel, to enable the consumer to view the system pressure gauge, and to provide the 100mm clearance required for servicing.

To light the boiler. Refer to Frame 1

1. CHECK THAT THE ELECTRICITY SUPPLY TO BOILER IS OFF.
2. Set the mains mode knob control (D) to 'Off'.
3. Set the Domestic Hot Water temperature control (B) and Central Heating temperature control (C) to 'max'.
4. Set the preheat control (A) to 'on'.
5. Ensure that all hot water taps are turned off.
6. Switch ON electricity to the boiler and check that all controls, e.g. timer and room thermostat, are ON (refer to mechanical timer instructions - Page 4).
7. Set the mode knob control to winter (☔ IIII).

The boiler will commence the ignition sequence, first supplying heat to preheat the domestic hot water and then to the central heating, if required.

Note. In normal operation the boiler status display (E) will show codes:

- D** Standby - no demand for heat.
- C** CH being supplied.
- D** DHW being supplied.
- P** DHW preheat.
- F** Boiler frost protection - boiler will fire if temperature is below 5 degrees C.

During normal operation the burner on indicator (F) will remain illuminated when the burner is lit.

Note: If the boiler fails to light after five attempts the fault code L-2 will be displayed.

RESET PROCEDURE

To reset boiler, turn the mode control knob (D) to reset position and immediately turn knob back to required setting. The boiler will repeat the ignition sequence. If the boiler still fails to light consult a Gas Safe Registered Engineer or in IE a Registered Gas Installer (RGII).



Operation

Winter conditions - i.e. CH and DHW required.

Ensure the mode knob control (D) is set to winter (☔)

The boiler will fire and supply heat to the radiators but will give priority to DHW on demand.

The DHW preheat will operate as described under 'Summer conditions' during periods when there is no call for CH.

Summer conditions - i.e. DHW only required.

Set the mode knob control to Summer (☀).

Set the CH external controls to OFF.

Preheat will operate with the preheat switch (A) set to ON.

The boiler will fire periodically for a few seconds to maintain the DHW calorifier in a preheated condition. The average time period between firing is 90 minutes. This may vary considerably due to the surrounding ambient temperature of the boiler. The boiler will fire whenever there is a demand for DHW.

The boiler preheat facility can be immobilised by turning the preheat switch (A) to OFF. This will stop the boiler operating for short periods. This facility is primarily provided for boiler installations in a sensitive area (i.e. bedroom etc.)

Note. The pump will operate briefly as a self-check once every 24 hours, regardless of system demand.

Control of water temperature

Domestic Hot Water

The DHW temperature is limited by the boiler controls to 64°C maximum at low draw-off rate, adjustable via the DHW temperature control (B).

Approx. flow temperatures for the boiler thermostat settings are:

Knob Setting	Flow Temperature
Minimum	40°C (104°F)
Maximum	64°C (147°F)

Due to system variations and seasonal temperature fluctuations DHW flow rates/temperature rise will vary, requiring adjustment at the draw off tap : the lower the rate the higher the temperature, and vice versa.

Central Heating

The boiler controls the central heating radiator temperature to a maximum of 80°C, adjustable via the CH temperature control (C).

The Independent is a high efficiency combination boiler which is most efficient when operating in condensing mode.

The boiler will operate in this mode if the CH temperature control (C) is set to the 'e' position (economy mode). This control should be set to maximum for very cold periods.

Weather Compensation

When the Weather Compensation option is fitted to the system then the CH Temperature Control (C) becomes a method of controlling room temperature. Turn the knob clockwise to increase room temperature and anti-clockwise to decrease room temperature. Once the desired setting has been achieved, leave the knob in this position and the system will automatically achieve the desired room temperature for all outside weather conditions.

To shut down the boiler

Set the mode knob control to OFF

To relight the boiler

Repeat the procedure detailed in 'To light the boiler'.

Frost protection

If no system frost protection is provided and frost is likely during a short absence from home, leave the heating controls (if fitted) at a reduced temperature setting. For longer periods, the entire system should be drained.

If the system includes a frost thermostat then, during cold weather, the boiler should be turned OFF at the time switch (if fitted) ONLY. The mains supply should be left switched ON, with the boiler thermostat left in the normal running position.

Boiler Overheat Protection

The boiler controls will shut down the boiler in the event of overheating. Should this occur, a fault code *L-1* will be displayed.

Refer to fault chart.

Flame Failure

Should this occur a fault code *F-2* will be displayed. Refer to fault chart.

continued

1 BOILER CONTROLS

Legend

- A. Pre-heat On/Off
- B. DHW Temperature Control
- C. CH Temperature Control
- D. Mode Control
- E. Boiler Status
- F. Burner 'on' Indicator
- G. Pressure Gauge
- H. Condensate Drain
- J. Economy Mode

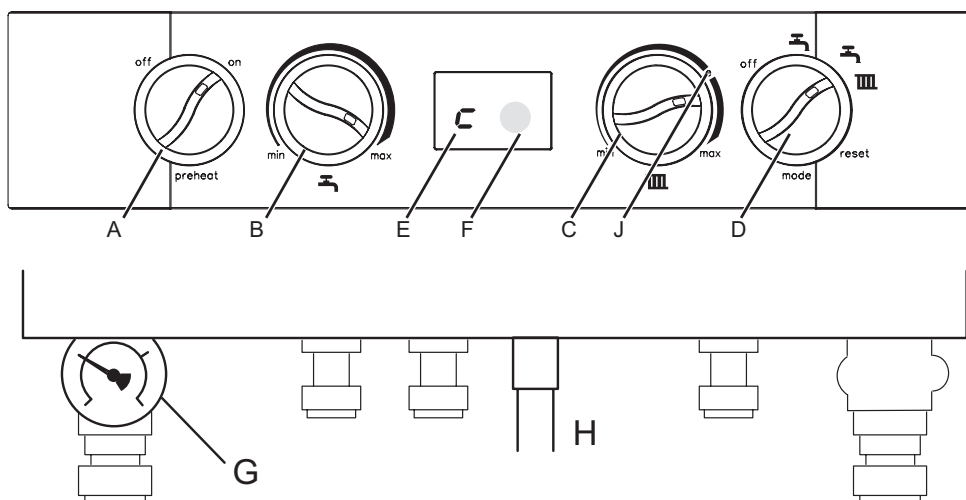

Loss of system water pressure

The gauge (G) indicates the central heating system pressure. If the pressure is seen to fall below the original installation pressure of 1-2 bar over a period of time then a water leak may be indicated. In this event the re-pressurise the boiler. If unable to do so or if the pressure continues to drop a Gas Safe Registered Engineer or in IE a Registered Gas Installer (RGII) should be consulted.

THE BOILER WILL NOT OPERATE IF THE PRESSURE HAS REDUCED TO LESS THAN 0.3 BAR UNDER THIS CONDITION.

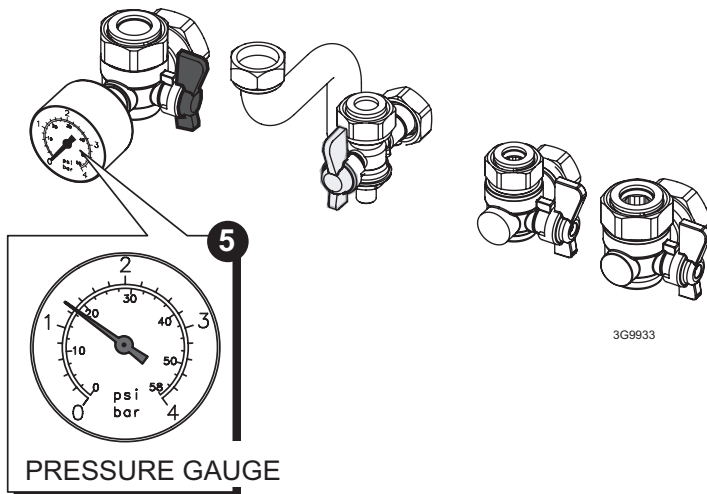

Condensate Drain

This appliance is fitted with a siphonic condensate trap system that reduces the risk of the appliance condensate from freezing. However should the condensate pipe to this appliance freeze, please follow these instructions:

- If you do not feel competent to carry out the defrosting instructions below please call your local Gas Safe Registered installer for assistance.
- If you do feel competent to carry out the following instructions please do so with care when handling hot utensils. Do not attempt to thaw pipework above ground level.

If this appliance develops a blockage in its condensate pipe, its condensate will build up to a point where it will make a gurgling noise prior to locking out an "L2" fault code. If the appliance is reset it will make a gurgling noise prior to it locking out on a failed ignition "L2" code.

To unblock a frozen condensate pipe;

- Follow the routing of the plastic pipe from its exit point on the appliance, through its route to its termination point. Locate the frozen blockage. It is likely that the pipe is frozen at the most exposed point external to the building or where there is some obstruction to flow. This could be at the open end of the pipe, at a bend or elbow, or where there is a dip in the pipe in which condensate can collect. The location of the blockage should be identified as closely as possible before taking further action.
- Apply a hot water bottle, microwaveable heat pack or a warm damp cloth to the frozen blockage area. Several applications may have to be made before it fully defrosts. Warm water can also be poured onto the pipe from a watering can or similar. **DO NOT** use boiling water.
- Caution when using warm water as this may freeze and cause other localised hazards.
- Once the blockage is removed and the condensate can flow freely, reset the appliance. (Refer to "To Light the boiler")
- If the appliance fails to ignite, call your Gas Safe Registered engineer.

Preventative solutions

During cold weather, set the boiler stat to maximum, (Must return to original setting once cold spell is over)

Place the heating on continuous and turn the room stat down to 15°C overnight or when unoccupied. (Return to normal after cold spell).

Escape of gas

Should a gas leak or fault be suspected contact the National Gas Emergency Service without delay. **Telephone 0800 111 999**

Do NOT search for gas leaks with a naked flame.

Cleaning

For normal cleaning simply dust with a dry cloth.

To remove stubborn marks and stains, wipe with a damp cloth and finish off with a dry cloth.

DO NOT use abrasive cleaning materials.

Maintenance

The appliance should be serviced at least once a year by a Gas Safe Registered Engineer or in IE a Registered Gas Installer (RGII).

MECHANICAL 24 HOUR TIMER

SETTING UP

The outer dial should be set to the current time. Rotate the dial slowly in a clockwise direction, until the correct hour is aligned with the arrow printed on the dial.

Note that the outer dial is printed with the 24hr clock e.g. 8.00am = 8 on the dial, 8.00pm = 20 on the dial.

Do not attempt to rotate the dial in an anti-clockwise direction.

PROGRAMMING SWITCHING TIMES

Set tappets to outer edge for ON periods and set tappets to inner edge for OFF periods.

The example shown has been set with 2 on periods.

ON at 9.00am. OFF at 1.00pm. (13 hours)

ON at 6.00pm. (18 hours) OFF at 10.00pm (22 hours)

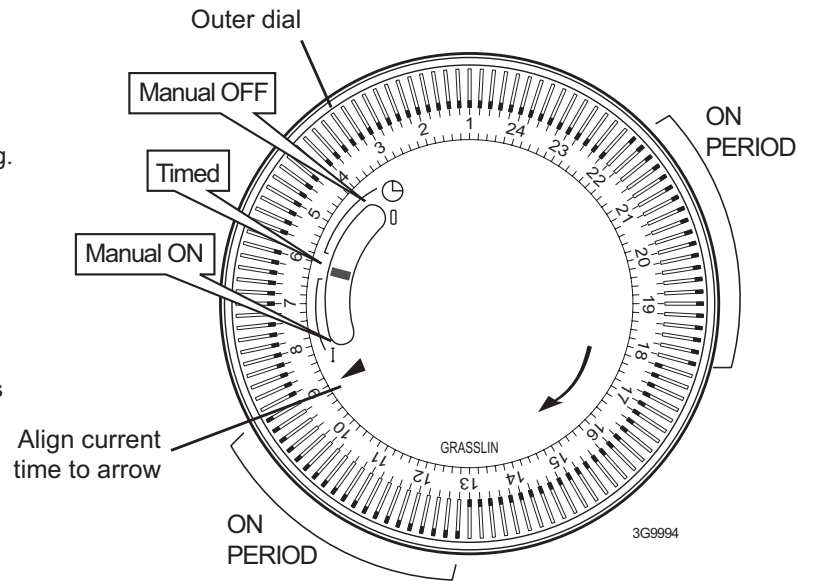

MANUAL SWITCH OPERATION

To set the timer for timed operation move the switch to the "TIMED" position.

To set the timer to be continuously on, move the switch to the "MANUAL ON" position.

To set the timer to be continuously off, move the switch to the "MANUAL OFF" position.

NOTE

If boiler does not light when in "timed on" or "manual on" position, increase temperature on room stat.





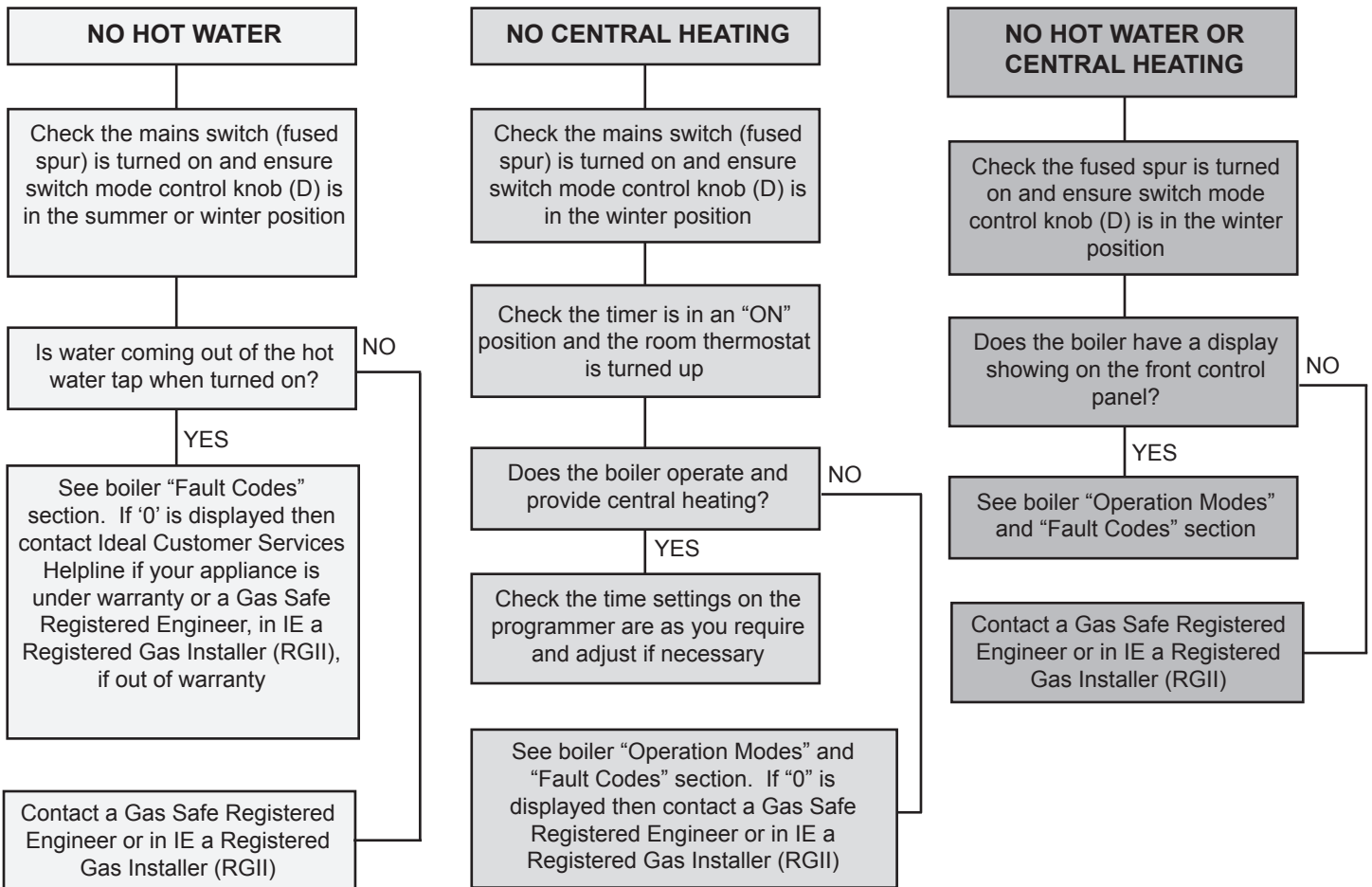

POINTS FOR THE BOILER USER

Note. In line with our current warranty policy we would ask that you check through the Troubleshooting guide to identify any problems external to the boiler prior to requesting a service engineers visit. Should the problem be found to be other than with the appliance we reserve the right to levy a charge for the visit, or for any pre-arranged visit where access is not gained by the engineer.

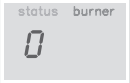
TROUBLESHOOTING











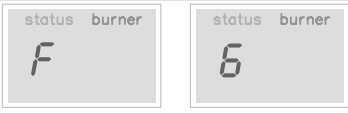

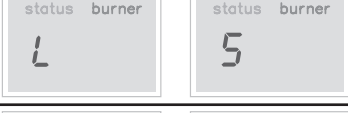
OPERATION MODES

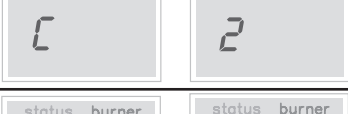
DISPLAY CODE ON BOILER	DESCRIPTION
	The boiler is in standby mode awaiting either a central heating call or hot water demand.
	The boiler has a call for central heating but the appliance has reached the desired temperature set on the boiler.
	The boiler has a call for hot water but the appliance has reached the desired temperature set on the boiler.
	The boiler is operating in central heating mode.
	The boiler is operating in hot water mode.
	The boiler is operating in pre heat mode.
	The boiler is operating in frost mode.

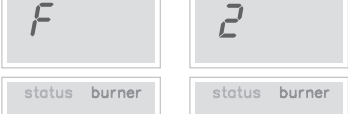
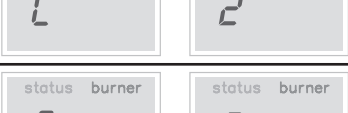
continued

FAULT CODES

DISPLAY CODE ON BOILER	DESCRIPTION	ACTION
	Outside Sensor Failure	Reset the appliance - if the boiler fails to operate then please contact Ideal (if under warranty) or alternatively a Gas Safe Registered Engineer if outside of the warranty period. In IE contact a Registered Gas Installer (RGII).
	Low Mains Voltage	Contact a qualified electrician or your electricity provider.
	Unconfigured PCB	Unconfigured PCB. Please contact Ideal (if under warranty) or alternatively a Gas Safe Registered Engineer if outside of the warranty period. In IE contact a Registered Gas Installer (RGII).
	5 Boiler Resets in 15 minutes	<ol style="list-style-type: none"> 1. Turn power off and on at the fused spur. 2. If the boiler fails to operate please contact Ideal (if under warranty) or alternatively a Gas Safe Registered Engineer if outside of the warranty period. In IE contact a Registered Gas Installer (RGII).
	False Flame Lockout	Reset the appliance - if the boiler fails to operate then please contact Ideal (if under warranty) or alternatively a Gas Safe Registered Engineer if outside of the warranty period. In IE contact a Registered Gas Installer (RGII).
	BCC Activation Fault	Reset the appliance - if the boiler fails to operate then please contact Ideal (if under warranty) or alternatively a Gas Safe Registered Engineer if outside of the warranty period. In IE contact a Registered Gas Installer (RGII).
	BCC Fault	
	Low Water Pressure	Check system pressure is between 1 & 1.5bar on the pressure gauge. If the boiler fails to operate then please contact Ideal (if under warranty) or alternatively a Gas Safe Registered Engineer if outside of the warranty period. In IE contact a Registered Gas Installer (RGII).
	Flow Temperature Overheat or Now Water Flow	
 	Flame Loss	<ol style="list-style-type: none"> 1. Check other gas appliances in the house are working to confirm a supply is present in the property. 2. If other appliances do not work or there are no other appliances, check the gas supply is on at the meter and/or pre payment meter has credit. If the boiler fails to operate then please contact Ideal (if under warranty) or alternatively a Gas Safe Registered Engineer if outside of the warranty period. In IE contact a Registered Gas Installer (RGII).
	Fan Fault	Reset the appliance - if the boiler fails to operate then please contact Ideal (if under warranty) or alternatively a Gas Safe Registered Engineer if outside of the warranty period. In IE contact a Registered Gas Installer (RGII).
	Flow Thermistor	Reset the appliance - if the boiler fails to operate then please contact Ideal (if under warranty) or alternatively a Gas Safe Registered Engineer if outside of the warranty period. In IE contact a Registered Gas Installer (RGII).
	Return Thermistor	Reset the appliance - if the boiler fails to operate then please contact Ideal (if under warranty) or alternatively a Gas Safe Registered Engineer if outside of the warranty period. In IE contact a Registered Gas Installer (RGII).