



USER GUIDE

Vogue Combi c26, c32, c40

When replacing any part on this appliance, use only spare parts that you can be assured conform to the safety and performance specification that we require.

Do not use reconditioned or copy parts that have not been clearly authorised by Ideal.

Vogue Combination boiler

Natural Gas only

c26	G.C. Appliance No. 47-348-99
c32	G.C. Appliance No. 47-348-98
c40	G.C. Appliance No. 47-348-97

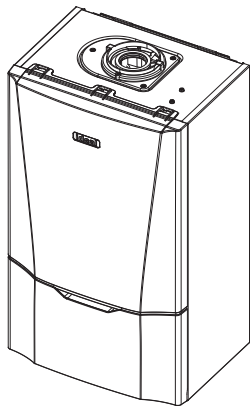

Ideal Stelrad Group is a member of the Benchmark scheme and fully supports the aims of the programme. Benchmark has been introduced to improve the standards of installation and commissioning of central heating systems in the UK and to encourage the regular servicing of all central heating systems to ensure safety and efficiency.



THE BENCHMARK SERVICE INTERVAL RECORD MUST BE COMPLETED AFTER EACH SERVICE

**FOR ANY QUERIES PLEASE RING THE
IDEAL CONSUMER HELPLINE : 01482 498660**

NOTE. BOILER RESET PROCEDURE -

To reset boiler, press button “r” on the control panel. The boiler will repeat the ignition sequence if a heat demand is present

INTRODUCTION

The **vogue** is a wall mounted, room sealed, condensing combination boiler, featuring full sequence automatic spark ignition and fan assisted combustion.

Due to the high efficiency of the boiler, condensate is produced from the flue gases and this is drained to a suitable disposal point through a plastic waste pipe at the base of the boiler. A condensate ‘plume’ will also be visible at the flue terminal.

The **vogue** is a combination boiler providing both central heating and instantaneous domestic hot water.

SAFETY

Current Gas Safety (Installation & Use) Regulations or rules in force.

In your own interest, and that of safety, it is the law that this boiler must be installed by a Gas Safe Registered Engineer, in accordance with the above regulations.

In IE, the installation must be carried out by a Registered Gas Installer (RGI) and installed in accordance with the current edition of I.S. 813 “Domestic Gas Installations”, the current Building Regulations and reference should be made to the current ETCI rules for electrical installation.

It is essential that the instructions in this booklet are strictly followed, for safe and economical operation of the boiler.

IMPORTANT NOTES

- This appliance must not be operated without the casing correctly fitted and forming an adequate seal.
- If the boiler is installed in a compartment then the compartment **MUST NOT** be used for storage purposes.
- If it is known or suspected that a fault exists on the boiler then it **MUST NOT BE USED** until the fault has been corrected by a Gas Safe Registered Engineer or in IE a Registered Gas Installer (RGII).
- Under **NO** circumstances should any of the sealed components on this appliance be used incorrectly or tampered with.
- This appliance is not intended for use by persons (including children) with reduced physical, sensory or mental capabilities, or lack of experience and knowledge, unless they have been given supervision or instructions concerning use of the appliance by a person responsible for their safety.
- Children should be supervised to ensure that they do not play with the appliance.

In cases of repeated or continuous shutdown a Gas Safe Registered Engineer or in IE a Registered Gas Installer (RGII) should be called to investigate and rectify the condition causing this and carry out an operational test. Only the manufacturers original parts should be used for replacement.

MINIMUM CLEARANCES

Clearances of **165mm (6 1/2")** above, **100mm (4")** below, **2.5mm (1/8")** at the sides and **450mm (17 3/4")** at the front of the boiler casing must be allowed for servicing.

Bottom clearance

Bottom clearance after installation can be reduced to 5mm.

This must be obtained with an easily removable panel to provide the 100mm clearance required for servicing.

BOILER CONTROLS

LEGEND

- A. Boiler Status
- B. Exit Button
- C. Down Button
- D. Up Button
- E. Enter Button
- F. Reset Button
- G. CH Temperature Control
- H. DHW Temperature Control and Off Switch
- J. Burner indication
- K. Pressure Gauge
- L. Boiler in Full Condensing Mode

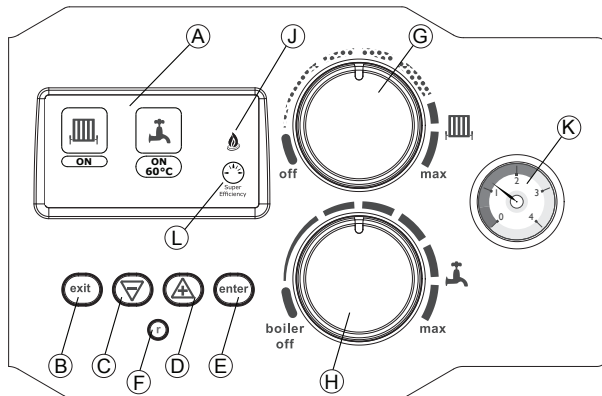

TO LIGHT THE BOILER. (REFER TO BOILER CONTROLS)

If a programmer is fitted refer to separate instructions for the programmer before continuing.

1. Switch ON electricity to the boiler and check that all external controls, e.g. programmer and room thermostat, are ON.
2. Set the Domestic Hot Water temperature control (H) and Central Heating temperature control (G) to 'max'.

The boiler will commence the ignition sequence supplying heat to the central heating, if required.

Note. *In normal operation the boiler status display (A) will display the boiler operation mode.*

Boiler frost protection - boiler will fire if temperature is less than 5 degrees C.

During normal operation the burner on indicator (J) will remain illuminated when the burner is lit.

If the boiler has not lit, after 5 ignition attempts, the following screen will be displayed.

Ignition Lockout

Check other Gas Appliances work
If not, re-instate gas supply
Reset boiler by pressing r
If fault persists contact installer

Reset the boiler and the ignition sequence will be repeated.

OPERATION

CH and DHW required.

The boiler will fire and supply heat to the radiators but will give priority to DHW on demand.

If required the DHW preheat will operate as described on page 17 MENU OPERATION - Preheat, during periods when there is no call for CH.

DHW only required.

Either set the heating control knob (G) to off - or,
Set the CH external controls to OFF.

Only if pre-heat is selected the boiler will fire periodically for a few seconds to maintain the DHW calorifier in a pre-heated condition. The average time period between firing is 90 minutes. This may vary considerably due to the surrounding ambient temperature of the boiler.

The boiler will fire whenever there is a demand for DHW.

The boiler preheat facility can be immobilised by selecting preheat OFF (see page 17 MENU OPERATION - Preheat). This will stop the boiler operating periodically for short periods. This facility is primarily provided for boiler installations in a sensitive area (i.e. bedroom etc.).

Note. *If the pump and diverter valve have not operated in the last 24 hours they will run briefly to ensure they do not become seized.*

CONTROL OF WATER TEMPERATURE

Domestic Hot Water

The DHW temperature is limited by the boiler controls to 65°C maximum at low draw-off rate, adjustable via the DHW temperature control (H).

Due to system variations and seasonal temperature fluctuations DHW flow rates/temperature rise will vary, requiring adjustment at the draw off tap : the lower the rate the higher the temperature, and vice versa.

Approx. hot water temperatures for the boiler thermostat settings are:

Knob Setting	Flow Temperature
Minimum	40°C (104°F)
Maximum	65°C (149°F)

Central Heating

The boiler controls the central heating radiator temperature to a maximum of 80°C, adjustable via the CH temperature control (G).

TO SHUT DOWN THE BOILER

Set the DHW temperature control knob to OFF.

TO RELIGHT THE BOILER

Repeat the procedure detailed in 'To light the boiler'. Set the DHW temperature control knob to between min & max.

FROST PROTECTION

If no frost protection is provided and frost is likely during a short absence from home, leave the heating controls (if fitted) at a reduced temperature setting. For longer periods, the entire system should be drained.

If the system includes a frost thermostat then the timer can be left off (if fitted). The mains supply should be left switched ON, with the boiler thermostat left in the normal running position.

BOILER OVERHEAT PROTECTION

The boiler controls will shut down the boiler in the event of overheating. Should this occur, the following display will appear:

Overheat Lockout

Fill System to 1 Bar

Bleed Radiators, Refill System

Check Radiator Valves are Open

Reset Boiler by pressing r

LOSS OF SYSTEM WATER PRESSURE

The gauge (K ref page 6) indicates the central heating system pressure. If the pressure is seen to fall below the original installation pressure of 1-2 bar then conduct the re-pressurising procedure as shown below. If unable to do so or if the pressure continues to drop a Gas Safe Registered Engineer or in IE a Registered Gas Installer (RGI) should be consulted.

THE BOILER WILL NOT OPERATE IF THE PRESSURE HAS REDUCED TO LESS THAN 0.3 BAR UNDER THIS CONDITION.

In this case the following display will appear:

Low Water Pressure

Fill System to 1 Bar
Bleed Radiators
Refill System to 1 Bar

To re-pressurise:

1. Ensure filling loop isolation valves are closed.
2. Remove the left hand caps.
3. Attach on the filling loop.
4. Turn the filling loop isolation valves to the open position.
The system will now fill.
5. Wait for pressure gauge to reach between 1 to 2 bar.
6. Close the filling loop isolation valves.
7. Disconnect the filling loop at left hand side and angle upwards.
8. Replace caps.

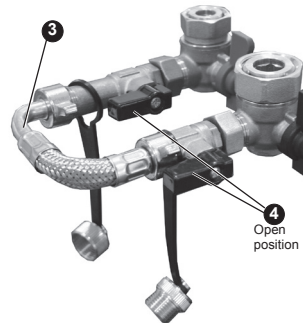
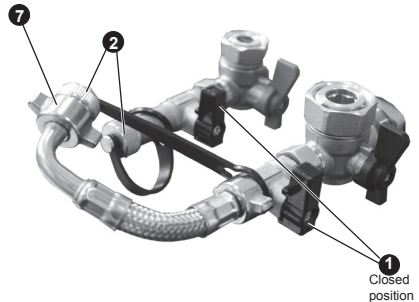

CONDENSATE DRAIN

This appliance is fitted with a siphonic condensate trap system that reduces the risk of the appliance condensate from freezing. However should the condensate pipe to this appliance freeze, please follow these instructions:

- a. If you do not feel competent to carry out the defrosting instructions below please call your local Gas Safe Registered installer for assistance.
- b. If you do feel competent to carry out the following instructions please do so with care when handling hot utensils. Do not attempt to thaw a condensate drain pipe if you cannot reach it from ground level. Be aware that any water used can quickly freeze if it falls onto pathways, causing a possible slip hazard. If this appliance develops a blockage in its condensate pipe, its condensate will build up to a point where the burner will go out:

Ignition Lockout

Check other Gas Appliances work
If not, re-instate gas supply
Reset Boiler by pressing r
If fault persists contact installer

If the appliance is reset it will not light prior to it locking out displaying the above on the display.

To unblock a frozen condensate pipe;

1. Follow the routing of the plastic pipe from its exit point on the appliance, through its route to its termination point. Locate the frozen blockage. It is likely that the pipe is frozen at the most exposed point external to the building or where there is some obstruction to flow. This could be at the open end of the pipe, at a bend or elbow, or where there is a dip in the pipe in which condensate can collect. The location of the blockage should be identified as

closely as possible before taking further action.

2. Apply a hot water bottle, microwaveable heat pack or a warm damp cloth to the frozen blockage area. Several applications may have to be made before it fully defrosts. Warm water can also be poured onto the pipe from a watering can or similar. DO NOT use boiling water.
3. Caution when using warm water as this may freeze and cause other localised hazards.
4. Once the blockage is removed and the condensate can flow freely, reset the appliance. (Refer to "To Light the boiler")
5. If the appliance fails to ignite, call your Gas Safe Registered engineer.

Preventative solutions

During cold weather, set the boiler stat to maximum, (Must return to original setting once cold spell is over)

Place the heating on continuous and turn the room stat down to 15°C overnight or when unoccupied. (Return to normal after cold spell).

ESCAPE OF GAS

Should a gas leak or fault be suspected contact the National Gas Emergency Service without delay. **Tel. 0800 111 999**

DO NOT SEARCH FOR GAS LEAKS WITH A NAKED FLAME.

CLEANING

For normal cleaning simply dust with a dry cloth. To remove stubborn marks and stains, wipe with a damp cloth and finish off with a dry cloth. DO NOT use abrasive cleaning materials.

MAINTENANCE

The appliance should be serviced at least once a year by a Gas Safe Registered Engineer or in IE a Registered Gas Installer (RGII).

POINTS FOR THE BOILER USER

Note. *In line with our current warranty policy we would ask that you check through the following guide to identify any problems external to the boiler prior to requesting a service engineers visit. Should the problem be found to be other than with the appliance we reserve the right to levy a charge for the visit, or for any pre-arranged visit where access is not gained by the engineer.*

FAULT FINDING

If a fault occurs then a fault description and suggested potential corrective actions will be displayed. In addition the following information may be useful.

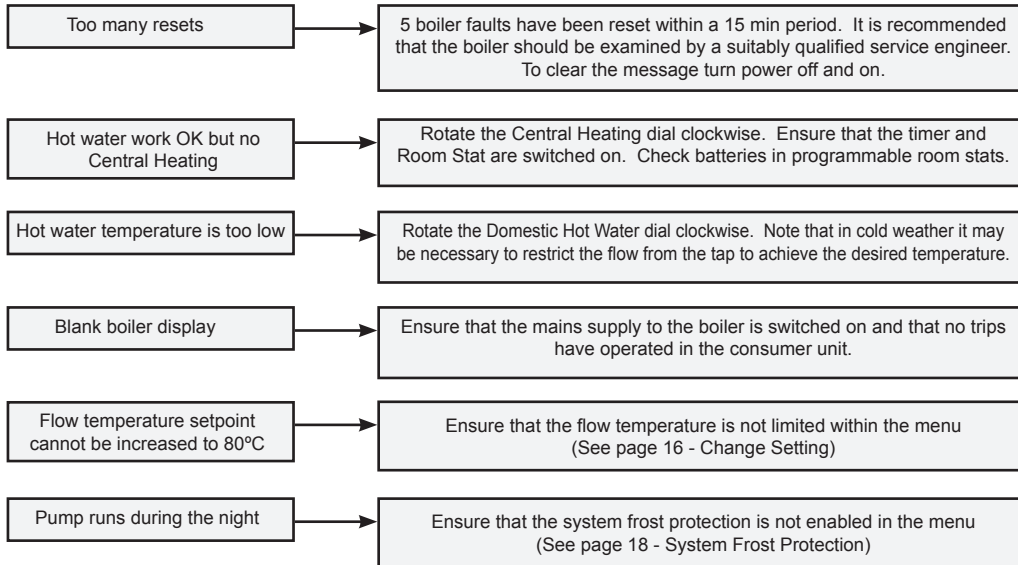







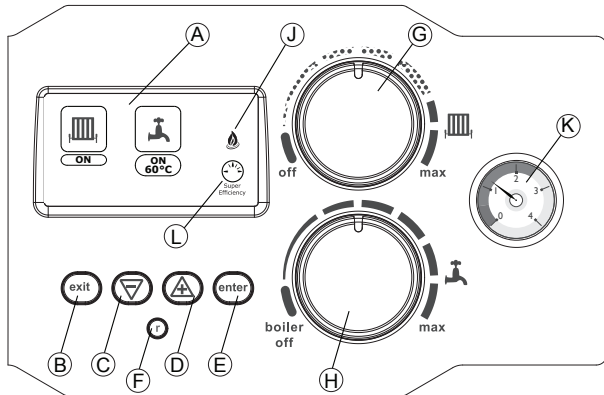



BOILER CONTROLS

LEGEND

- A. Boiler Status
- B. Exit Button
- C. Down Button
- D. Up Button
- E. Enter Button
- F. Reset Button
- G. CH Temperature Control
- H. DHW Temperature Control and Off Switch
- J. Burner On indication
- K. Pressure Gauge
- L. Boiler in Full Condensing Mode



1 DISPLAY FUNCTIONS IN NORMAL OPERATION

 <p>Indicates that the Boiler is Switched Off Move the DHW Dial (H) clockwise to switch the Boiler On</p> <p>OFF</p>	 <p>Indicates that the Boiler is providing Central Heating and that the radiator temperature is 60°C</p> <p>ON 60°C</p>
 <p>Indicates that Central Heating has been switched Off at the Boiler Move the CH Dial clockwise to switch Central Heating On at the Boiler</p> <p>OFF</p>	 <p>Indicates that the Boiler is pre-heating To Switch Pre-heat Off, see page 17 - Pre-heat</p> <p>Pre-Heat 50°C</p>
 <p>Indicates that all Taps and Showers are Off</p> <p>NO DEMAND</p>	 <p>Indicates that the temperature at the boiler is less than 5°C and that the boiler is running to protect itself from frost damage</p> <p>4°C</p>
 <p>Indicates that the Timer or Room Stat is switched Off</p> <p>NO DEMAND</p>	<p>Service Due Phone 01482 498704</p> <p>Indicates that a Service is due To Reset, see page 19 - Reset Service Time</p>
 <p>Indicates that the Boiler is providing Hot Water at 60°C</p> <p>ON 60°C</p>	  <p>Indicates that the pump is running as part of System Frost Protection because the Outside Temperature is less than 5°C. To disable refer to Page 18, System Frost Protection</p> <p>4°C</p>

2 CHANGE SETTING

To change the Hot Water Temperature rotate the DHW Dial
This screen will be shown

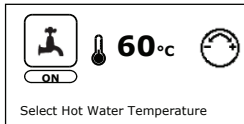

To disable DHW and CH (frost protection still active) rotate the DHW Dial fully anti-clockwise
This screen will be shown

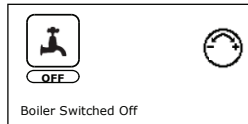

To change the Maximum Radiator Temperature rotate the CH Dial
This screen will be shown

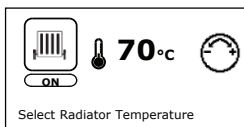

To switch the boiler On rotate the DHW Dial
This screen will be shown

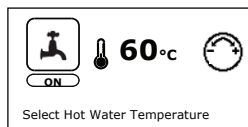

To switch the heating on, rotate the CH Dial clockwise.
This screen will be shown

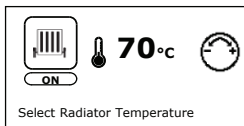

To change the Room Temperature Set Point (only if Outside Sensor connected) rotate the CH Dial
This screen will be shown

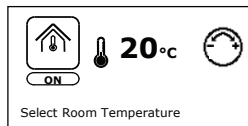

To switch the heating off, rotate the CH Dial fully anti-clockwise
This screen will be shown

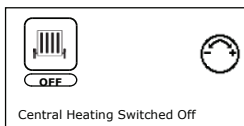

3 MENU OPERATION

Pre-heat

If pre-heat is switched on then the boiler will periodically fire the burner thereby reducing the time taken to provide hot water. If pre-heat is switched off the response time will be increased although gas consumption will also be reduced.

Press ENTER and the following screen will be displayed

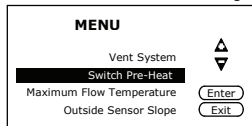

Press ENTER and a screen similar to the following will be displayed.

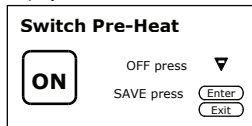

To switch Pre-heat off press “-“

To switch Pre-heat on press “+“

To return to normal operation press EXIT twice.

Efficiency Level

To view the efficiency level of the boiler press ENTER and the following screen will be displayed.

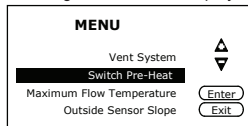

Press “-“ until the following screen is displayed.

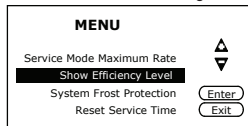

Press ENTER and a screen similar to following will be displayed.

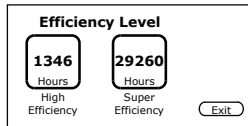

Press EXIT twice to return to normal operation.

4 MENU OPERATION

System Frost Protection

This feature can only be accessed if an outside sensor has been connected. The pump will run continuously if the outside temperature is less than 5°C.

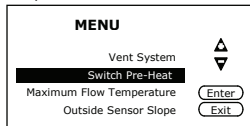

Press "-" until the following screen is displayed.

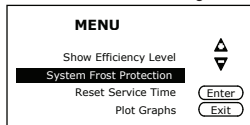

Press ENTER and a screen similar to the following will be displayed.



Press "+" to activate or "-" to de-activate.
Press EXIT twice to return to normal operation.

Reset Service Time

If the boiler has not been serviced within the last 12 months then a message will be displayed indicating this. To reset this timing proceed as follows.

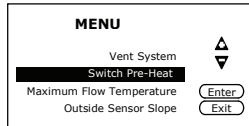

Press "-" until the following screen is displayed.

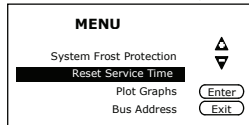

Press ENTER and the following screen will be displayed.

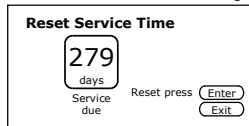

Press ENTER to reset.
Press EXIT to return to normal operation.

5 MENU OPERATION

Set Zone 2 Flow Temperature

If a second switched live is connected to the boiler for a second heating zone then the flow temperature target for this zone can be set independently. Press ENTER and the following screen will be displayed.

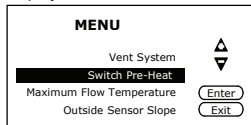

Press "-" until the following screen is displayed.

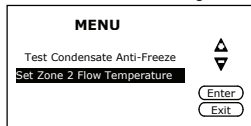

Press ENTER and the following screen will be displayed.

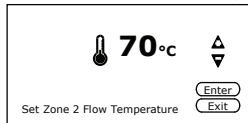

Press "+" & "-" to change the temperature to the require setting and then ENTER. Press EXIT to return to normal operation.

