

User Guide

Condensing Combination Boiler

Promax Combi

24 - 28 - 33

Please keep these instructions in a safe place.
If you move house, please hand them over to the next occupier.

Section	Page
1.0 Quick Reference Guide	3
2.0 Troubleshooting	4
3.0 Repressurising System	6
4.0 Clearances	7
5.0 Care of the Boiler	8
6.0 Legislation	9
7.0 Warranty & Service	10
8.0 ERP Information	12
9.0 Emergency	16
10.0 Disposal	16
11.0 Notes	17

Natural Gas

- Potterton Promax 24 Combi ErP
G.C.N° 47 393 47
- Potterton Promax 28 Combi ErP
G.C.N° 47 393 48
- Potterton Promax 33 Combi ErP
G.C.N° 47 393 49

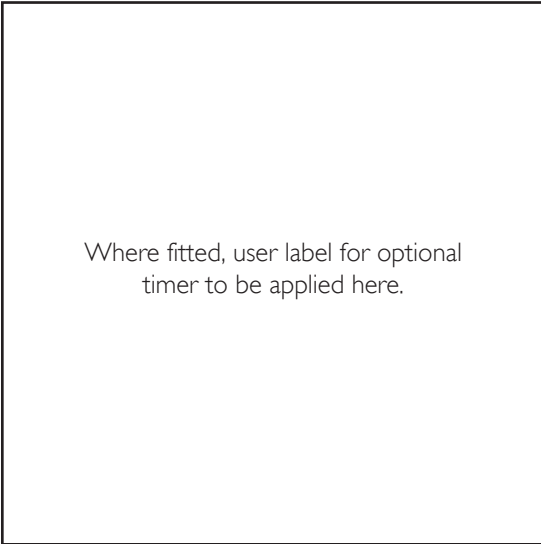

Where fitted, user label for optional timer to be applied here.

The Benchmark Scheme

Baxi Heating UK Ltd is a licensed member of the Benchmark Scheme which aims to improve the standards of installation and commissioning of domestic heating and hot water systems in the UK and to encourage regular servicing to optimise safety, efficiency and performance.

Benchmark is managed and promoted by the Heating and Hotwater Industry Council. For more information visit www.centralheating.co.uk

© Baxi Heating UK Ltd 2015 All rights reserved. No part of this publication may be reproduced or transmitted in any form or by any means, or stored in any retrieval system of any nature (including in any database), in each case whether electronic, mechanical, recording or otherwise, without the prior written permission of the copyright owner, except for permitted fair dealing under Copyrights, Designs and Patents Act 1988.

Applications for the copyright owner's permission to reproduce or make other use of any part of this publication should be made, giving details of the proposed use, to the following address:

The Company Secretary, Baxi Heating UK Ltd,
Brooks House, Coventry Road, Warwick. CV34 4LL

Full acknowledgement of author and source must be given.

WARNING: Any person who does any unauthorised act in relation to a copyright work may be liable to criminal prosecution and civil claims for damages.

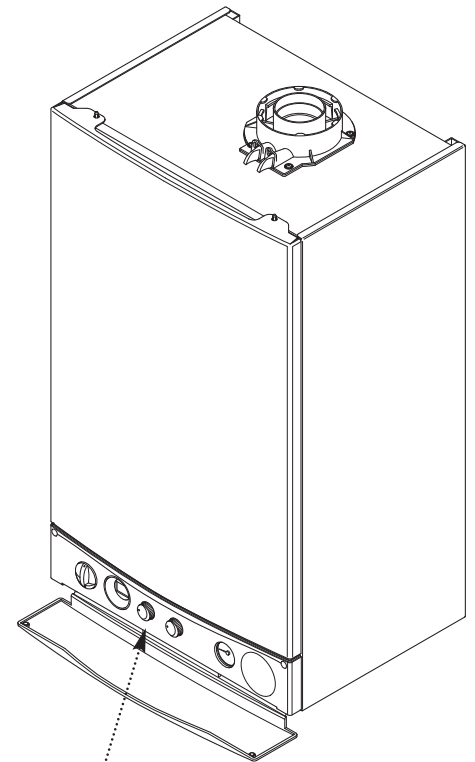

Boiler Controls - see opposite page for Operating Quick Reference Guide



ISO 9001
FM 00866

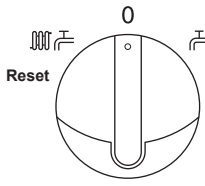

ON/OFF/Reset Selector Switch

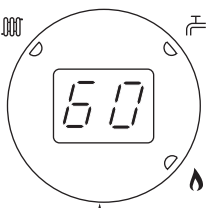

Display



Central Heating Temperature Control

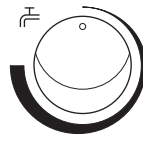

Domestic Hot Water Temperature Control

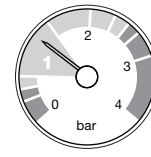

System Pressure Gauge

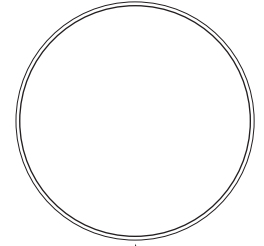

Position of Optional Timer

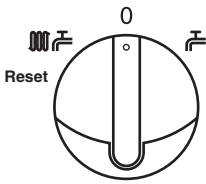

OFF Position
The boiler will not operate.

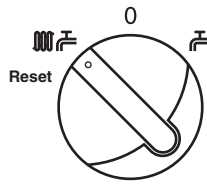

Central Heating & Hot Water
Both Heating & Hot Water will operate.

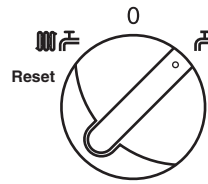

Domestic Hot Water
Hot Water will operate.

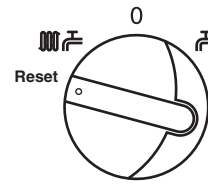

Reset
Hold for approx 5 seconds and release.

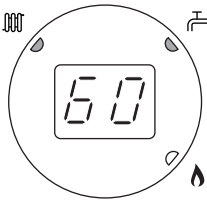

Display



Central Heating Indicator - The indicator will illuminate when the boiler is in the central heating mode.



Domestic Hot Water Indicator - The indicator will illuminate when hot water is being supplied to a tap or shower.



Burner On Indicator - The indicator will illuminate when the burner has fired and is heating your central heating or domestic hot water.

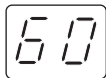

Boiler Output Temperature - In either the central heating or domestic hot water position the display will illuminate showing the current boiler temperature in degrees centigrade.

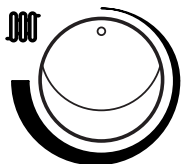

Central Heating Temperature Control

Turn the knob clockwise to increase or anticlockwise to decrease the temperature. Range 25 - 80° C.

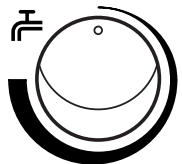

Domestic Hot Water Temperature Control

Turn the knob clockwise to increase or anticlockwise to decrease the temperature. Range 35 - 60° C.



Central Heating System Pressure - The normal operating water pressure is shown when the needle is in the GREEN section of the gauge, between 1 and 2.5 bar. If the pressure exceeds 3 bar (needle in the RED section) the safety pressure valve will operate and a fault is indicated. Contact your Installer.

Boiler not working

2.0 Troubleshooting

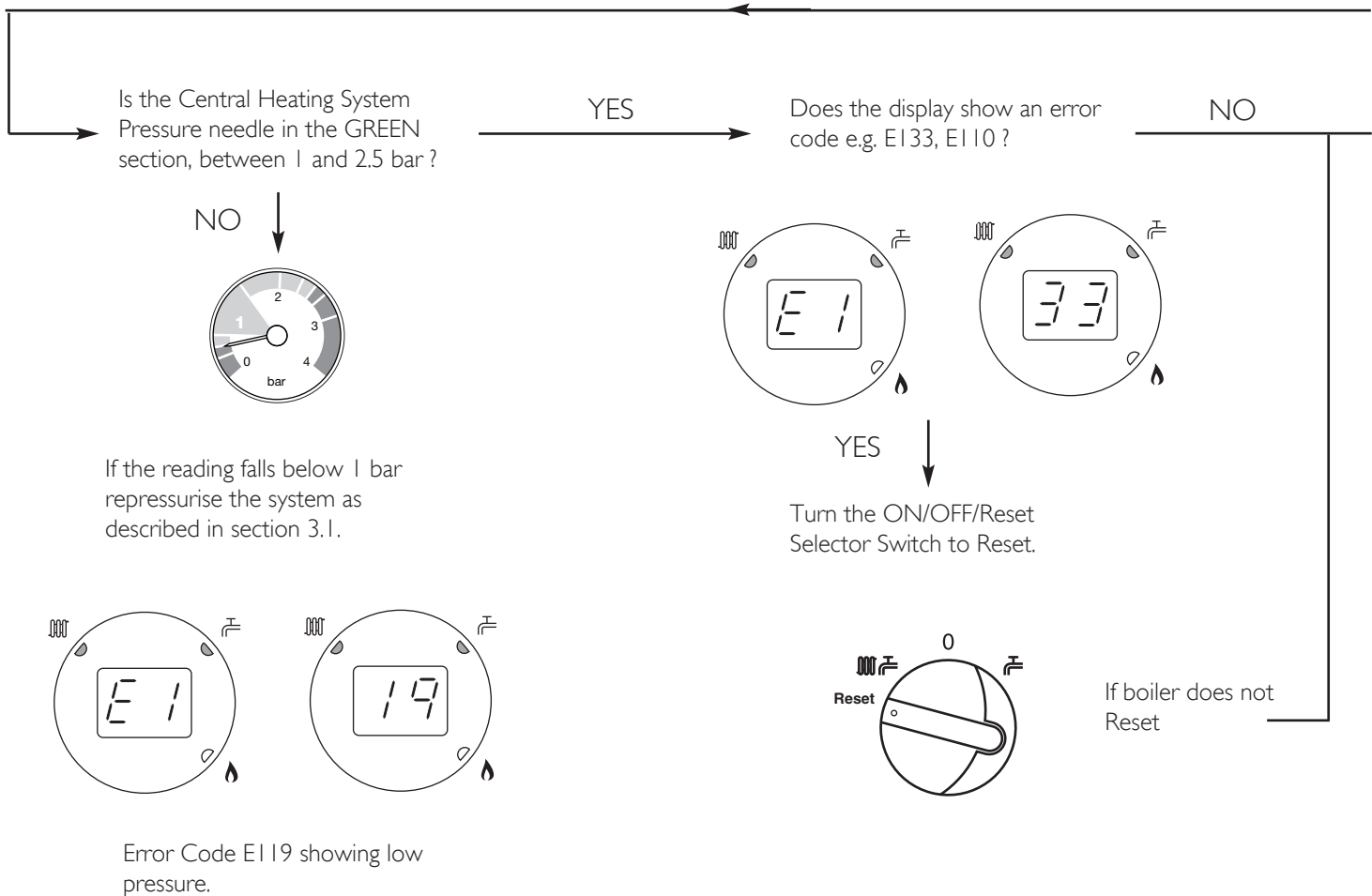
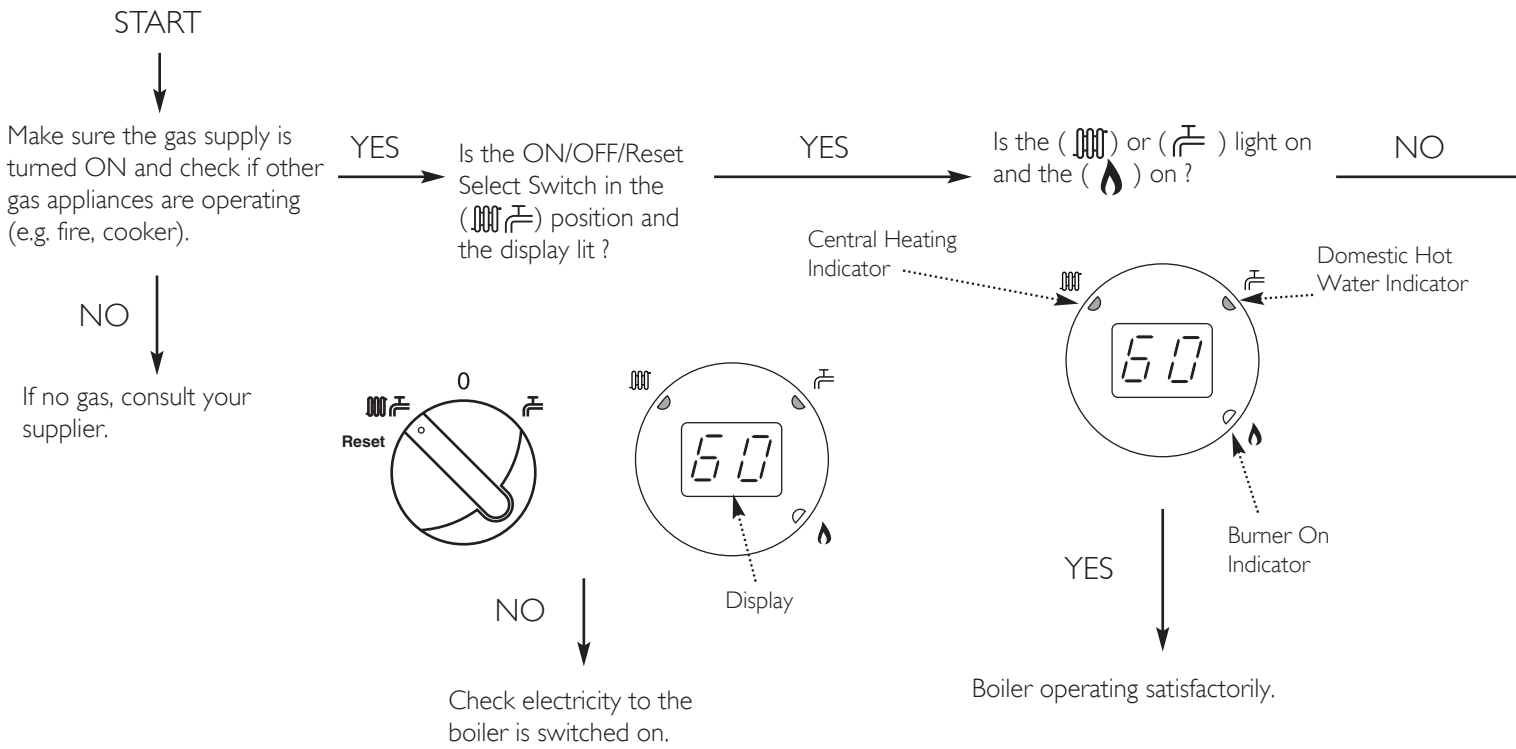

Is the Timer ON and calling for heat ?

YES

Is the Room Thermostat (if fitted) set high enough ?

YES

Typical examples of external timer

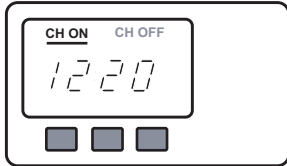
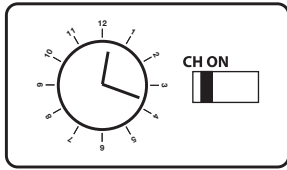

NO

Ensure timer is set for Central Heating ON (see any instructions supplied with timer).

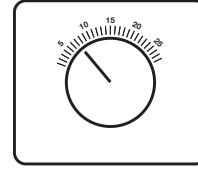

NO

Turn Room Thermostat to maximum setting (typical example shown).

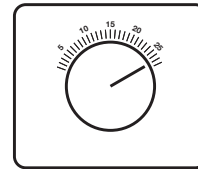

CONTACT YOUR INSTALLER OR SERVICE ENGINEER.

If you don't know what you need to do to get the boiler to light, or need help with the system and controls, contact your installer as soon as possible.

3.0 Re-pressurising System

3.1 Central Heating System Pressure

1. The water pressure in the central heating system is indicated by the pressure gauge.

2. With the system cold and the boiler not operating the pressure should be at least 0.5 bar. During operation the pressure should not exceed 2.5 bar, and will normally be between 1.0 and 1.5 (Fig. 1).

3. A pressure of 3 or greater indicates a fault. The safety pressure relief valve will operate, at a pressure of 3 (Fig. 3). **It is important that your Installer or Service Engineer is contacted as soon as possible.**

4. The minimum pressure for correct operation is 0.5. If the pressure falls below 0.5, this may indicate a leak on the central heating system (Fig. 2). Error Code E119 will be shown on the display.

3.2 To Re-Pressurise the System (Using Temporary Filling Loop)

1. It may be necessary to repressurise the system occasionally (when the water pressure falls below 0.5 bar). A filling device (filling loop) will be fitted on the system. This will be on the boiler itself if the device supplied with the boiler has been used, or on pipework near to the boiler if another device has been used.

2. If the water pressure requires regular re-pressurising a fault or leak is indicated (see section 3.1). Seek advice from your installer.

3. The filling loop supplied with the boiler consists of two blue handled isolating taps and a separate temporary filling pipe with connection fittings (Fig. 3b).

4. Looking underneath the right hand side of the boiler, ensure the two blue handled isolating taps are in the OFF position. Remove the Blanking Caps (Fig. 3a).

5. Fit the temporary Filling Loop Pipe, ensuring that the flanged washers are fitted to both ends of the pipe (Fig. 3b). Tighten the two wing nuts on the pipe to the taps.

6. Fully open one of the blue tap handles first, and then while watching the pressure gauge, carefully open the second blue tap handle (Fig. 3c).

7. When the needle on the pressure gauge indicates between 1 and 2 bar, turn both taps off.

8. The temporary filling loop pipe must be disconnected and completely removed after the system is pressurised. (Ensure the two blue handled isolating taps are in the OFF position before disconnecting.) Keep the pipe in a safe place.

9. Refit and hand tighten the blanking caps previously removed (Fig. 3a).

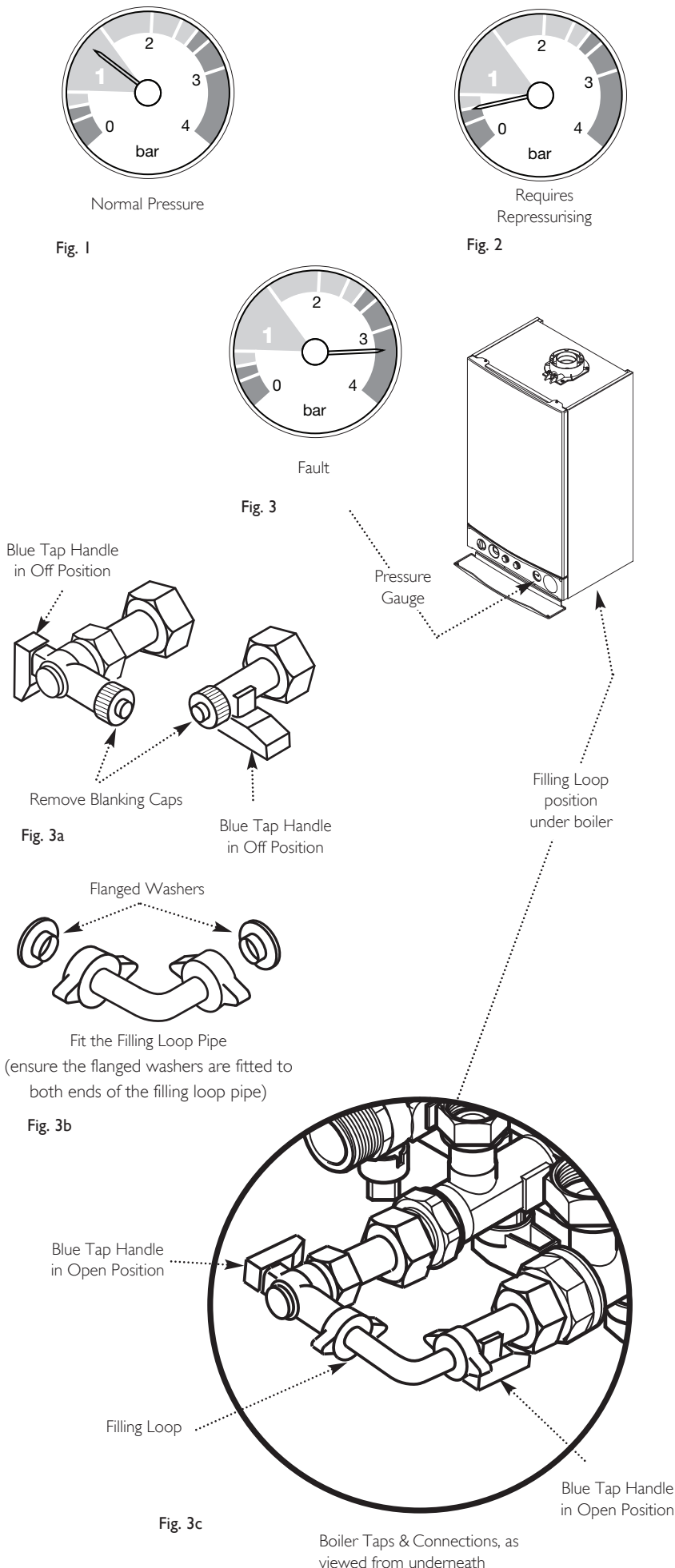

4.0 Clearances

4.1 For your Safety

NOTE: Only qualified persons are authorised to assemble, install and maintain the installation.

1. This appliance must have been installed in accordance with the manufacturer's instructions and the regulations in force.

2. Any modification that may interfere with the normal operation of the appliance without express written permission from the manufacturer or his agent could invalidate the appliance warranty. **In GB** this could also infringe the Gas Safety (Installation and Use) Regulations.

GB - Heating Industry definition meaning England, Scotland, Wales, Northern Ireland, Isle of Man and the Channel Isles

3. Your boiler must not be operated without the casing correctly fitted.

4. Do not interfere with any sealed components on this boiler.

5. Take note of any warning labels on your boiler.

6. Your boiler should have the following minimum clearances for Safety and Maintenance (Fig. 4):-

Top	- 200mm
Bottom	- 150mm
Left side	- 5mm
Right Side	- 5mm
Front	- 5mm (In Operation)
	- 450mm (For Servicing)

*This is the MINIMUM recommended dimension. Greater clearance than this will aid installation and maintenance.

7. If your boiler is installed in a compartment, do not use it for storage purposes. Do not obstruct any purpose provided ventilation openings.

8. Flammable materials must not be stored in close proximity to your boiler.

9. Avoid skin contact when your boiler is in operation, as some surfaces may get hot e.g. pipework.

10. Ensure that the flue terminal, outside the house, does not become damaged or obstructed, particularly by foliage.

11. It is important that the condensate drain system is not blocked, modified or damaged in any way as this would affect the operation of your boiler. Your installer should have insulated any exposed pipework.

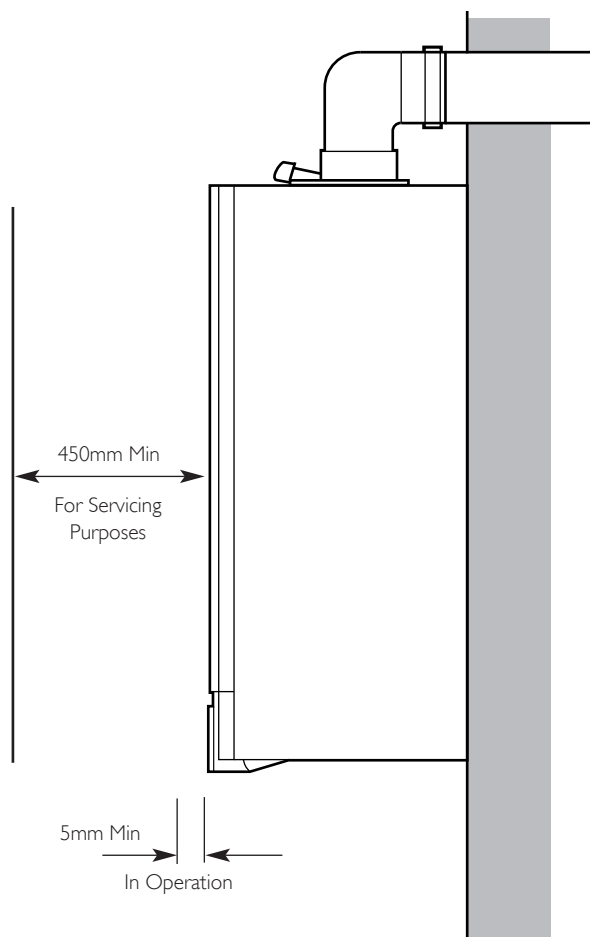
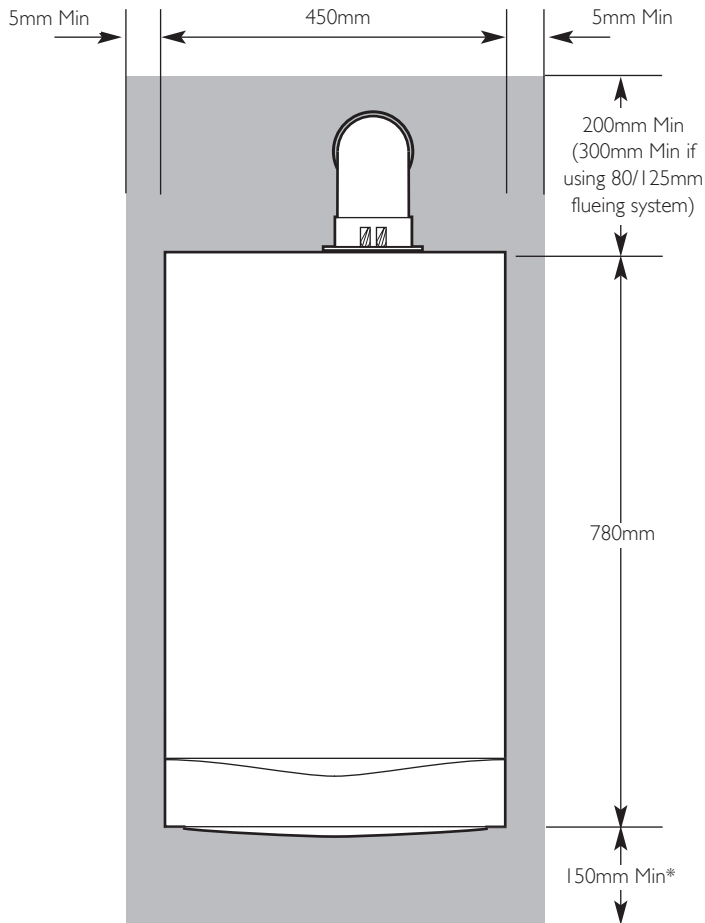

Fig. 4

5.0 Care of the Boiler

5.1 Cleaning the Outer case

The painted panels should be wiped with a damp cloth and then dried completely. **DO NOT USE ABRASIVE CLEANING AGENTS.**

5.2 Protection & Precaution

1. The boiler incorporates an integral frost protection feature that will operate in both modes. If the boiler temperature falls below 5° C, then the boiler will operate until the water temperature has been raised.
2. If a system frost thermostat has been fitted (your installer will be able to advise you), then to operate correctly and protect your system, the gas and electricity must be left on and the appliance set in the central heating mode.
3. The boiler incorporates an integral pump protection feature which continually monitors the time since the pump last operated. To prevent seizure, the pump will operate for approximately 1 minute if it has not run in the last 24 hours.

5.3 Fault Indication

1. If a fault occurs on the boiler an error code may be shown on the facia display (Fig. 5).
2. The codes are either two or three digit, preceded by the letter 'E'. For example, code E133 will be displayed by 'E1' alternating with '33'. E50 is shown as 'E' then '50'.
3. E20, E28, E50, E125 & E160 indicate faulty components. You should make a note of the displayed error code and contact your installer or service engineer. E28 may also indicate a blocked flue or condensate drain.
4. If E110 or E130 is displayed overheat of the primary water or flue system has occurred. Turn the selector switch to the reset position and hold for at least 5 seconds. If the boiler does not relight, or the code is displayed regularly contact your installer or service engineer.
5. E119 is displayed when the primary water pressure is less than 0,5 bar. After repressurising the system the boiler should operate. Your installer will be able to advise you about the method of repressurising. See page 6 for further details.
6. E133 indicates that the gas supply has been interrupted, ignition has failed or the flame has not been detected. Ensure that the gas supply has not been turned off, and turn the selector switch to the reset position and hold for at least 5 seconds. If the boiler does not relight, or the code is displayed regularly contact your installer or service engineer.

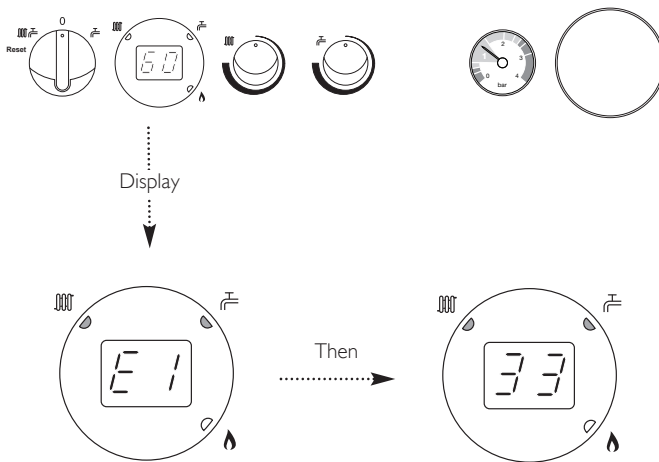

Fig. 5

Table Of Error Codes

E20	Central Heating NTC Fault
E28	Flue NTC Fault, Air Pressure Switch Fault, Blocked Flue, Blocked Condensate or Wiring Fault
E50	Hot Water NTC Fault
E110	Safety Thermostat Operated
E119	Water Pressure Switch Not Operated
E125	Circulation Fault (Primary Circuit)
E130	Flue NTC Operated
E133	Interruption Of Gas Supply or Flame Failure
E160	Fan or Fan Wiring Fault

6.0 Legislation

6.1 Installation, Commissioning, Service & Repair

1. This appliance must be installed in accordance with the manufacturer's instructions and the regulations in force. Read the instructions fully before installing or using the appliance.
2. In GB, this must be carried out by a competent person as stated in the Gas Safety (Installation & Use) Regulations.
3. **Definition of competence:** A person who works for a Gas Safe registered company and holding current certificates in the relevant ACS modules, is deemed competent.
4. In IE (Eire), this must be carried out by a competent person as stated in I.S. 813 "Domestic Gas Installations".

All Gas Safe registered engineers carry an ID card with their licence number and a photograph. You can check your engineer is registered by telephoning 0800 408 5500 or online at www.gassaferegister.co.uk

The boiler meets the requirements of Statutory Instrument "The Boiler (Efficiency) Regulations 1993 No 3083" and is deemed to meet the requirements of Directive 92/42/EEC on the energy efficiency requirements for new hot water boilers fired with liquid or gaseous fuels:-

Type test for purpose of Regulation 5 certified by:
Notified Body 0085.

Product/Production certified by:
Notified Bodies 0086.

For GB/IE only.

6.2 Benchmark Commissioning Checklist

1. Please ensure that the installer has fully completed the Benchmark Checklist on the inside back pages of the installation instructions supplied with the product and that you have signed it to say that you have received a full and clear explanation of its operation. The installer is legally required to complete a commissioning checklist as a means of complying with the appropriate Building Regulations (England and Wales).
 2. All installations must be notified to Local Area Building Control either directly or through a Competent Persons Scheme. A Building Regulations Compliance Certificate will then be issued to the customer who should, on receipt, write the Notification Number on the Benchmark Checklist.
 3. This product should be serviced regularly to optimise its safety, efficiency and performance. The service engineer should complete the relevant Service Record on the Benchmark Checklist after each service.
 4. The Benchmark Checklist may be required in the event of any warranty work.
-

7.0 Warranty & Service

7.1 General

To make sure your boiler warranty is activated and maintained, it is essential that the:

1. Benchmark checklist is completed by your installer
2. Warranty is registered with Baxi
3. Boiler has an annual service

Please note that failure to adhere to terms and conditions will make your warranty invalid.

7.2 Standard Warranty Terms and Conditions

Warranty Registration, Service & Repair

For full terms and conditions, visit www.baxi.co.uk/terms.

Benchmark Checklist

The Benchmark Checklist will be completed by your installer and records that the boiler has been installed and commissioned correctly. It can be found at the back of the installation and service manual and should be kept in a safe place for the life of the boiler. We will check that the Benchmark Checklist has been completed on an in-warranty visit.

Ways to register your warranty

If your boiler is eligible for an extended warranty, your installer may register the product on your behalf and provide you with the relevant documentation. Please check with your installer.

Should this not be the case, you can register your warranty online at www.baxi.co.uk/registration

To activate a **standard two year warranty**, please use one of the following methods:

- Freephone 0800 013 7989 or
 - Return the enclosed registration card
-

7.0 Warranty & Service

Annual Service

A service must be completed every 12 months from the date of installation to maintain your warranty.

This service must be completed by one of the following:

- A Gas Safe registered installer/engineer
- Baxi Customer Support; call us 0344 871 1525

Please make sure that your engineer has logged the service information at the back of the installation and service manual. You will be asked for your service history on any in-warranty repair visit.

If you experience a problem with your boiler

For any in or out of warranty repair, Baxi Customer Support is on hand to help you. Call our award-winning team to arrange for one of our nationwide team of Gas Safe registered engineers to visit.

If your product is in warranty, everything is free of charge, subject to our warranty terms and conditions. If it is out of warranty, we can still help and offer a range of options you can choose from to suit your needs.

Contact Baxi Customer Support 0344 871 1525

Opening hours

Monday - Friday, 8.00am - 6.00pm

Weekends and Bank Holidays, 8.30am - 2.00pm

Please note calls may be recorded for training and monitoring purposes.

When contacting Baxi Customer Support, please have the following information to hand:

- Boiler serial number. This can be found on the appliance.
- Proof of purchase if you do not have the boiler serial number.

Please note that for in-warranty repairs, our engineers will ask to see your service history record, completed Benchmark Checklist and details of your installer. These can all be found in the installation and user manual.

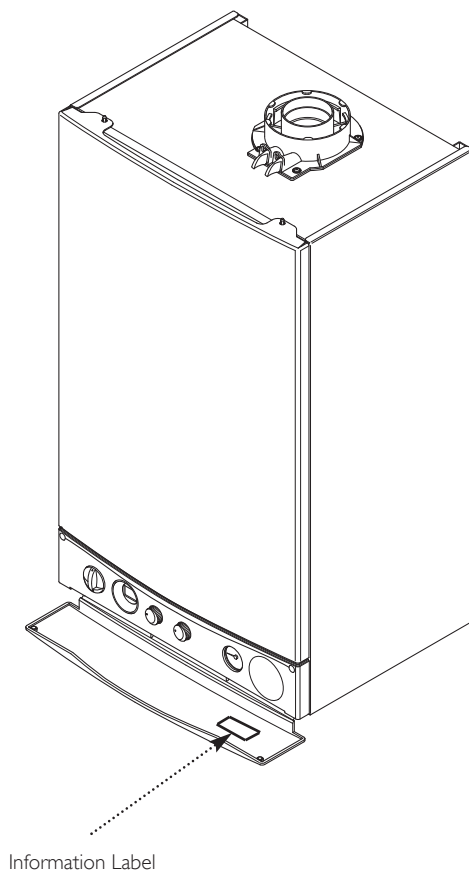

Information Label

Product fiche for combination boilers

Potterton Promax Combi ErP		24	28	33
Space heating - Temperature application		Medium	Medium	Medium
Water heating - Declared load profile		XL	XL	XL
Seasonal space heating energy efficiency class		A	A	A
Water heating energy efficiency class		A	A	A
Rated heat output (<i>Prated or Psup</i>)	kW	21	25	29
Space heating - Annual energy consumption	kWh GJ	17913 64	21478 77	25131 90
Water heating - Annual energy consumption	kWh GJ	18	18	18
Seasonal space heating energy efficiency	%	92	92	92
Water heating energy efficiency	%	84	81	83
Sound power level L_{WA} indoors	dB	50	53	52



See

For specific precautions about assembling, installing and maintaining, consult the relevant section as detailed on the Contents page.

8.2 Package Fiche - Boilers

Package fiche for boilers indicating the space heating energy efficiency of the package

Seasonal space heating energy efficiency of boiler

①
'I' %

Temperature control

from fiche of temperature control

Class I = 1%, Class II = 2%, Class III = 1.5%,
 Class IV = 2%, Class V = 3%, Class VI = 4%,
 Class VII = 3.5%, Class VIII = 5%

②
 + %

Supplementary boiler

from fiche of boiler

Seasonal space heating energy efficiency (in %)

③
 $(\text{ } - 'I') \times 0.1 = \pm \text{ }$ %

Solar contribution

from fiche of solar device

Collector size (in m²)

Tank volume (in m³)

Collector efficiency (in %)

Tank rating ⁽¹⁾
 A* = 0.95, A = 0.91,
 B = 0.86, C = 0.83,
 D - G = 0.81

④
 $(\text{'III'} \times \text{ } + \text{'IV'} \times \text{ }) \times 0.9 \times (\text{ } / 100) \times \text{ } = + \text{ }$ %

(1) If tank rating is above A, use 0.95

Supplementary heat pump

from fiche of heat pump

Seasonal space heating energy efficiency (in %)

⑤
 $(\text{ } - 'I') \times \text{'II'} = + \text{ }$ %

Solar contribution AND Supplementary heat pump

select smaller value

⑥
 $0.5 \times \text{ } \text{ OR } 0.5 \times \text{ } = - \text{ }$ %

Seasonal space heating energy efficiency of package

⑦
 %

Seasonal space heating energy efficiency class of package

<input type="checkbox"/>	<input type="checkbox"/>	<input type="checkbox"/>	<input type="checkbox"/>	<input type="checkbox"/>	<input type="checkbox"/>	<input type="checkbox"/>	<input type="checkbox"/>	<input type="checkbox"/>	<input type="checkbox"/>
G	F	E	D	C	B	A	A⁺	A⁺⁺	A⁺⁺⁺
<30%	≥30%	≥34%	≥36%	≥75%	≥82%	≥90%	≥98%	≥125%	≥150%

Boiler and supplementary heat pump installed with low temperature heat emitters at 35°C ?

from fiche of heat pump

⑦
 $\text{ } + (50 \times \text{'II'}) = \text{ }$ %

The energy efficiency of the package of products provided for in this fiche may not correspond to its actual energy efficiency once installed in a building, as this efficiency is influenced by further factors such as heat loss in the distribution system and the dimensioning of the products in relation to building size and characteristics.

AD-3000743-01

- I The value of the seasonal space heating energy efficiency of the preferential space heater, expressed in %.
- II The factor for weighting the heat output of preferential and supplementary heaters of a package as set out in the following table.

- III The value of the mathematical expression: $294/(11 \cdot \text{Prated})$, whereby 'Prated' is related to the preferential space heater.
- IV The value of the mathematical expression $115/(11 \cdot \text{Prated})$, whereby 'Prated' is related to the preferential space heater.

Weighting of boilers

Psup / (Prated + Psup) ⁽¹⁾⁽²⁾	II, package without hot water storage tank	II, package with hot water storage tank
0	0	0
0.1	0.3	0.37
0.2	0.55	0.70
0.3	0.75	0.85
0.4	0.85	0.94
0.5	0.95	0.98
0.6	0.98	1.00
≥ 0.7	1.00	1.00

(1) The intermediate values are calculated by linear interpolation between the two adjacent values.
 (2) Prated is related to the preferential space heater or combination heater.

Package efficiency

Potterton Promax Combi ErP		24	28	33
Temperature control X	%			
Temperature control Y	%			

8.3 Package Fiche - Combination Heaters (Boilers or Heat Pumps)

Package fiche for combination heaters (boilers or heat pumps) indicating the water heating energy efficiency of the package

Water heating energy efficiency of combination heater

①
 %

Declared load profile:

Solar contribution

from fiche of solar device

Auxiliary electricity

②
 $(1.1 \times 'I' - 10\%) \times 'II' - 'III' - 'I' = +$ %

Water heating energy efficiency of package under average climate

③
 %

Water heating energy efficiency class of package under average climate

		<input type="checkbox"/>	<input type="checkbox"/>	<input type="checkbox"/>	<input type="checkbox"/>	<input type="checkbox"/>	<input type="checkbox"/>	<input type="checkbox"/>	<input type="checkbox"/>	<input type="checkbox"/>
		G	F	E	D	C	B	A	A⁺	A⁺⁺
<input type="checkbox"/> M	<27%	≥27%	≥30%	≥33%	≥36%	≥39%	≥65%	≥100%	≥130%	≥163%
<input type="checkbox"/> L	<27%	≥27%	≥30%	≥34%	≥37%	≥50%	≥75%	≥115%	≥150%	≥188%
<input type="checkbox"/> XL	<27%	≥27%	≥30%	≥35%	≥38%	≥55%	≥80%	≥123%	≥160%	≥200%
<input type="checkbox"/> XXL	<28%	≥28%	≥32%	≥36%	≥40%	≥60%	≥85%	≥131%	≥170%	≥213%

Water heating energy efficiency under colder and warmer climate conditions

Colder: ^③ - 0.2 x ^② = %

Warmer: ^③ + 0.4 x ^② = %

The energy efficiency of the package of products provided for in this fiche may not correspond to its actual energy efficiency once installed in a building, as this efficiency is influenced by further factors such as heat loss in the distribution system and the dimensioning of the products in relation to building size and characteristics.

AD-3000747-01

- I The value of the water heating energy efficiency of the combination heater, expressed in %.
- II The value of the mathematical expression $(220 \cdot Q_{ref})/Q_{nonsol}$, where Q_{ref} is taken from Regulation EU 811/2013, Annex VII Table 15 and Q_{nonsol} from the product fiche of the solar device for the declared load profile M, L, XL or XXL of the combination heater.
- III The value of the mathematical expression $(Q_{aux} \cdot 2,5)/(220 \cdot Q_{ref})$, expressed in %, where Q_{aux} is taken from the product fiche of the solar device and Q_{ref} from Regulation EU 811/2013, Annex VII Table 15 for the declared load profile M, L, XL or XXL.

Warning !

If you smell gas

- Do not operate light switches
- Do not operate any electrical equipment
- Do not use a telephone in the hazardous area
- Extinguish any naked flame and do not smoke
- Open windows and doors in the hazardous area
- Turn off the gas supply at the meter
- Warn any other occupants and vacate the premises
- Telephone the National Gas Emergency Service on:-
0800 111 999

Faulty boiler

If it is known or suspected that a fault exists on the boiler, it must not be used until the fault has been corrected by a competent person.

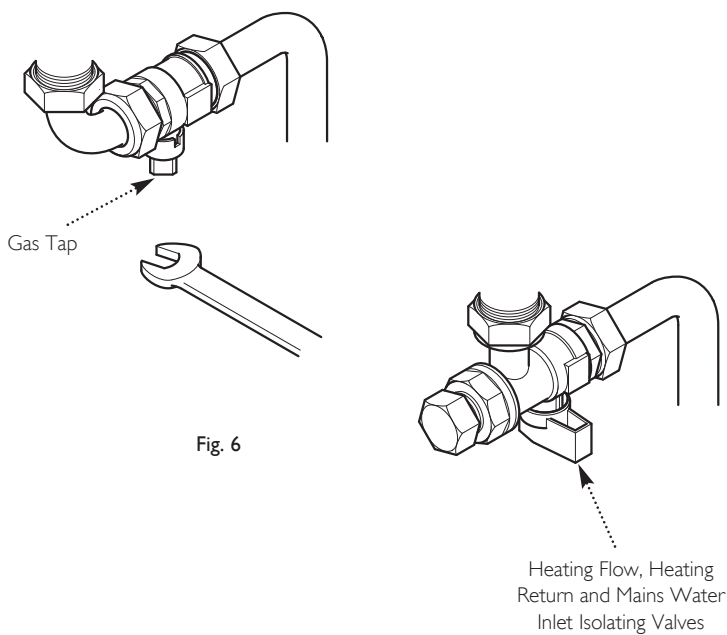

In an Emergency

If a water or gas leak occurs or is suspected, the boiler can be isolated at the inlet valves as follows;

1. Using a suitable open ended spanner, turn the square nut on the gas tap through 90° (1/4 turn) to isolate the gas supply at the boiler (Fig. 6).
3. The water isolating valves are positioned under the boiler and can be closed by turning their taps to the right towards the wall (Fig. 6).
4. Call your Installer or Service Engineer as soon as possible.

10.0 Disposal

10.1 Disposal and Recycling

NOTE: Removal and disposal of the boiler must be carried out by a qualified person in accordance with local and national regulations.

Baxi Customer Support



0344 871 1525

Opening hours

Monday - Friday, 8.00am-6.00pm

Weekends and Bank Holidays, 8.30am-2.00pm

Please note calls may be recorded for training and monitoring purposes



baxi.co.uk

Register now to activate your warranty:

www.baxi.co.uk/registration

For the warranty to be maintained, please make sure...

- 1** Benchmark checklist is completed
- 2** Warranty is registered with Baxi
- 3** The boiler has an annual service

For full terms and conditions, visit www.baxi.co.uk/terms. Failure to adhere to terms and conditions will void your manufacturer's warranty.



Baxi
Brooks House,
Coventry Road,
Warwick, CV34 4LL



Please ensure the boiler is installed in accordance with these installation instructions and that you adhere to the Building Regulations.

e&oe

All descriptions and illustrations provided in this document have been carefully prepared but we reserve the right to make changes and improvements in our products which may affect the accuracy of the information contained in this leaflet. All goods are sold subject to our standard Conditions of Sale which are available on request.

CE
0086



part of **BAXI**