

Sirius FS 50-70

Floor Standing Condensing Gas Boilers

Installation, Operation & Maintenance Manual



Working towards
a cleaner future

Dear Customer,

We are sure your new boiler will comply with all your requirements.

Do not dispose of this booklet. This manual contains the information, which will help you to run your boiler correctly and efficiently.

Do not leave any parts of the packaging (plastic bags, polystyrene, etc.) within children's reach as they are a potential source of danger.

POTTERTON COMMERCIAL boilers bear the CE mark in compliance with the basic requirements as laid down in the following Directives:

- Gas Directive 90/396/EEC
- Efficiency Directive 92/42/EEC
- Electromagnetic Compatibility Directive 2004/108/EEC
- Low Voltage Directive 2006/95/EC



ATTENTION

**This boiler can only be installed and operate
in permanently, ventilated rooms in accordance with
BS6644**

CONTENTS

INSTRUCTIONS PERTAINING TO THE USER

1. Instructions prior to installation	4
2. Instructions prior to commissioning	4
3. Commissioning of the boiler	5
4. Filling the boiler	12
5. Switching the boiler off	12
6. Prolonged standstill of the system. Frost protection	12
7. Servicing instructions and gas change	12

INSTRUCTIONS PERTAINING TO THE INSTALLER

8. General information	13
9. Instructions prior to installation	13
10. Boiler installation and dimensions	14
11. Chimney flue connection	21
12. Connecting the mains supply	23
13. Adjusting the gas valves and gas change	30
14. Setting the boiler parameters	32
15. Control and operation devices	34
16. Positioning of the ignition and flame sensing electrode	35
17. Check of combustion parameters	35
18. Activating the chimney-sweep function	36
19. Annual service	36
20. Boiler schematic	37
21. Illustrated wiring diagram	38
22. Technical data	39

1. INSTRUCTIONS PRIOR TO INSTALLATION

This boiler is designed to heat water at a lower than boiling temperature at atmospheric pressure. The boiler must be connected to a central heating system and/or to a domestic hot water supply system in compliance with its performances and output power.

The boiler must be installed by a Qualified Service Engineer and ensure the following operations are carried out:

- a) Check that the boiler is fit for operation with the type of gas available. For more details see the notice on the packaging and the label on the appliance itself.
- b) Careful checking that the flue terminal draft is appropriate; that the terminal is not obstructed and that no other appliance exhaust gases are expelled through the same flue duct, unless the flue is especially designed to collect the exhaust gas coming from more than one appliance, in conformity with the standards and regulations in force.
- c) Careful checking that, in case the flue has been connected to pre-existing flue ducts, thorough cleaning has been carried out in that residual combustion products may come off during operation of the boiler and obstruct the flue duct.
- d) To ensure correct operation of the appliance and avoid invalidating the warranty, observe the following precautions:

1. Heating circuit

1.1. New system

Before proceeding with installation of the boiler, the system must be cleaned and flushed out thoroughly to eliminate residual thread-cutting swarf, solder and solvents if any, using suitable proprietary products.

To avoid damaging metal, plastic and rubber parts, use only neutral cleaners, i.e. non-acid and non-alkaline. The recommended products for cleaning are:

SENTINEL X300 or X400 and FERNOX heating circuit restore. The use of this product must be strictly in accordance with the maker's directions. Finally the system must be dosed with a suitable inhibitor at 1% system volume.

1.2. Existing system

Before proceeding with installation of the boiler, the system must be cleaned and flushed out to remove sludge and contaminants, using suitable proprietary products as described in section 1.1.

To avoid damaging metal, plastic and rubber parts, use only neutral cleaners, i.e. non-acid and non-alkaline such as SENTINEL X100 and FERNOX heating circuit protective. To use this product proceed strictly in accordance with the maker's directions. Dose with inhibitor.

Remember that the presence of foreign matter in the heating system can adversely affect the operation of the boiler (e.g. overheating and noisy operation of the heat exchanger).

Failure to observe the above will render the warranty null and void.

2. INSTRUCTIONS PRIOR TO COMMISSIONING

Initial lighting of the boiler must be carried out by a qualified service engineer. Ensure the following operations are carried out:

- a) compliance of boiler parameters with (electricity, water, gas) supply systems settings.
- b) compliance of installation with the standards and regulations in force.
- c) appropriate connection to the power supply and earthing of the appliance.

Failure to observe the above will render the warranty null and void.

3. COMMISSIONING OF THE BOILER

To correctly light the burner proceed as follows:

- 1) Provide power supply to the boiler;
- 2) Open the gas cock;
- 3) Follow the directions given below regarding the adjustments to be made at the boiler control panel.

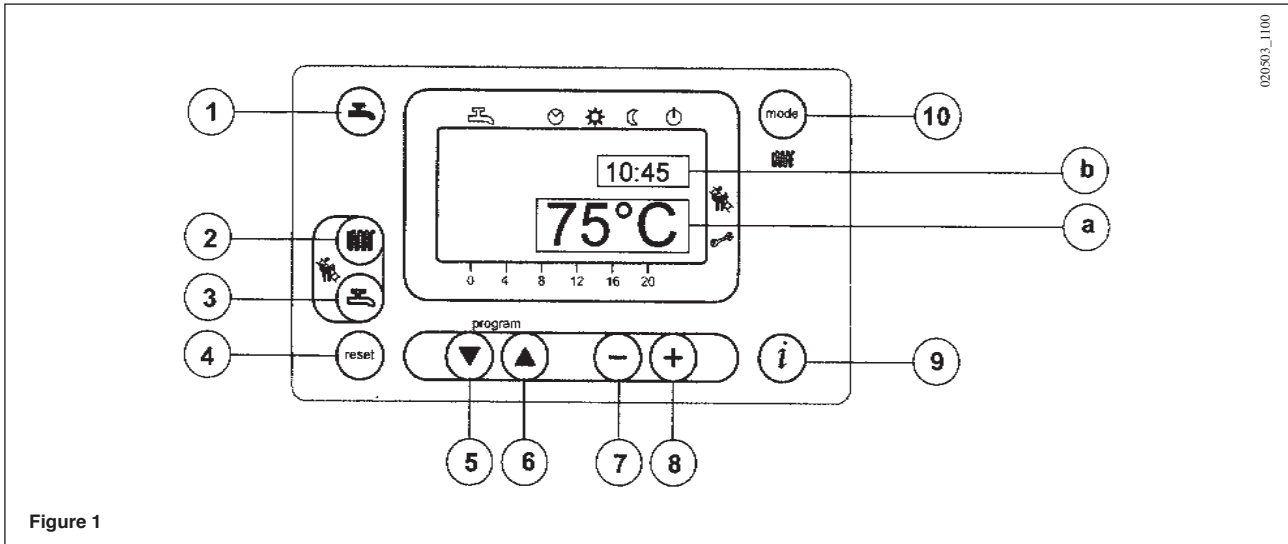

IMPORTANT: Domestic Hot Water (D.H.W.) instructions discribed here, are to be taken into account only if the boiler is connected to a D.H.W. production system.

KEYS

- Domestic hot water on/off key
- Central heating water temperature setting key
- Domestic hot water temperature setting key
- Reset key
- Program access and scroll keys
- Program access and scroll key
- Parameter setting key (decrease value)
- Parameter setting key (increase value)
- Data display reset key
- Central heating mode setting key

DISPLAY SYMBOLS

- Operation in domestic hot water mode
 - Operation in central heating mode
 - Operation in automatic mode
 - Operation in manual mode at the maximum temperature set
 - Operation in manual mode at minimum temperature
 - Standby (off)
 - Outdoor temperature
 - Flame present (on)
 - Resettable alarm warning
- a) MAIN display**
b) SECONDARY display

3.1 DESCRIPTION OF KEYS

 **(2) Central heating water temperature setting key.** This key can be pressed to set the central heating water output temperature as described in point 3-3.

 **(3) Domestic hot water temperature setting key.** This key can be pressed to set the domestic hot water temperature as described in point 3-4.

 **(10) Central heating mode operating key**

The  key can be pressed to activate four boiler central heating operating modes; these modes are identified by a black cursor line underneath the relative symbol on the display, and are as follows:

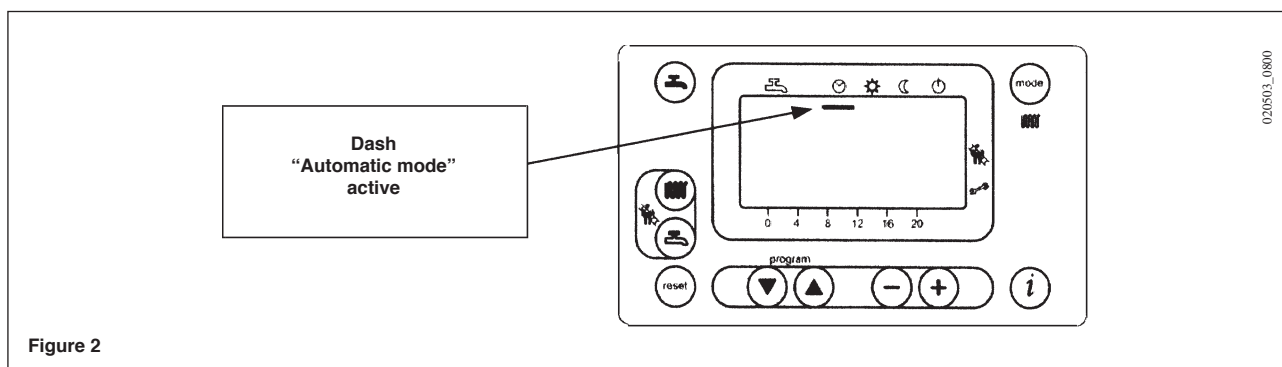















Figure 2



-  **Automatic operation.** Operation of the boiler is controlled by the timed program as described in point 3-5.1 “Daily timed program for operation of the central heating system”;
-  **Manual operation at the maximum temperature set.** The boiler comes into operation regardless of the timed program set. The operating temperature is that set using the  key (point 3-3: “Setting the maximum central heating temperature”);
-  **Manual operation at minimum temperature.** The operating temperature is that set in point 3-6: “setting the minimum central heating temperature”.
-  **Standby.** The boiler does not work in central heating mode, although the antifreeze function is still enabled.

 **(1) Domestic hot water on/off key:** This key can be pressed to activate or deactivate this function, which is identified on the display by a black cursor line under the symbol .





 **(4) Reset key.** In case of a fault, referred to in point 3-7 “Faults and resetting the boiler”, the boiler can be restarted by pressing this key for at least two seconds (see 3-8).
If this key is pressed with no fault present, the display will show the message “E153”, and the same key has to be pressed again (for at least two seconds) to restart the boiler.

 **(9) Data key.** This key can be pressed repeatedly to display the following information:
- Temperature (°C) of the domestic hot water ();
- outdoor temperature (°C) (); only provided with the outdoor temperature sensor probe connected.
Press either of the   keys to return to the main menu.

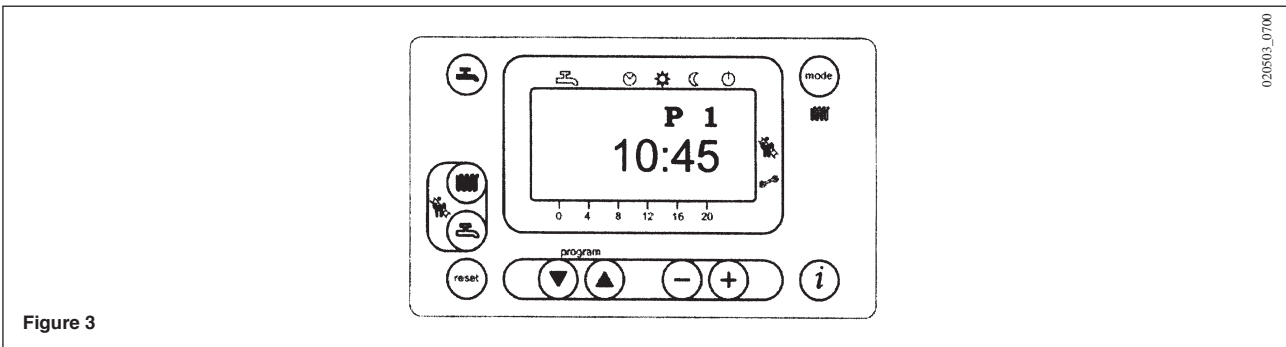



3.2 SETTING THE TIME



- Press either of the   keys to access the programming function; the display will show the letter P followed by a number (program line);







- Press the   keys until the display shows P1, referring to the time to be set;
- Press the   keys to set the time; on the display, the letter P will start to flash;
- Press the  key to save and exit the programming function;

3.3 SETTING THE MAXIMUM CENTRAL HEATING TEMPERATURE

- Press the  key (2-figure 1) to set the central heating water temperature;
- Press the   keys to set the temperature required;
- Press either of the   keys (1 or 10 - figure 1) to save and return to the main menu.







N.B – With the outdoor sensor connected, the  key (2 - figure 1) can be used to shift the central heating curve. Press the   keys to decrease or increase the room temperature in the premises to be heated.

3.4 SETTING THE MAXIMUM DOMESTIC HOT WATER TEMPERATURE

- Press the  key (3-figure 1) to set the maximum domestic hot water temperature;
- Press the   keys to set the temperature required;
- Press either of the   keys (1 or 10 - figure 1) to save and return to the main menu.

3.5 SETTING THE DAILY PROGRAM FOR OPERATION IN CENTRAL HEATING AND DOMESTIC HOT WATER MODES





3.5.1 Setting the daily times for central heating mode operation

- Press either of the   keys to access the programming function;
 - a) press these keys until the display shows P11, referring to the program start time;
 - b) press the   keys to set the time;
- Press the  key; the display will show P12, referring to the program end time;
- Repeat the operations described in points a and b until the third and last cycle is reached (program line P16);
- Press the  key to save and exit from the programming function.

3.5.2 Setting the daily times for domestic hot water mode operation

- Factory setting of D.H.W. function is enable (ON) while is disabled D.H.W. daily times program. To enable D.H.W. daily times program see section 14 (parameter H91).
Setting the daily times for domestic hot water mode operation-Carry out the operations described in section 3.5.1 for program lines 31 to 36.



3.6 SETTING THE MINIMUM CENTRAL HEATING TEMPERATURE

- Press either of the   keys to access the programming function;
- Press these keys until the display shows P5, referring to the temperature to be set;
- Press the   keys to set the temperature required.

This operating mode is enabled when minimum temperature central heating mode  is activated or when the daily central heating program does not require heat.

N.B – With the outdoor sensor connected, parameter P5 can be used to set the minimum room temperature in the premises to be heated (night set-back).

3.7 TABLE FOR USER-SETTABLE PARAMETERS

Parameter N.	Parameter description	Factory setting	Range
P1	Time of day setting	— — — —	0...23:59
P5	Minimum central heating temperature setting (°C)	25	25..80
P11	Start of first daily period of automatic central heating	6:00	00:00...24:00
P12	End of first daily period of automatic central heating	22:00	00:00...24:00
P13	Start of second daily period of automatic central heating	0:00	00:00...24:00
P14	End of second daily period of automatic central heating	0:00	00:00...24:00
P15	Start of third daily period of automatic heating	0:00	00:00...24:00
P16	End of third daily period of automatic central heating	0:00	00:00...24:00
* P31	Start of first daily period of domestic hot water production	0:00	00:00...24:00
* P32	End of first daily period of domestic hot water production	24:00	00:00...24:00
* P33	Start of second daily period of domestic hot water production	0:00	00:00...24:00
* P34	End of second daily period of domestic hot water production	0:00	00:00...24:00
* P35	Start of third daily period of domestic hot water production	0:00	00:00...24:00
* P36	Fine End of third daily period of domestic hot water production	0:00	00:00...24:00
P45	Reset of daily central heating and domestic hot water production programs (factory settings). Press the - + keys together for about 3 seconds; the number 1 appears on the display. Confirm by pressing either of the   keys	0	0...1

* Parameters for program lines **P31** to **P36** are displayed only if Domestic Hot Water (D.H.W.) program (parameter H91 see section 14) is activated.

3.8 FAULT WARNINGS AND RESETTING THE BOILER

If a fault occurs, a flashing warning code appears on the display.

The fault warnings appear on the main display (figure 1 a) together with the  symbol (Figure 4).

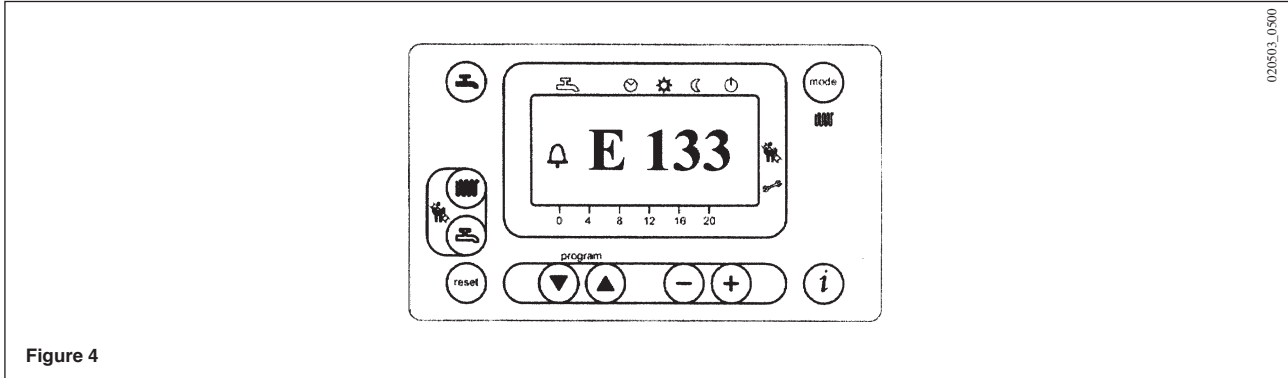

To reset, press the reset  button for at least two seconds.

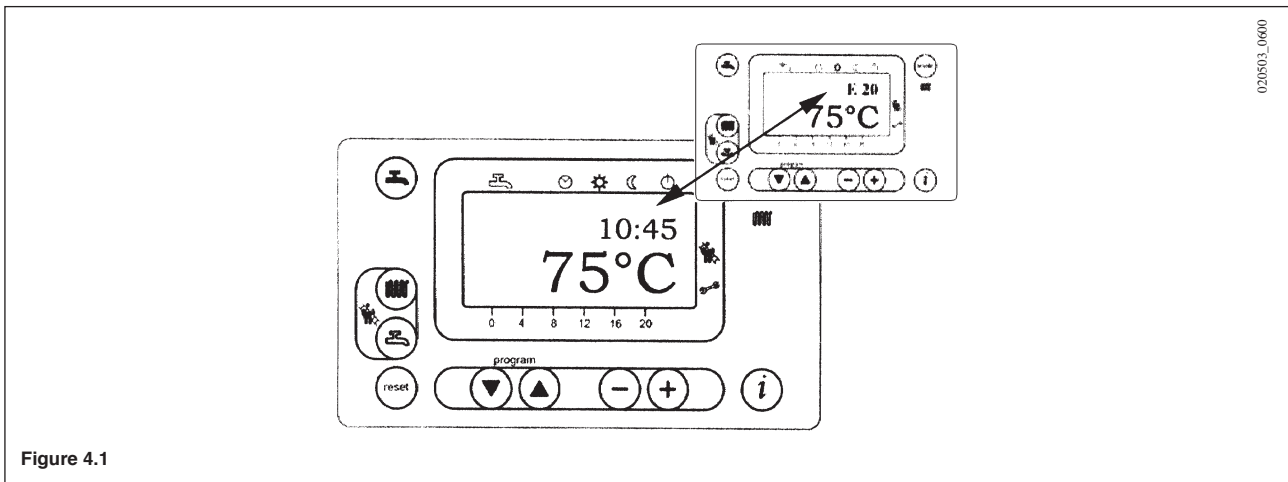

Fault warnings appear on the secondary display (figure 1 b) alternating with the time, both of them flashing (figure 4.1). It is not possible to reset malfunction warnings which appear on the secondary display as the cause of the alarm has first to be removed.



3.9 TABLE OF FAULTS AND ERROR MESSAGES

Error code	Description of fault	Corrective action
E10	Outdoor temperature sensor fault	Call an authorised service centre (*).
E20	NTC output sensor failure	Call an authorised service centre (*).
E50	Hot water NTC sensor failure	Call an authorised service centre (*).
E110	Safety or flue gas thermostat tripped	Press the reset key (for about 2 seconds: if this device is triggered repeatedly, call the authorised service centre)
E128	Loss of flame during operation (the ionization current has fallen below the limit)	Call an authorised service centre.
E129	Minimum fan speed limit not reached	Call an authorised service centre.
E132	Gas pressure switch tripped / external thermostat tripped	Call an authorised service centre to check the gas pressure.
E133	No flame detected	Press the reset key (for about 2 seconds); if the fault persists, call the authorised service centre to check polarity of ignition electrodes, ionisation current.
E151	Boiler circuit board error	If  symbol is displayed, press the reset  button otherwise switch off the electricity supply to the boiler for at least 10 seconds; if the fault persists, call the authorised service centre. Check the positioning of the ignition and flame sensing electrode (see section 16).
E153	The reset key has been pressed inappropriately	Press the key again (about 2 seconds)
E154	Internal error on boiler circuit module	Press and hold reset button (2 seconds approx.) then press again when warning E153 appears
E160	Fan speed threshold not reached	Call an authorised service centre.
E164	Low water pressure	Check that the system is at the rated pressure. (Refer to the section on filling the system). If the fault persists, call the authorised service centre.

(*) Autoreset when fault disappears.

All the faults are displayed in order of importance; if several faults occur simultaneously, the first to be displayed is the one with highest priority. After the cause of the first fault has been removed, the second one will be displayed, and so on.

If any given fault occurs frequently, contact the authorised Service Centre.

4. FILLING THE SYSTEM

IMPORTANT: Regularly check that the pressure displayed by the pressure gauge is 1 ÷ 4 bar when the central heating system is cold. Open the boiler drain cock to reduce pressure if it is too high. Open the filling cock to increase pressure if it is too low.

Always open the filling cock very slowly to allow any air to bleed off.

If the pressure in the system drops frequently, contact an authorised service centre to have the system checked.

5. SWITCHING THE BOILER OFF

To shut down the boiler switch off the electrical supply to the appliance.

6. PROLONGED STANDSTILL OF THE SYSTEM. FROST PROTECTION

We recommend you avoid draining the whole system as raw water makeup will lead to harmful limestone deposits inside the boiler and on the heating elements.

In case the boiler is not operated during wintertime and is therefore exposed to danger of frost we suggest you add some specific-purpose anti-freeze to the water contained in the system (e.g.: propylene glycole coupled with corrosion and scaling inhibitors).

The electronic management of the boilers includes a “frost protection” function in the central heating system which operates the burner to reach a heating flow temperature of 30° C when the system heating flow temperature drops below 5°C.

The frost protection function is enabled if:

- * electrical supply to the boiler is on;
- * the gas service cock is open;
- * the system pressure is as required;
- * the boiler is not isolated.

7. SERVICING INSTRUCTIONS AND GAS CHANGE

To maintain efficient and safe operation of your boiler have it checked by a Qualified Service Engineer at the end of every heating season.

Careful servicing will ensure economical operation of the system.

Do not clean the outer casing of the appliance with abrasive, aggressive and/or easily flammable cleaners (i.e.: gasoline, alcohol, and so on). Always isolate the electrical supply to the appliance before cleaning it (see section 5 Turning off the boiler).

***These boilers are produced for natural gas and can be converted to work with LPG (G 31).
Any gas change must be effected by a Qualified Service Engineer.***

8. GENERAL INFORMATION

The following remarks and instructions are addressed to Service Engineers to help them carry out a faultless installation. Instructions regarding lighting and operation of the boiler are contained in the 'Instructions pertaining to the user' section.

Note that installation, maintenance and operation of the gas appliances must be performed exclusively by qualified personnel in compliance with current standards.

Please note the following:

- Install the boiler in a permanent ventilated central heating boiler room.
- This boiler can be connected to any type of convector plates, radiators, thermoconvectors. Design the system sections as usual though taking into account the available output / pump head performances, as shown in chapter 10.4.
- Do not leave any packaging components (plastic bags, polystyrene, etc.) within children's reach as they are a potential source of danger.
- Initial lighting of the boiler must be effected by a Qualified Service Engineer.
- Make sure that the room where the boiler is installed has a sufficient supply of air to ensure complete combustion of the gas consumed by the appliance. Install unblockable ventilation grilles as necessary in accordance with the Rules in force.
- Connect the boiler directly to an efficient flue to vent all fumes and combustion gases outdoors. Make sure that the pipe connecting the boiler to the flue is not smaller in diameter than the boiler's flue outlet. Make sure that the flue is in good condition and free from holes or cracks that could reduce draw.

Failure to observe the above will render the warranty null and void.

9. INSTRUCTIONS PRIOR TO INSTALLATION

This boiler is designed to heat water at a lower than boiling temperature at atmospheric pressure. The boiler must be connected to a central heating system and/or to a domestic hot water supply system in compliance with its performances and output power.

IMPORTANT! The following components are not installed in the boiler as supplied. It is the installer's responsibility to provide them:

- **Expansion vessel;**
- **Pressure safety valve;**
- **Circulation pump;**
- **Filling system cock.**

Before connecting the boiler ensure the following operations have been completed:

- a) Check that the boiler is fit for operation with the type of gas available. For more details see the notice on the packaging and the label on the appliance itself.
- b) Check that the flue terminal draft is appropriate; that the terminal is not obstructed and that no other appliance exhaust gases are expelled through the same flue duct, unless the flue is especially designed to collect the exhaust gas coming from more than one appliance, in conformity with the standards and regulations in force.
- c) Check that, in case the flue has been connected to pre-existing flue ducts, thorough cleaning has been carried out in that residual combustion products may come off during operation of the boiler and obstruct the flue duct.

To ensure correct operation of the appliance and avoid invalidating the warranty, observe the following precautions:

1. Heating circuit

1.1. New system

Before proceeding with installation of the boiler, the system must be cleaned and flushed out thoroughly to eliminate residual thread-cutting swarf, solder and solvents if any, using suitable proprietary products.

To avoid damaging metal, plastic and rubber parts, use only neutral cleaners, i.e. non-acid and non-alkaline. The recommended products for cleaning are:

SENTINEL X300 or X400 and FERNOX heating circuit restore. The use of this product must be strictly in accordance with the maker's directions. Finally the system must be dosed with a suitable inhibitor at 1% system volume.

1.2. Existing system

Before proceeding with installation of the boiler, the system must be cleaned and flushed out to remove sludge and contaminants, using suitable proprietary products as described in section 1.1.

To avoid damaging metal, plastic and rubber parts, use only neutral cleaners, i.e. non-acid and non-alkaline such as SENTINEL X100 and FERNOX heating circuit protective. To use this product proceeding strictly in accordance with the maker's directions.

Remember that the presence of foreign matter in the heating system can adversely affect the operation of the boiler (e.g. overheating and noisy operation of the heat exchanger). Dose with inhibitor.

Failure to observe the above will render the warranty null and void.

10. BOILER INSTALLATION AND DIMENSIONS

Install the boiler in a position that ensures easy maintenance. You must be able to fully open the front access door and have adequate access to the rear of the boiler.

If possible, install the boiler on a raised base of 200 mm in height to facilitate drainage of flue condensate.

When calculating the weight of the boiler on the floor, bear in mind the weight of the water in the heat exchanger (see table 1).

Adjust the levelling feet to compensate for any unevenness in the floor.

Install the necessary utility connections starting from the water and gas connections on the rear of the boiler (see table 1 for fitting type and size).

These appliances do not have any circulation pump, expansion tank or safety valve. These devices must therefore be provided elsewhere in the system, and must be sized to suit the system's thermal capacity.

Connect the flue condensate drain pipe to a suitable water drain, ensuring an adequate slope.

To drain the boiler, use the drain tap at the rear.

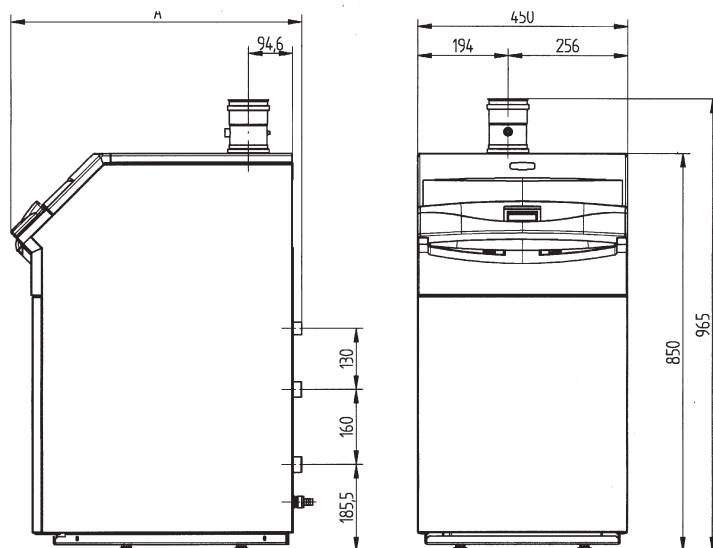

Insert the flue-gas union and fasten the connector to the flue-gas thermostat

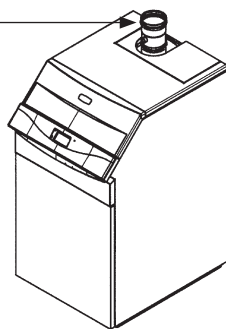

- MR: heating flow
- RR: heating return
- GAS: gas inlet to the boiler
- SC: condensate drain

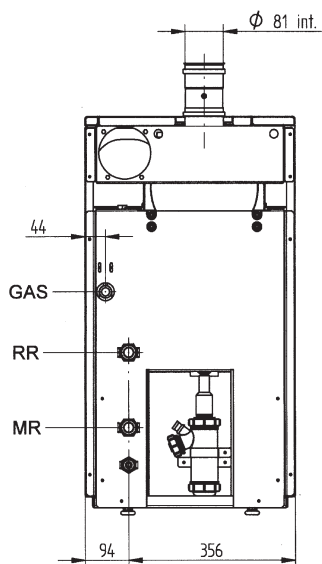

Figure 5

Model	Depth (mm) Ⓐ	Height (mm)	Width (mm)	Gas fitting	Fitting F (CH)	Fitting R (CH)	Water contents (l)
FS 50	621	850	450	G 3/4"	G 1"	G 1"	5,1
FS 70	693	850	450	G 3/4"	G 1"	G 1"	6,5

Table 1

10.1 HYDRAULIC SYSTEM 1

(Pumped heating circuits with remote control QAA73 or Room Thermostat, including hot-water tank, with primary loop)

Applications and Installation Details

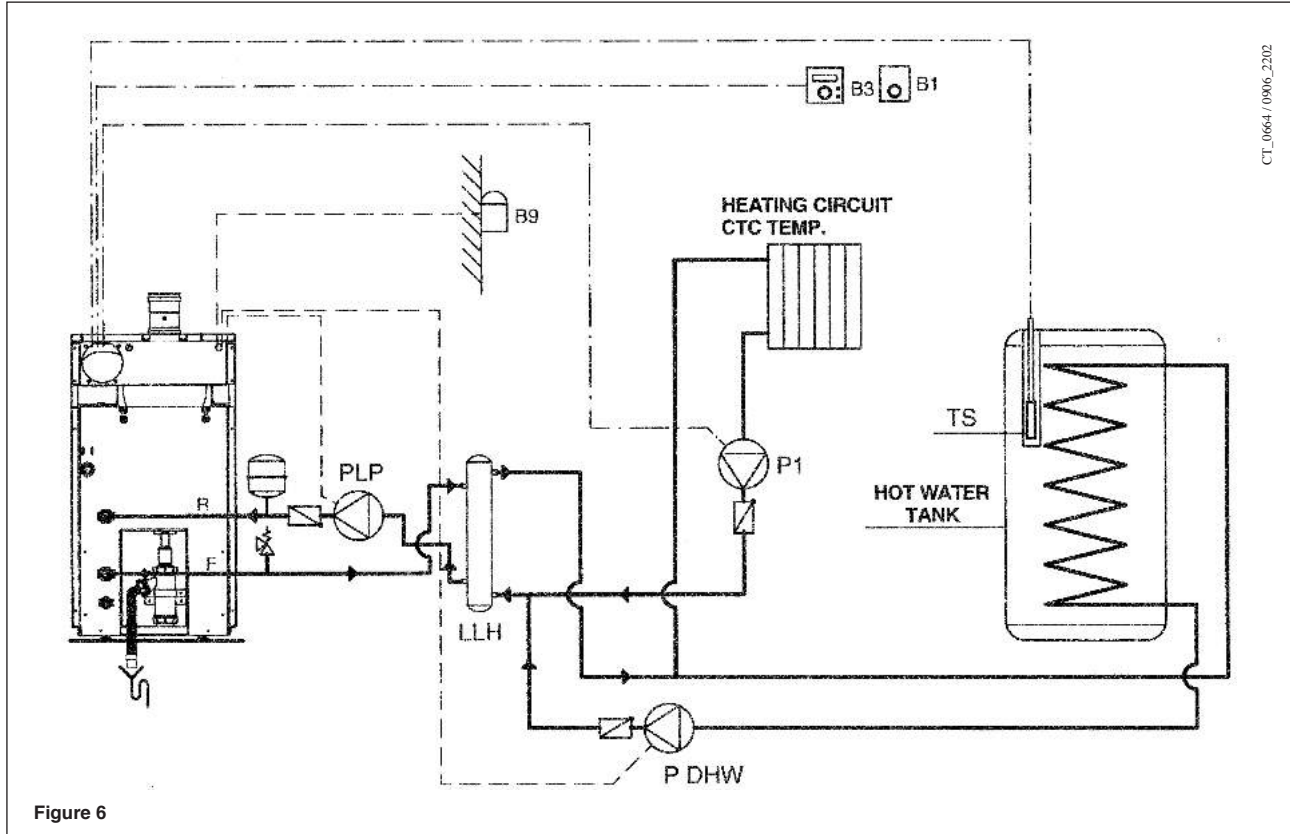

- TS: Tank Sensor (QAZ36)*
- B3: Room Control Module (QAA73)*
- B1: Room Thermostat*
- B9: Outdoor Temperature Sensor (QAC34) supplied with the boiler
- P1: Heating Pump
- PDHW: Hot Water Pump
- PLP: Primary Pump

(*) Available Optional Extra

- Pumps, Hot Water Cylinder, Low Loss Header , Non return valve (Not supplied)
- Installer Wiring -----

Applications (pumps, sensor, remote control ...) have to be connected to terminal as follows (see also section 12):

APPLICATION	WITH QAA73 REMOTE CONTROL	WITH ROOM THERMOSTAT
	TERMINAL BOARD	TERMINAL BOARD
PRIMARY PUMP PLP	M1: A – B	M1: A – B
DHW PUMP PDHW	M3: 13 – 14	M3: 13 – 14
HEATING PUMP P1	M3: 11 – 12	M3: 11 – 12
DHW SENSOR TS	M2: 7 – 8	M2: 7 – 8
REMOTE CONTROL QAA73	M2: 1 – 2	NO
ROOM THERMOSTAT	M2: 3 – 4 OPEN	M2: 3 – 4

Parameter changes requires (see also section 14):

PCB PARAMETER	Description	Setting Parameter
H552	Hydraulic system	H552 = 2 (*)
H553	KonfigHKS	H553 = 21 (*)
H615	KonfigAusgang	H615 = 9 (*)
H632	WANFO Q8	H632 = 00001100 (*)

(*) factory set

10.2 HYDRAULIC SYSTEM 2

(Pumped heating circuits with Room Thermostats and compensated circuit with remote control QAA73, including hot-water tank, with primary loop)

Applications and Installation Details

- TS: Tank Sensor (QAZ36)*
- B3: Room Control Module (QAA73)*
- B1: Room Thermostat*
- B9: Outdoor Temp Sensor (QAC34) supplied with the boiler
- AGU2.500: Zone controller (Clip-in AGU2.500)*
- FS: Flow Sensor (QAD36: supplied with the AGU2.500)*
- P1: CTC Heating Pump
- P DHW: Hot Water pump
- PLP: Primary Pump
- 3WV: 3-Way Valve (power open / power close)
- P2: VTC Pump

(*) Available Optional Extra

- Pumps , Hot Water Cylinder, Low Loss Header, Non return valve (Not supplied)
- Installer Wiring -----

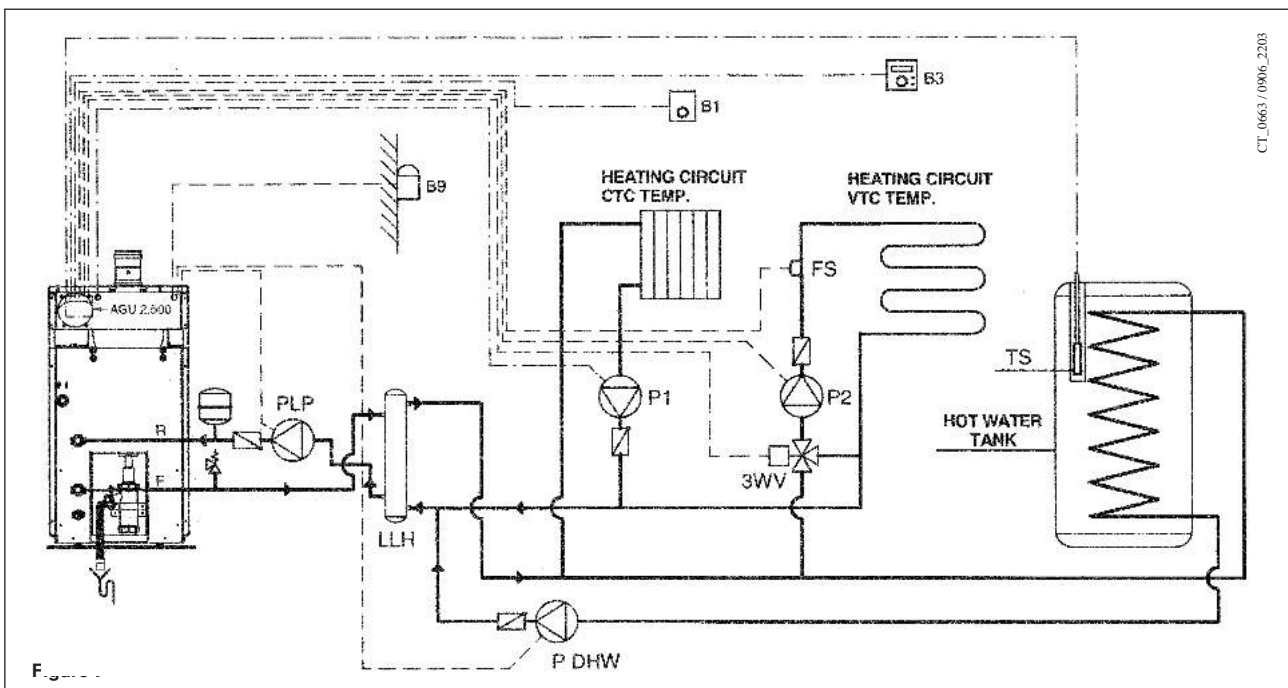

Applications (pumps, sensor, remote control ...) have to be connected to terminal as follows (see also section 12):

APPLICATION	
	TERMINAL BOARD
PRIMARY PUMP PLP	M1: A – B
DHW PUMP PDHW	M3: 13 – 14
HEATING PUMP P1	M3: 11 – 12
DHW SENSOR SB	M2: 7 – 8
REMOTE CONTROL QAA73 (LOW TEMPERATURE)	M2: 1 – 2
ROOM THERMOSTAT	M2: 3 – 4
HEATING PUMP P2	CLIP IN AGU 2.500
3 WAY VALVE 3WV	CLIP IN AGU 2.500
FLOW SENSOR FS	CLIP IN AGU 2.500

Parameter changes requires (see also section 14):

PCB PARAMETER	Description	Setting Parameter
H552	Hydraulic system	H552 = 50
H553	KonfigHKS	H553 = 12
H615	KonfigAusgang	H615 = 9
H632	WANFO Q8	00001111

10.3 HYDRAULIC SYSTEM 3

(Cascade with pumped heating circuits, Room Thermostats, primary loop)

Applications and Installation Details

- RT: Room Thermostat*
- B9: Outdoor Temperature Sensor (QAC34) supplied with the boiler
- OCI 420: Cascade interface controller (Clip-in OCI 420)*
- RVA 47: Cascade controller (RVA 47)*
- FS: Flow/return Sensor (QAD21)*
- P1: Heating Pump
- PLP: Primary Pump

(*) Available Optional Extra

- Pumps , Hot Water Cylinder, Low Loss Header, Non return valve (Not supplied)
- Installer Wiring -----

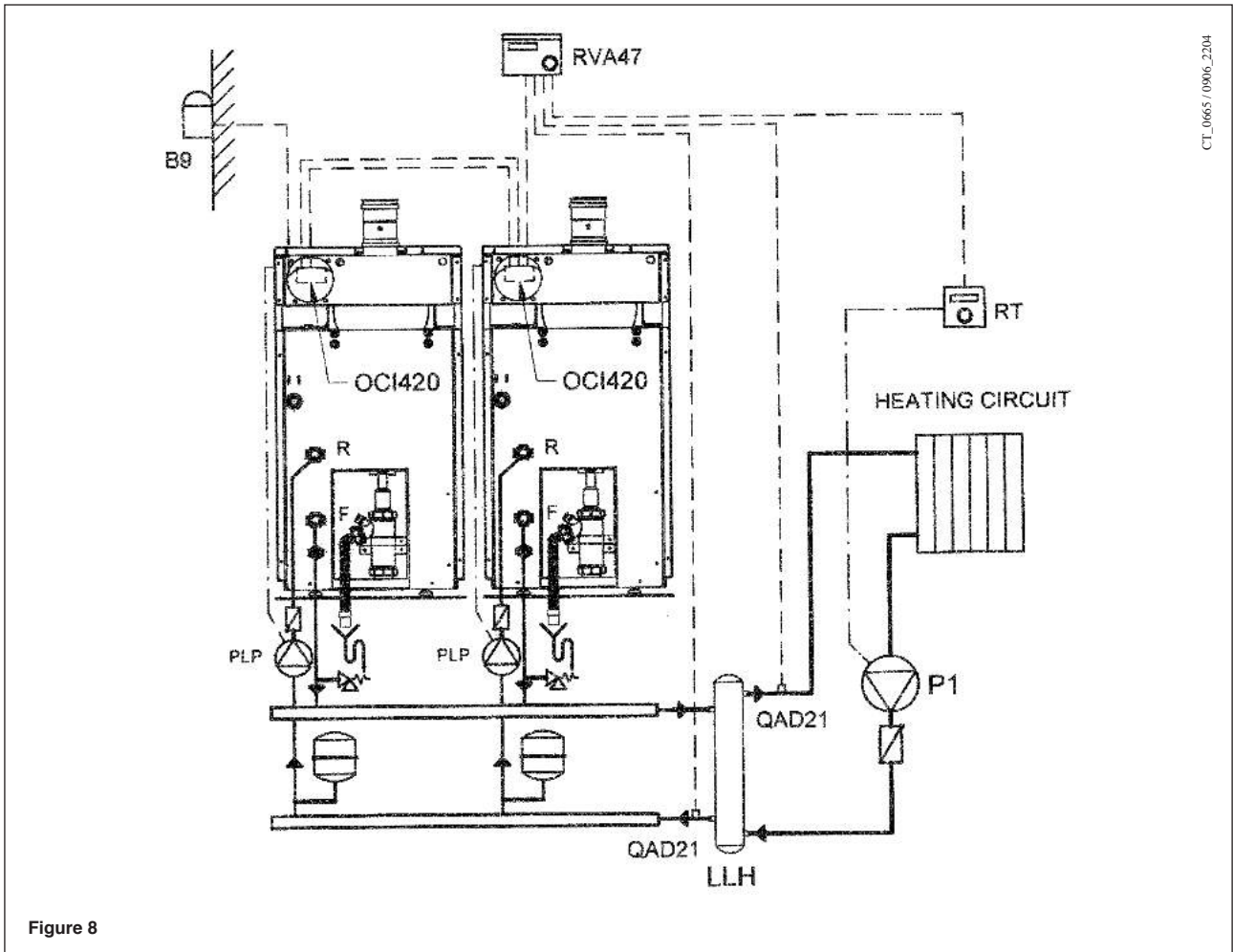

Applications (pumps, sensor, remote control ...) have to be connected to terminal as follows (see also section 12):

APPLICATION	TERMINAL BOARD
PRIMARY PUMP PLP	M1: A – B
HEATING PUMP P1	RVA 47
ROOM THERMOSTAT	RVA 47
FLOW/ RETURN SENSOR QAD 21	RVA 47

Parameter changes requires (see also section 14):

PCB PARAMETER	Description	Setting Parameter
H552	Hydraulic system	H552 = 80
H553	KonfigHKS	H553 = 21
H615	KonfigAusgang	H615 = 9
H632	WANFO Q8	00001111

If DHW circuit is required then DHW pump and DHW sensor have to be connected to terminal of RVA 47 Cascade Controller.

For more details refer to the instruction provided with the accessories RVA 47 and RVA 46 (compensated circuit).

10.4 EXCHANGERS PRESSURE DROP

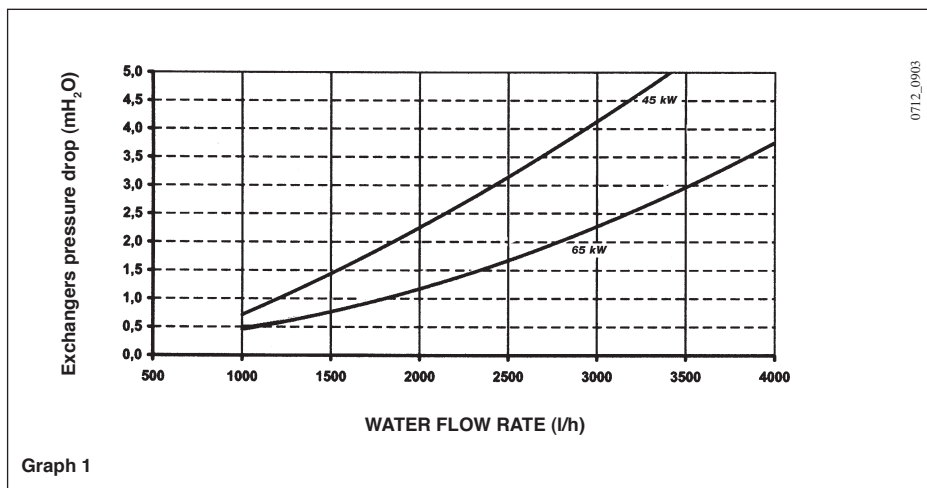

**FS 50 - 70
EXCHANGER
PRESSURE DROP.**

Graph 1

Boiler	Hydraulic Resistance and Water Flow Rates							
	11°K ΔT		15°K ΔT		20°K ΔT		30°K ΔT	
	kPa	Lit/sec	kPa	Lit/sec	kPa	Lit/sec	kPa	Lit/sec
FS 50	50	0,97	32	0,71	25	0,53	10	0,35
FS 70	60	1,41	35	1,03	20	0,77	11	0,51

Boiler	Minimum Water Flow Rates	
	Lit/sec	
FS 50	0,27	
FS 70	0,33	

11. CHIMNEY FLUE CONNECTION

Connect the boiler to the flue using a pipe made of stainless steel or plastic material with an internal diameter of 80 mm, capable of resisting normal mechanical stresses over time, as well as high temperatures (<120°C) and the chemical effects of fuel gases and their condensates.

Insert the flue-gas union and fasten the connector to the flue-gas thermostat before hooking up to the flue.

Whenever possible use a flue connection that can be disconnected for maintenance.

Important! Horizontal flue sections must have a minimum slope of 3° towards the boiler.

Flue accessories made of plastic material for cascade or single installations are available.

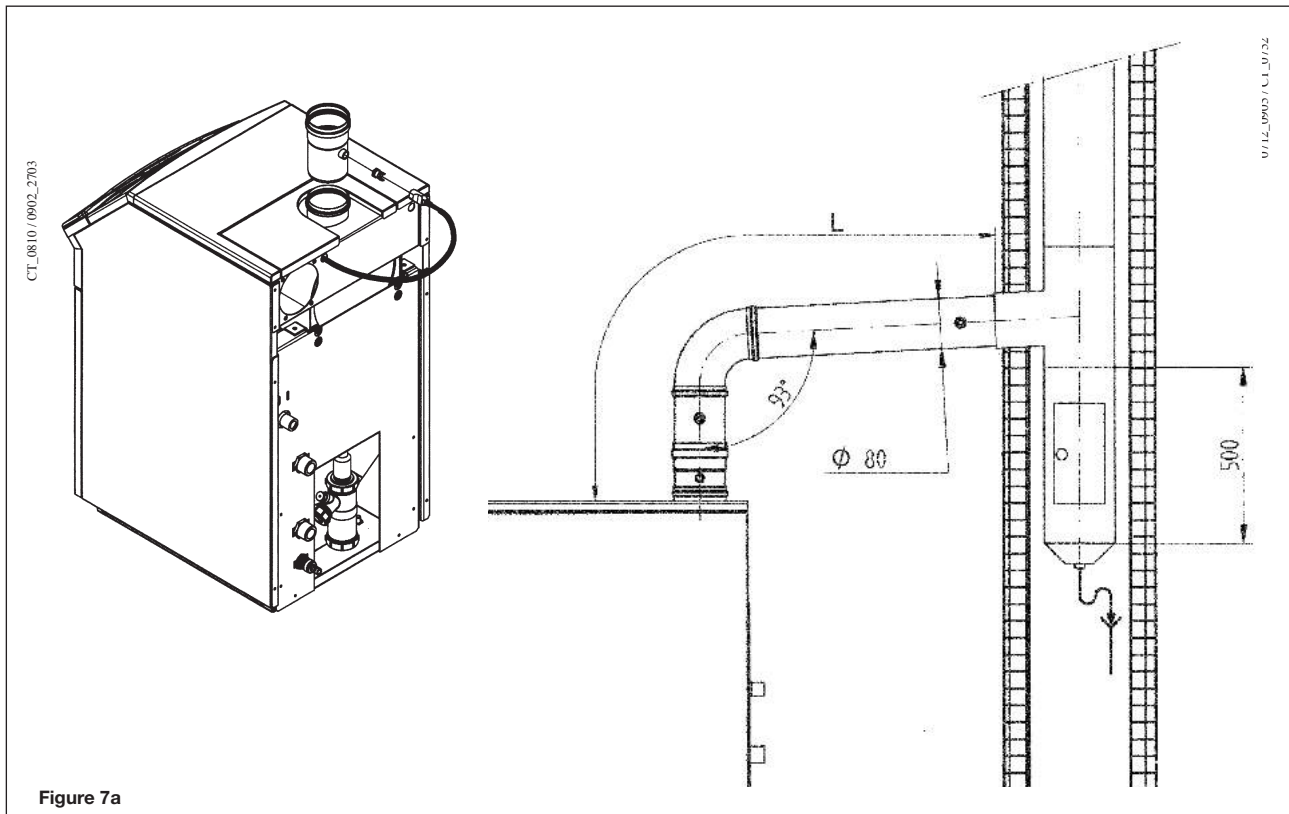

- Max. length of flue duct (model HTE 45) : **30 m (L)**
- Max. length of flue duct (model HTE 65) : **20 m (L)**
- Each 90° bend reduces the duct max. length by : **1 m**
- Each 45° bend reduces the duct max. length by : **0.5 m**

TABLE FUMES PRESSURE AVAILABLE

	ΔP available flue duct B23 Ø 80	Cascade solution
		ΔP available with single non-return valve Ø 110/110
FS 50	150	110
FS 70	150	100

11.2 CONNECTOR WITH C53 TYPE

The kit is used to introduce combustion air from outside the installation area and comprises a hose to be installed in the mixer body.

Please consult the instructions supplied with the kit.

For air ducts (diameter and length), see the kit manual.

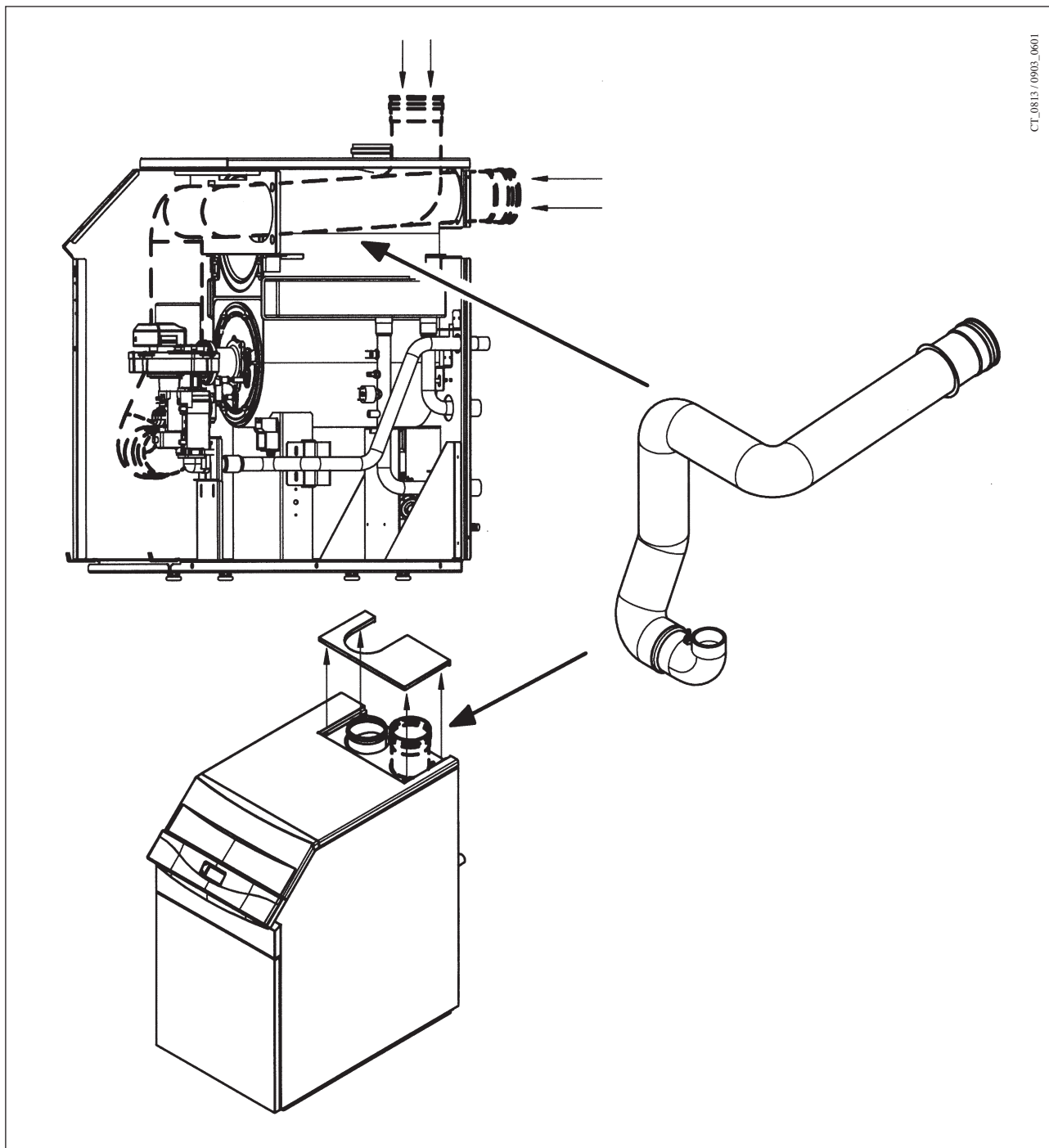

12. MAKING THE ELECTRICAL CONNECTIONS

Electrical safety of the appliance is only guaranteed by correct earthing, in accordance with the current standards and regulations.

Connect the boiler to a 230V by means of the three-pin cable supplied with it make sure that the polarities are correctly connected.

Use a double-pole switch with a contact separation of at least 3mm in both poles.

In case you replace the power supply cable fit a HAR H05 VV-F' 3x0.75mm² cable with an 8mm diameter maximum outer sheath.

IMPORTANT: Check that the overall current drawn by accessories connected to the appliance is less than 2 amp. If the value is greater, a relay must be wired between the boiler control circuit board and the accessories drawing the higher current.

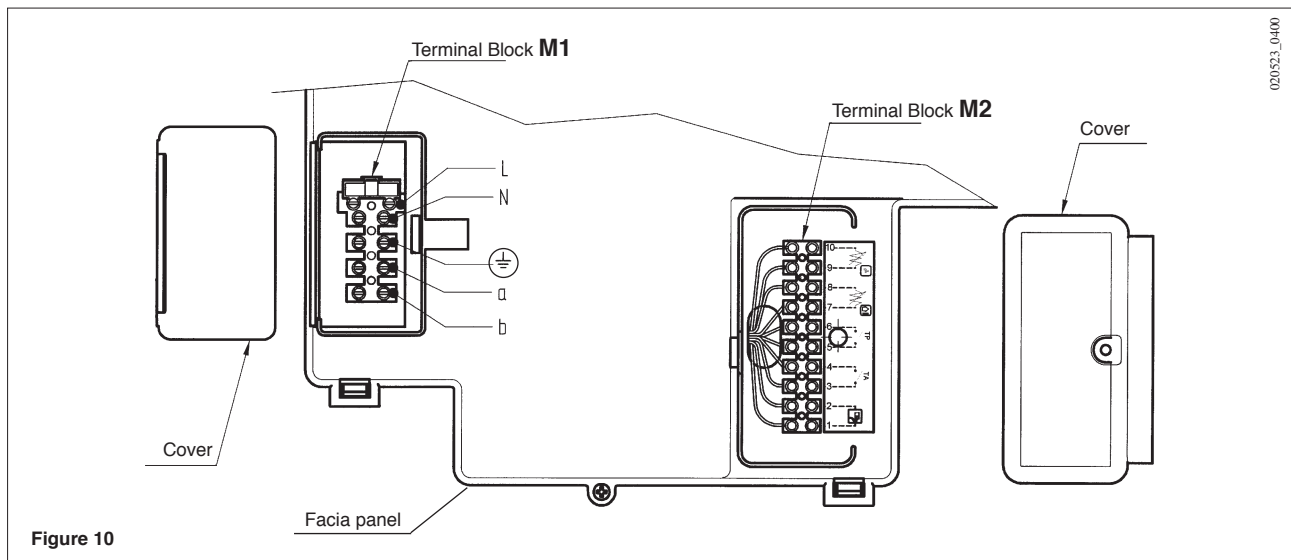

12.1 TERMINAL BLOCKS ACCESS

- Isolate power to the boiler with the two-pole switch.
- Remove the top facia panel cover (which is held by magnets).
- Unscrew the two screws holding the facia panel in place.
- Swing the facia panel forwards.

Main terminal block M1

- Remove the clip-on cover from terminal strip M1.
- The main terminal block incorporates a fast blow 3.15 A fuse (figure 10). Remove the black fuse holder to check and/or replace the fuse.

Terminal block M2

- Unscrew the fixing screw and remove the cover from terminal block M2.

Terminal block M3

- Unscrew the fixing screws and remove the main cover.

12.2 CONNECTING THE PUMPS

Turn the control box downward to access terminal boards M1 and M3 used for the electrical connections by removing the protective covers (see figure 11).

Terminals M1 a – b: connection of the Primary loop pump for the heating system (PLP)

Check the correct size and rating of the pump by referring to graph n° 1, which shows the boiler pressure losses.

Terminals M3 11 – 12: connection for heating pump (P1)

Terminals M3 13 – 14: connection for hot water tank pump (PDHW)

The electrical specifications of the pump must be as follows:

230 V AC; 50 Hz; 1 A max; $\cos \phi > 0.8$.

If the specifications of the installed pump are different, a relay must be wired between the boiler control circuit board and the pump.

It is advisable not to adopt any electrical connection other than those described.

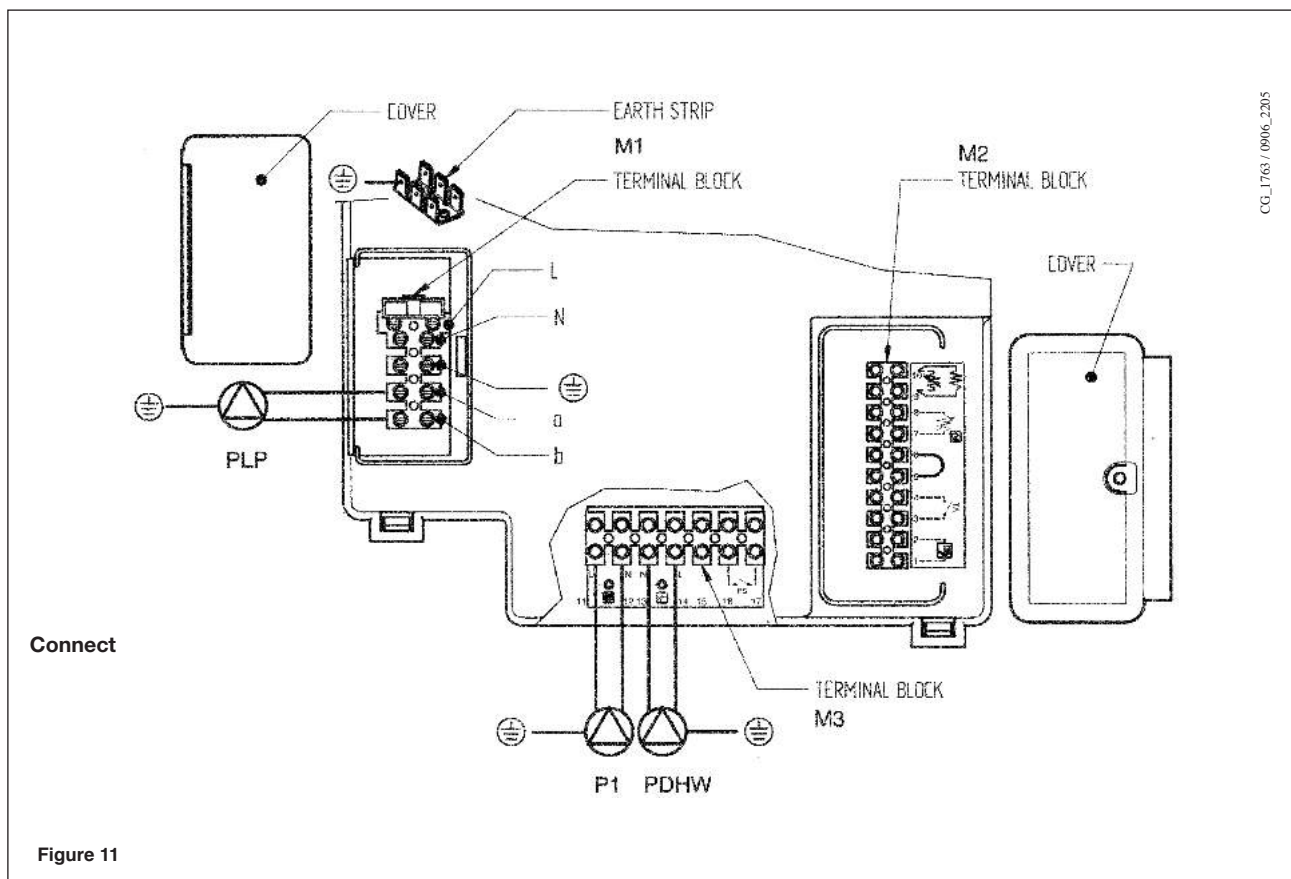

12.3 CONNECTING THE HOT WATER TANK SENSOR

Remove the resistor from terminals 9-10 of terminal strip M2 (figure 12), and connect the hot water priority NTC sensor, which is supplied as an accessory.

The sensing element of the NTC device must be located in the recess provided on the storage tank (figure 12).

The temperature and on-off programming of the domestic hot water supply are selected directly from the boiler control panel, as described in this manual under the user instruction headings.

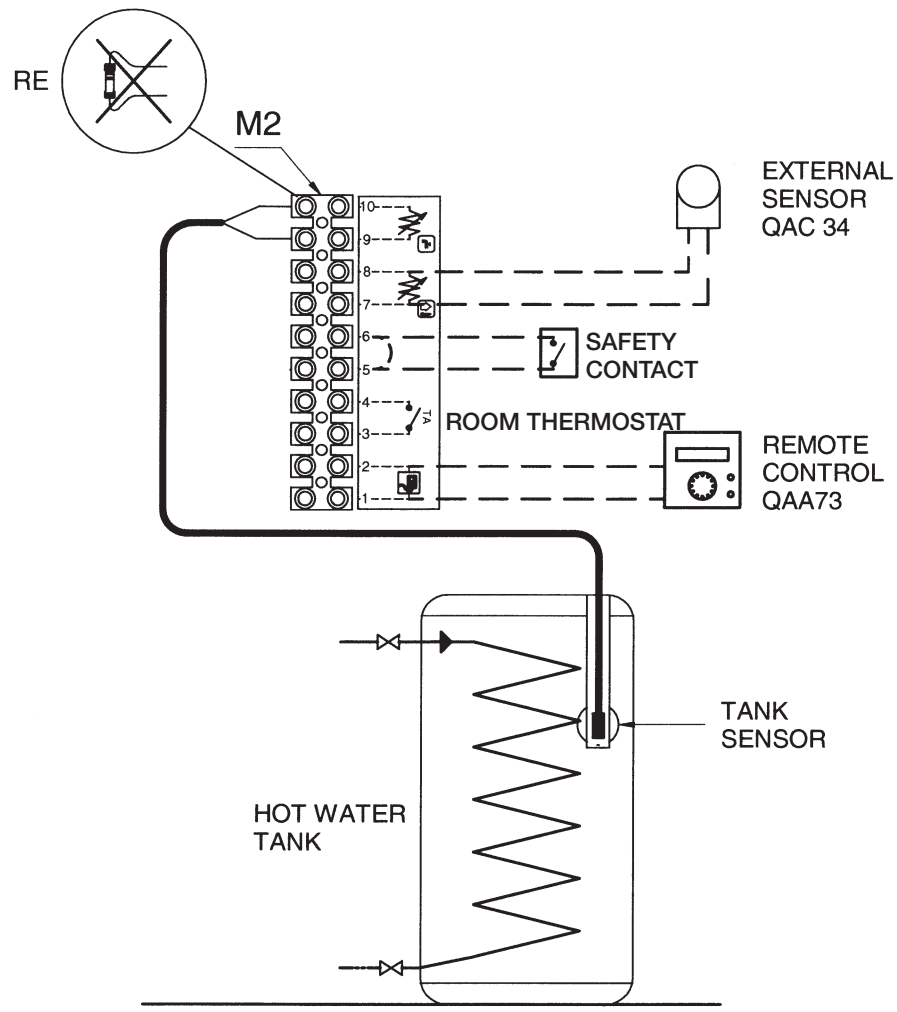

Figure 12

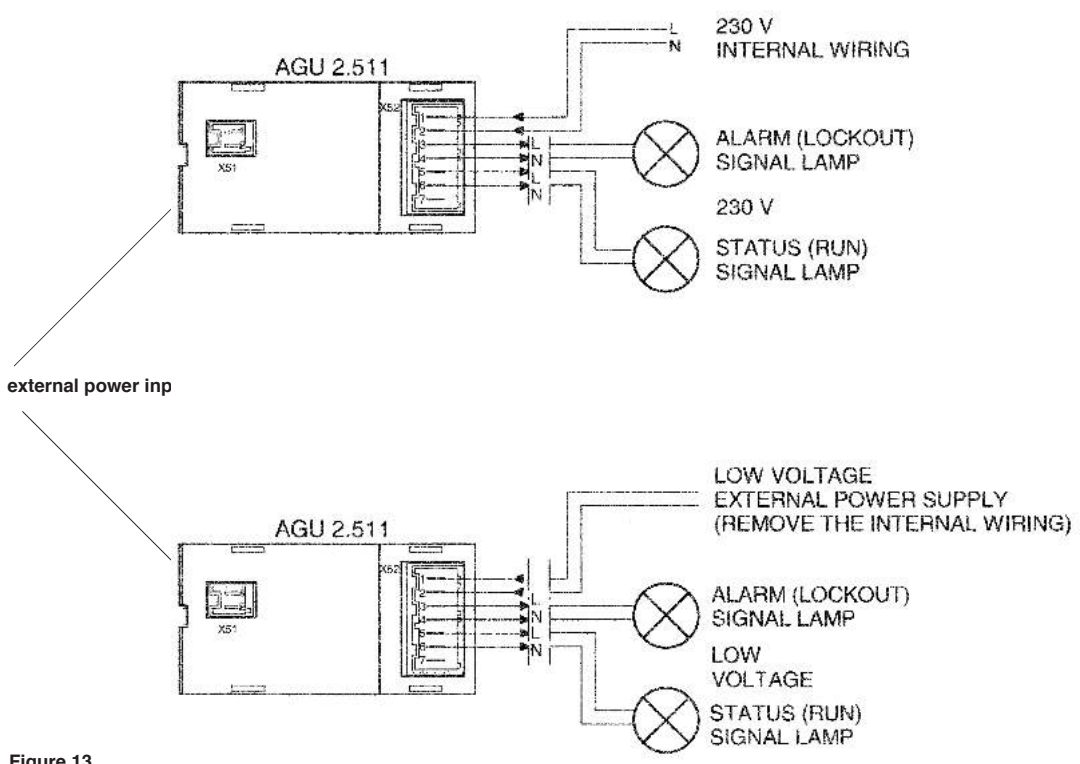

Figure 13

12.4 DESCRIPTION OF THE ELECTRICAL CONNECTIONS TO THE BOILER

Turn the control box downward to access terminal blocks M1 and M2 used for the electrical connections by removing the two protective covers (see figure 10).

Terminals 1-2: connections for the optional SIEMENS QAA73 (optional extra) room temperature regulator. These connections do not have any specific polarity.

Remove the bridge between terminals 1-2 "TA" on terminal block M1.

Read the instructions provided with the temperature regulator to ensure correct installation and programming.

Terminals 3-4: room temperature thermostat "TA". Thermostats with integral accelerator resistor must not be used. Check that there is no voltage across the ends of the two thermostat connection wires.

Terminals 5-6: external safety contact (commercially available device).

Terminals 7-8: connections for the optional SIEMENS QAC34 outdoor temperature sensor supplied with the boiler. Read the instructions provided with the outdoor temperature sensor to ensure correct installation.

Terminals 9-10: connections for the optional domestic hot water priority sensor, for connecting single system boilers to external DHW boilers.

CLIP-IN AGU 2.511

Terminals 3-4 L-N OUT: connection to signal lamp (230 V - 0,5 A max) for lockout alarm.

Terminals 5-6 L-N OUT: connection to signal lamp (230 V - 0,5 A max) for run mode.

Terminals X51 (1-2): connection to external power input 0÷10 V.

pin 1: positive power input

pin 2: negative power input

For low voltage signal lamp remove the internal wiring and feed with an external low voltage power supply.

12.4.1 CONNECTING EXTERNAL SIGNAL (0÷10V)

Electronic board parameter settings

- 1 Hold down buttons ▲ ▼ on the boiler panel for at least 6 seconds until the display indicates "-----";
- 2 Press buttons ▼ ▲ +-+ in sequence: **Attention, this procedure accesses the "manufacturer" parameters. Do not modify any parameters apart from those shown below.**
- 3 Press button ▲ to select the parameters in ascending order; press button ▼ to select the parameters in descending order. Press +/- to modify the display parameter;
The parameters to modify are **H618 = 5; H623 = 50;**

The changes are automatically saved when a new parameter is selected;

- 4 Press ⓘ to save and exit the programming level.

LIST OF PARAMETERS

<i>Parameter</i>	<i>Description of parameters</i>	<i>Range</i>	<i>Default setting</i>	<i>Required setting</i>
618	KONFIGEINGANR: Setting for programmable clip-in input	0 ÷ 8	0	5
623	PANFOEXTECHWELLE: Threshold of the analogue signal from which the external heat demand is accepted (percentage of the maximum value of the analogue signal)	5 ÷ 95	5	50

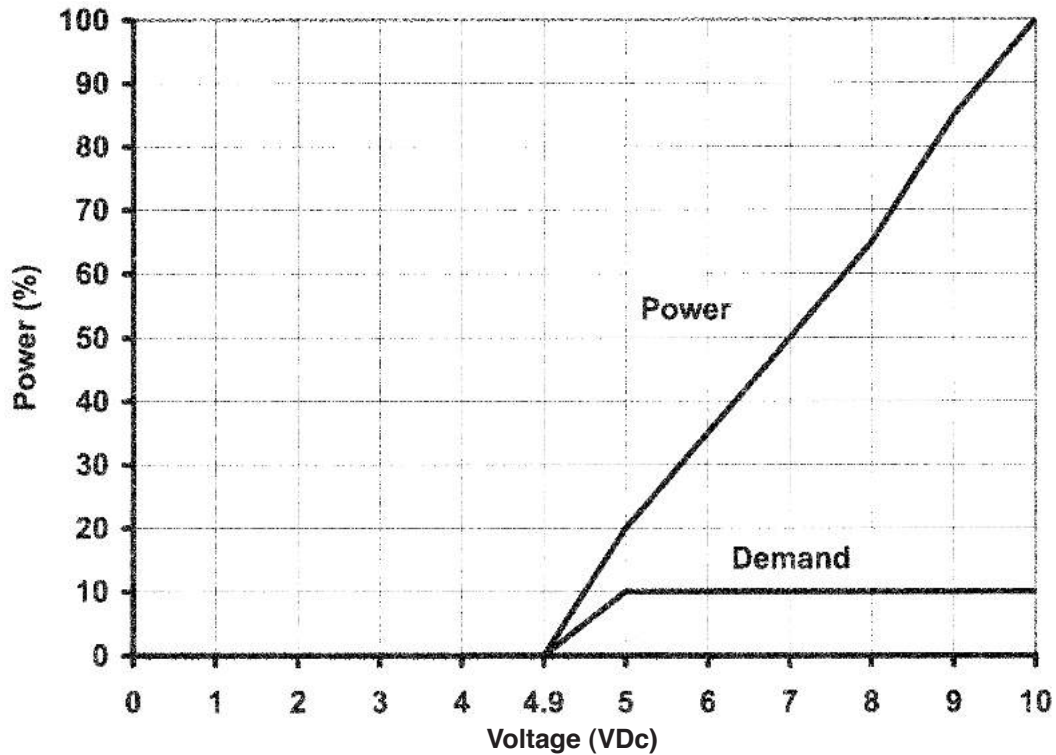

Boiler heating performance according to the voltage on the connector (with voltage above 5V).

NB: Demand active = 10
Demand inactive = 0

12.5 CONNECTING THE QAA73 ROOM TEMPERATURE REGULATOR

The SIEMENS model QAA73 room temperature regulator, if required (optional accessory) must be connected to terminals 1-2 of terminal block M2 in figure 12.

The link across terminals 3-4, provided for connection of a room temperature thermostat, must be removed. The settings of the domestic hot water temperature and domestic hot water production schedule must be made using this device.

The timed program of the central heating circuit must be set on the QAA73 if there is a single zone, or in relation to the zone controlled by the QAA73 device.

The timed program for the central heating circuit of the other zones can be set directly on the boiler control panel.

See the instructions provided with the QAA73 temperature regulator for the user parameter programming procedure.

QAA73: parameters which can be set by the installer (service)

By pressing the two PROG buttons together for at least three seconds it is possible to access the list of parameters that the installer can display and/or set.

Press either of these buttons to change the parameter to display or change.

Press the [+] or [-] key to change the value displayed.

Press either of the PROG buttons again to save the change.

Press the information button (i) to quit programming.

Here follows a list of the most commonly used parameters:

Line no.	Parameter	Range	Default value
70	HC1 gradient heating curve Selection of central heating circuit temperature curve "kt"	2.5...40	15
72	HC1 max. output Central heating system maximum output temperature	25...85	85
74	Type of building	Light, Heavy	Light
75	Room compensation Activation/deactivation of the influence of the room temperature. If it is deactivated, the outdoor temperature sensor must be installed.	on HC1 on HC2 on HC1+HC2 nil	On HC1
77	Automatic adaptation of the temperature curve "kt" in relation to the room temperature.	On - off	On
78	Opt Start Max Maximum time the boiler is switched on ahead of the timed program to optimise the temperature in the premises.	0...360 min	0
79	Opt Stop Max Maximum time the boiler is switched off ahead of the timed program to optimise the temperature in the premises.	0...360 min	0
80	HC2 gradient heating curve	2.5...40 -- = not active	--
90	DHW Red Setp Minimum temperature of the domestic domestic hot water	10...58	10
91	DHW program Selection of the type of timed program for domestic hot water. 24 h/day = always on PROG HC-1h = as HC1 central heating program less one hour PROG HC = as central heating program PROG DHW = specific domestic hot water program (see also program lines 30-36)	24 h/day TSP HC-1h TSP HC TSP DHW	24 h/day

- Fault messages

In the event of fault, the display panel on the QAA73 shows the flashing symbol . Press the information key (i) to display the error code and a description of the fault (see table on paragraph 3.9).

12.6 CONNECTING THE OUTDOOR TEMPERATURE SENSOR PROBE



The SIEMENS model QAC34 outdoor temperature sensor must be connected to terminals 7-8 of terminal board M2 in figure 12.

The procedures for setting the gradient of the temperature curve “kt” vary depending on the accessories connected to the boiler.

a) Without QAA73 room temperature regulator:

The temperature curve “kt” must be selected by setting parameter H532 as described in section 14 “setting the boiler parameters”.

See graph 2 for selecting the curve referred to a room temperature of 20°C.

The chosen curve can be shifted by pressing the  (2), button (2) on the boiler control panel, and modifying the value displayed by pressing the  and  keys. See graph 3 for curve selection. (The example show in graph 3 refers to the curve Kt=15).

Increase the value displayed if the room temperature required is not reached inside the premises for central heating.

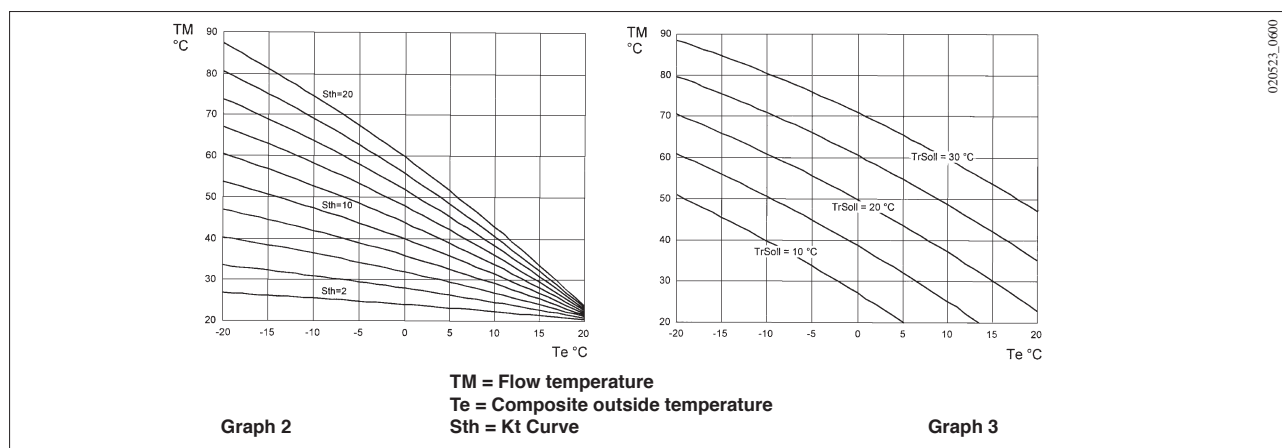

b) With QAA73 room temperature regulator:

The temperature curve “kt” must be selected by setting parameter 70 “HC1 curve” of the QAA73 room temperature control device as described in section 12.4 “QAA73: parameters which can be set by the installation (service) engineer”.

See graph 4 for selecting the curve referred to a room temperature of 20°C.

The curve is shifted automatically on the basis of the room temperature set using the QAA73 climate control. If the system is divided into zones, the temperature curve “kt” relating to the part of the system not controlled by the QAA73 must be selected by setting parameter H532 as described in section 14 “setting the boiler parameters”.

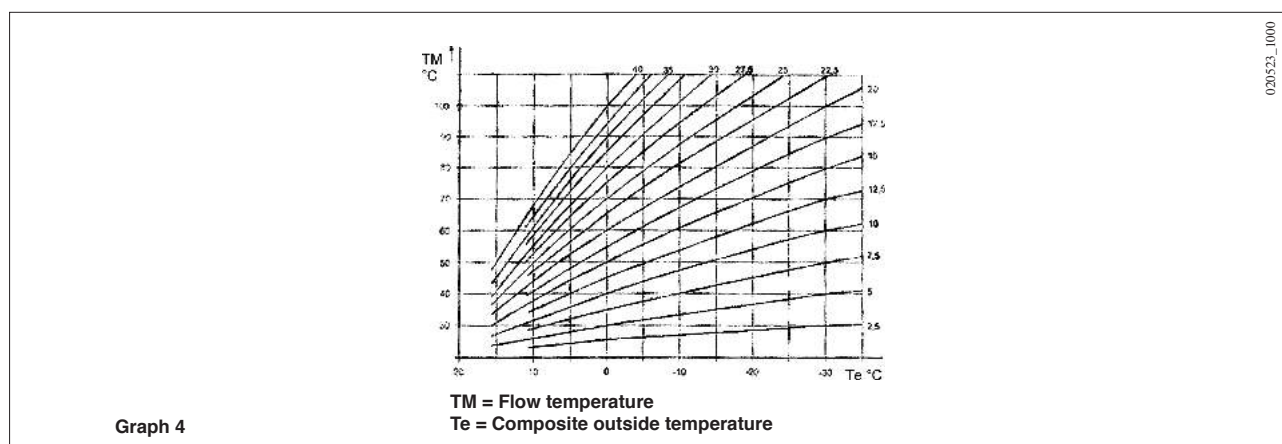

c) With AGU2.500 for control of a low temperature system:

Refer to the instructions provided with the AGU2.500 accessories for connection and control of a variable temperature zone.

13. ADJUSTING THE GAS VALVES

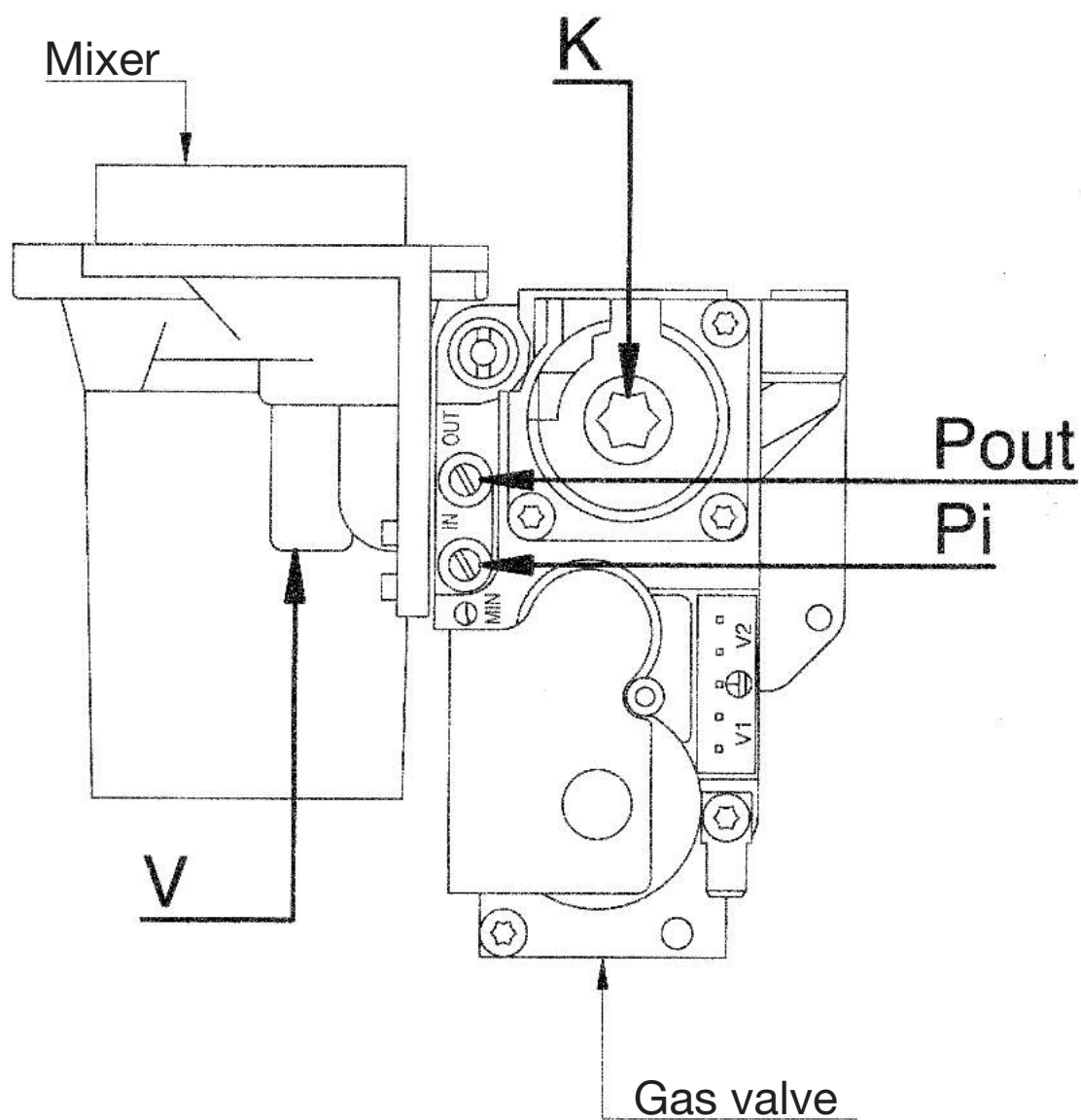





0712_0912 / CT_0754

LEGEND:

- Pi:** Gas supply pressure connection point
- P out:** Pressure connection point for measurement of the OFFSET
- V:** Gas flow adjuster screw
- K:** OFFSET adjuster screw

Figure 14

Proceed as follows to adjust the single gas valve:

- Insert the flue analysis probe into the flue sampling hole as instructed in section 17 (figure 17).
- Press and hold the  and  keys on the control panel simultaneously for 7 seconds until the ► symbols appear on the display in the position shown in figures 15a and 15b  . You are now in 'calibration mode'.
- Press the  key to set the maximum heat output, with the display showing 100% (figure 15a).

Caution: in the event of the boiler failing to ignite, or when replacing the mixer / gas valve group, the recommended procedure is to tighten the adjuster screw (V) fully and then back off 10 turns for natural gas (G20) and 5 turns for propane gas (LPG), repeating the steps described below.

- Turn the adjuster screw **V** on the gas valve until you achieve the CO₂ levels shown in table 2.1 for natural gas (G20) and in table 2.2 for propane (LPG):
 - Turn the screw anti-clockwise to increase the CO₂ level.
 - Turn the screw clockwise to decrease the CO₂ level.
- Press the  key to set the minimum heat output, with the display showing 0% (figure 13b).
- Remove the protection cap and turn the adjuster screw **K** on the gas valve until you achieve the CO₂ levels shown in table 2:
 - Turn the screw clockwise to increase the CO₂ level.
 - Turn the screw anti-clockwise to decrease the CO₂ level.

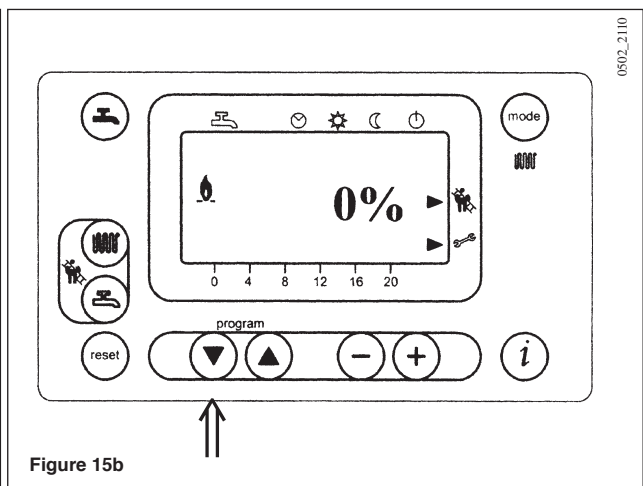
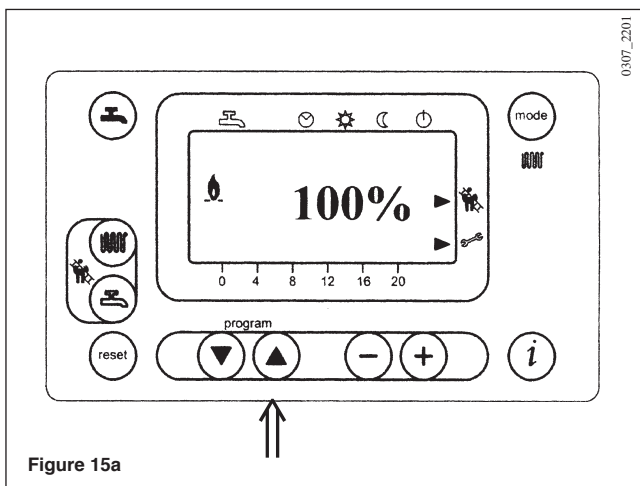

GAS CONVERSION

IMPORTANT: in the event of converting the boiler from natural gas (G20) to propane (LPG), the following operation must be carried out before proceeding to adjust the gas valve as described above:

- Screw 5 turns the adjuster screw (V).
- Set parameters **H536 - H541 - H608 - H609 - H610 - H611 - H612 - H613** by way of the display on the control panel.

The values to be set are given in tables 2.1 and 2.2. The programming methods are described in chapter 14.

Gas consumption at 15 °C 1013 mbar Gas G20 - 2H - 20 mbar		50	70
PCI	MJ/m ³	34,02	34,02
Consumption at max. heat output	m ³ /h	4,91	7,08
Consumption at min. heat output	m ³ /h	1,29	1,46
CO ₂ max. heat output	%	8,7	8,9
CO ₂ min. heat output	%	8,4	8,4
Parameters H536-H613 (rpm) at maximum power		6100	6400
Parameters H541-H610 (pwm %) at maximum power		85	100
Parameter H612 (rpm) at minimum power		1700	1450
Parameter H609 (pwm) at minimum power		13,5	11
Parameter H611 (rpm) ignition load		2600	2500
Parameter H608 (pwm) ignition load		20	18

Table 2.1

Gas consumption at 15 °C 1013 mbar Gas G31 - 3P - 37 mbar		50	70
PCI	MJ/kg	46,34	46,34
Consumption at max. heat output	kg/h	3,6	5,2
Consumption at min. heat output	kg/h	0,95	1,54
CO ₂ max. heat output	%	10,2	10,2
CO ₂ min. heat output	%	9,8	9,8
Parameters H536-H613 (rpm) at maximum power		5700	6000
Parameters H541-H610 (pwm %) at maximum power		75	100
Parameter H612 (rpm) at minimum power		1600	1900
Parameter H609 (pwm) at minimum power		13	14
Parameter H611 (rpm) ignition load		3800	3800
Parameter H608 (pwm) ignition load		30	30

Table 2.2

14. SETTING THE BOILER PARAMETERS

The boiler parameters may only be modified by professionally qualified staff proceeding as follows:

- Press the \odot \ominus keys on the boiler's front panel together for about 3 s until the parameter H90 appears on the display;
- Press the \odot \ominus keys to select the parameter for modification;

- c) Press the ⊖ and ⊕ keys to modify the parameter;
d) Press the ⓘ key to exit the programming function.

The following are the parameters generally used:

Parameter N.	Description	Factory setting
H90	Minimum D.H.W. temperature setting (°C).	10
H91	D.H.W. activation program (0=active; 1=not active)	1
H505	Maximum temperature (°C) of the central heating circuit HC1 corresponding to: - the main circuit in systems with just one zone; - the circuit of the zone where the QAA73 room temperature control device is installed in case of systems with more than one high-temperature zone; - the high temperature zone circuit in mixed systems and if the SIEMENS AGU2.500 accessory is used.	80
H507	Maximum temperature (°C) of the central heating circuit HC2 of a system with more than one zone, corresponding to the circuit of the low-temperature zone if the SIEMENS AGU2.500 accessory is used.	80
H516	Automatic Summer / Winter switching temperature (°C).	20
H532	Selection of temperature curve of central heating circuit HC1 (see Graph 2)	15
H533	Selection of temperature curve of central heating circuit HC2 (see Graph 2)	15
H608	PWM (%) Setting: Ignition load	See table 2
H611	Speed setting (rpm) : Ignition load	
H609	PWM Setting (%) : minimum power	
H541-H610	PWM Setting (%) : maximum power Central heating / Domestic hot water	
H612	Speed setting (rpm) : minimum power	
H536-H613	Speed setting (rpm) : maximum power Central heating / Domestic hot water	
H544	Pump post-circulation time in central heating mode (min)	10
H545	Burner operating pause time between two start-ups (s)	180
H552 (*)	Hydraulic system setting (see instructions provided with the SIEMENS AGU2.500 accessory) H552 = 50 with AGU2.500 and QAA73 H552 = 80 with RVA 47	2
H553 (*)	Configuration of heating circuits H553 = 12 with AGU2.500	21
H615	Programmable function:	9
H632 (*)	Heat demand to be supported by the system pump H632 = 00001111 with AGU2.500 and RVA 47	00001100
H641	Fan overrun time setting (s)	10
H657	Setpoint of autonomous ANTILEGIONELLA function 60...80 °C = setting temperature range 0 = function inactive	0

Table 3

(*) For these parameters see section 10.1 - 10.2 - 10.3 (hydraulic system).

If the electronic circuit board is replaced, make sure that the parameters set are those specific to the boiler model, as indicated in the documentation available from the authorised Service Centre.

15. CONTROL AND OPERATION DEVICES

The boiler has been designed in full compliance with European reference standards and in particular is equipped with the following:

- **Overheat safety thermostat**

This thermostat interrupts the gas flow to the main burner in case the water contained in the circuit has overheated. Under these conditions the boiler locks out and can only repeat the ignition procedure by pressing of the reset button on the boiler after the cause of the trip has been rectified.

It is strictly forbidden to disable this safety device.

- **Flue thermostat**

This device, positioned on the flue inside the boiler, interrupts the flow of gas to the burner if the temperature exceeds 90 °C. After verifying the cause of the trip, press the reset button positioned on the thermostat itself, then press the reset button on the boiler.

It is forbidden to disenable this safety device

- **Flame ionization detector**

The flame sensing electrode guarantees safety of operation in case of gas failure or incomplete interlighting of the main burner.

Under such conditions the boiler is locked out.

You must press the reset button on the boiler to restore the normal operating conditions.

- **Pump overrun**

The electronic control system keeps the pump operating for 10 minutes in central heating mode after the room temperature thermostat has switched off the main burner.

- **Frost protection device**

The boilers electronic management includes a “frost protection” function in the central heating system which operates the burner to reach a heating flow temperature of 30°C when the system heating flow temperature drops below 5 °C.

This function is enabled as long as the boiler is connected to the a.c. power supply gas supplies and the pressure in the system is as specified.

- **Pump-blocking prevention**

In case there is no call for heat either from the central heating system or from the DHW system for 24 hours continuous the pump will automatically switch on for 10 seconds.

- **Hydraulic pressure sensor**

This device enables the main burner only to be switched on if the system pressure is over 0.5 bar.

- **Gas pressure switch**

This device enables the burner only to be switched on if the gas pressure is over 12 mbar.

16. POSITIONING OF THE IGNITION AND FLAME SENSING ELECTRODE

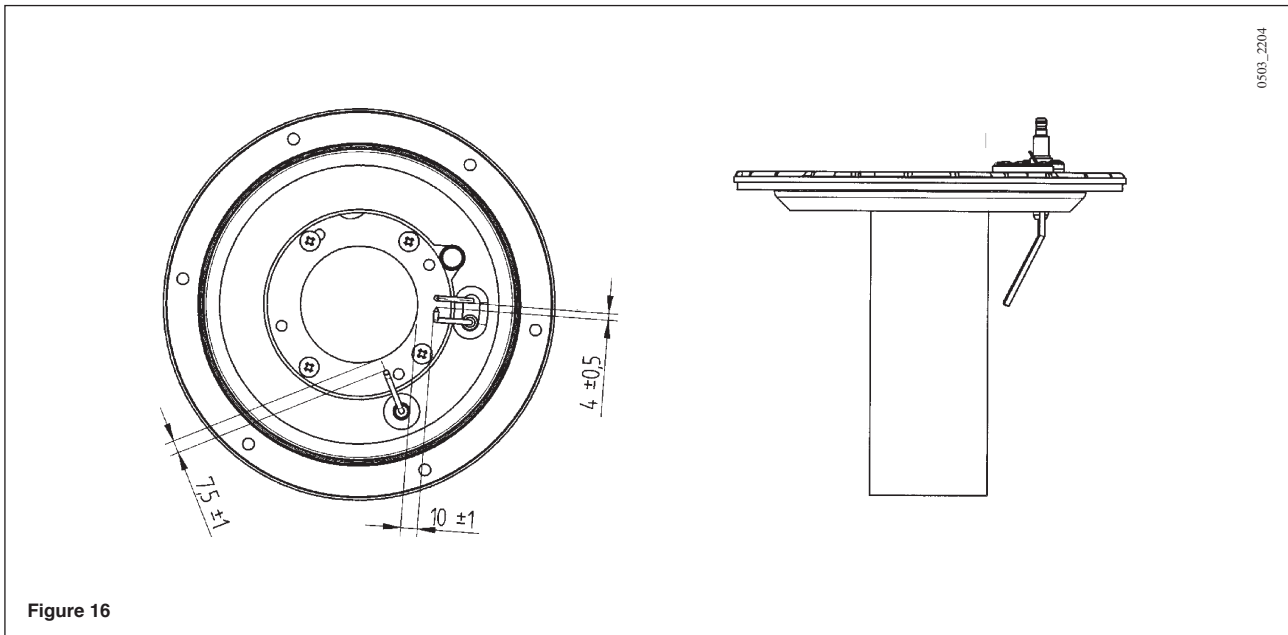

17. CHECK OF COMBUSTION PARAMETERS

Drill a hole in the flue at a distance from the boiler equivalent to twice the diameter of the flue to measure combustion efficiency and combustion flue composition in accordance with the rules in force. Use this hole to measure the following parameters:

- Combustion flue temperature
- Oxygen (O₂) or carbon dioxide (CO₂) concentration.
- Carbon monoxide (CO) concentration.

Measure the temperature of combustion air near the air inlet to the boiler. The necessary hole must be made by the technician responsible for the heating system when the system is first started up, and must then be closed to ensure that the flue remains properly sealed during normal operation.

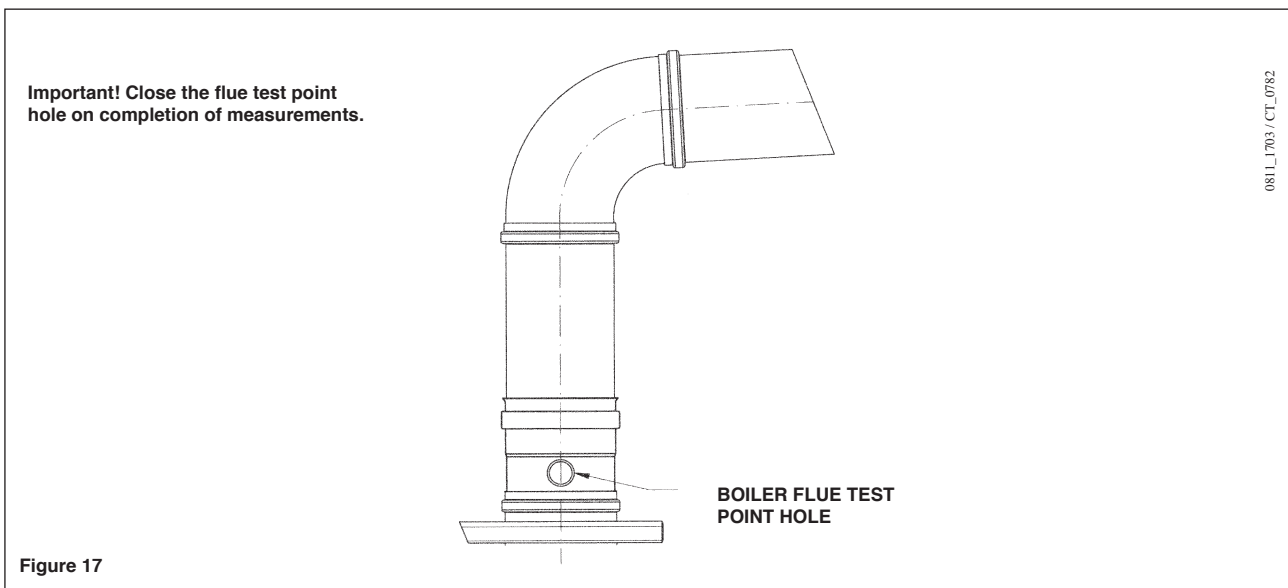

18. ACTIVATING THE CHIMNEY SWEEP FUNCTION

To facilitate measurement of the combustion efficiency and improve the cleanliness of the production products, the chimney sweep function can be activated by proceeding as described below:

- 1) Press the (2-3) together until the pointer “▶” appears on the display alongside the symbol (about 3 seconds but no more than 6 seconds). In these conditions, the boiler operates at the maximum heat output in central heating mode.
- 2) Press either of the buttons to exit the function

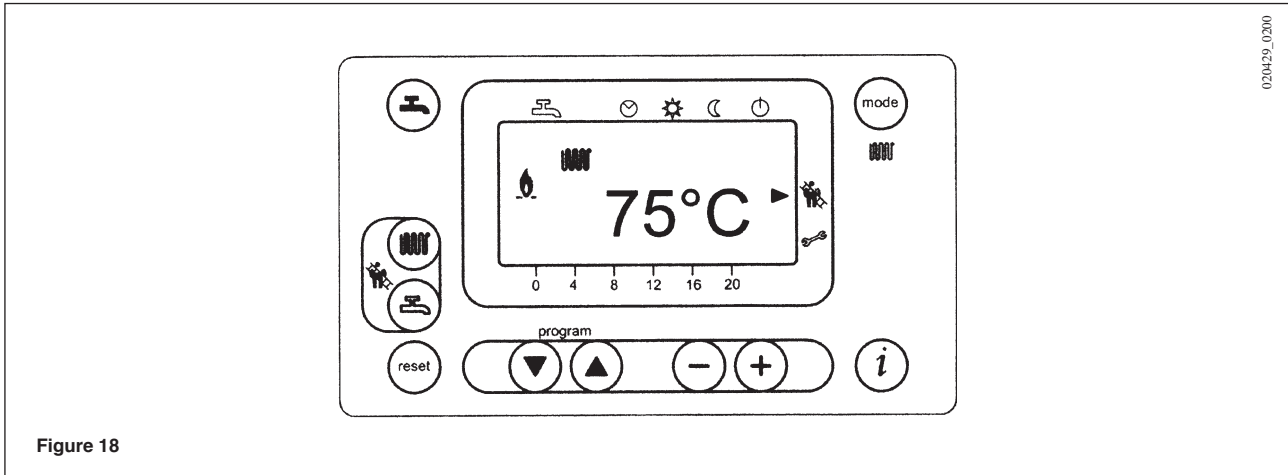

19. ANNUAL SERVICE

To ensure the boiler operates at peak efficiency, the following checks must be performed every year:

- Check on the appearance and tightness of the gas and combustion circuit gaskets;
- Check on the condition and position of the ignition and flame sensing electrodes (see section 16);
- Check on the condition of the burner and its fixing to the aluminium flange;
- Check for any dirt in the combustion chamber. Use a vacuum-cleaner for this cleaning operation;
- Check that the gas valve is calibrated correctly (see section 13);
- Check that there is no dirt in the siphon;
- Check on the central heating system pressure;
- Check on the central heating expansion vessel pressure.

20. BOILER SCHEMATIC

CT_0817 / 0906_2401

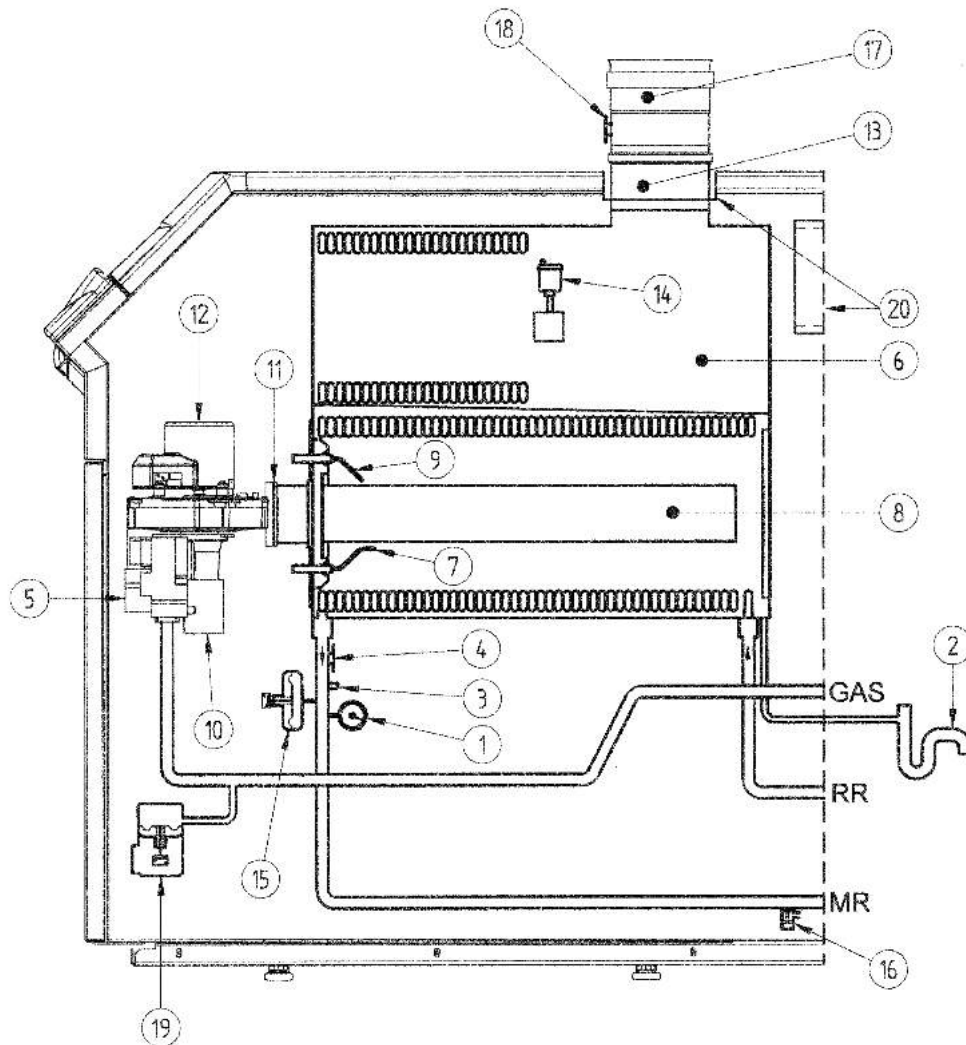
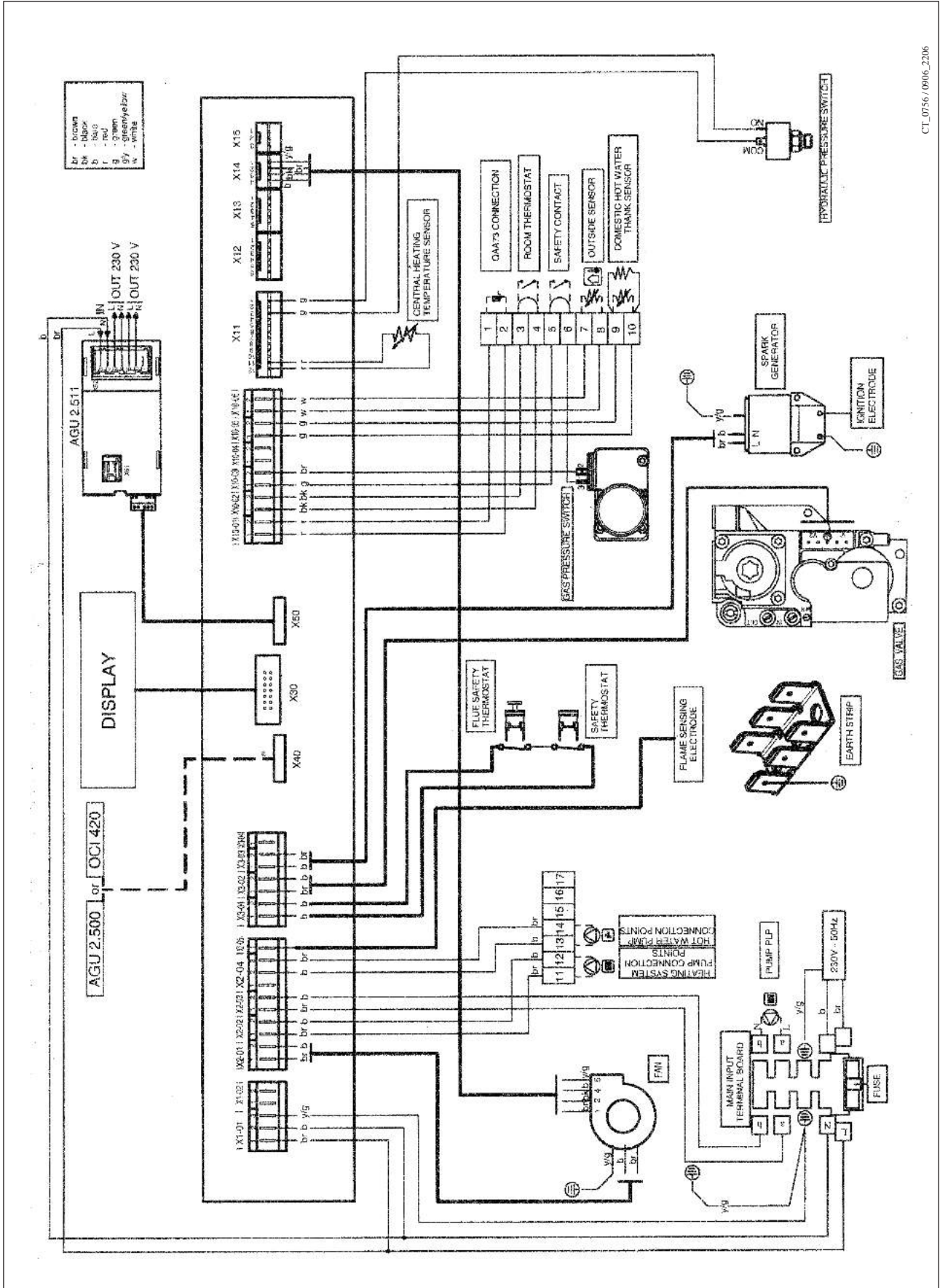

Figure 19

Key:

- 1 Water pressure gauge
- 2 Siphon (condensate)
- 3 Central heating ntc sensor
- 4 105°C overheat safety thermostat
- 5 Gas valve
- 6 Heat exchanger
- 7 Flame detector electrode (ionisation probe)
- 8 Burner
- 9 Ignition electrode
- 10 Mixer with venturi
- 11 Air/gas diaphragm
- 12 Fan
- 13 Flue joint
- 14 Automatic air vent
- 15 Hydraulic pressure sensor
- 16 Boiler drain point
- 17 Joint flue with flue thermostat
- 18 Flue thermostat
- 19 Gas pressure switch
- 20 Seat of air intake

21. ILLUSTRATED WIRING DIAGRAM



CT_0756 / 0906_2206

22. TECHNICAL DATA

Boiler model FS		50	70
Category		II _{2H3P}	II _{2H3P}
Maximum heat input (net/gross)	kW	46,4-51	67-73,7
Minimum heat input (net/gross) (G20)	kW	12,2-13,4	13,8-15,2
Minimum heat input (net/gross) (G31)	kW	12,2-13,4	19,9-21,9
Maximum heat output 75/60°C	kW	45	65
	kcal/h	38.700	55.900
Maximum heat output 50/30°C	kW	48,7	70,3
	kcal/h	41.882	60.458
Minimum heat output 75/60°C (G20)	kW	11,8	13,4
	kcal/h	10.148	11.524
Minimum heat output 75/60°C (G31)	kW	11,8	19,3
	kcal/h	10.148	16.598
Minimum heat output 50/30°C (G20)	kW	12,8	14,5
	kcal/h	11.008	12.470
Minimum heat output 50/30°C (G31)	kW	12,8	20,9
	kcal/h	11.008	17.974
Useful efficiency according to 92/42/CEE directive	—	★★★★	★★★★
Central heating system max. pressure	bar	4	4
Heating circuit temperature range	°C	25÷80	25÷80
Flue type	—	B23 - B23P - C53*	
Flue duct diameter	mm	80	80
Max. flue mass flow rate	kg/s	0,022	0,031
Min. flue mass flow rate	kg/s	0,006	0,007
Max. flue temperature	°C	72	73
NOx class	—	5	5
Type of gas used	—	G20	G20
	—	G31	G31
Natural gas feeding pressure 2H	mbar	20	20
Propane gas feeding pressure 3P	mbar	37	37
Gas Consumption (NG)	m ³ /hr	4,91	7,08
Minimum Operating Pressure	Bar	1	1
High Level Ventilation to BS6644 boiler room	cm ²	92,8	113,4
Low Level Ventilation to BS6644 boiler room	cm ²	185,6	226,8
Mechanical inlet to BS6644	m ³ /sec	0,038	0,056
Water Flow at 20°K Δt	lit/sec	0,053	0,77
Hydraulic Resistance at 20°K Δt	kPa	25	25
Cold Feed Size to BS6644	mm	25	25
Safety valve size to BS6644 (open vent)	mm	19	19
Open vent BS6644	mm	32	32
Maximum Flow Temperature	°C	72	73
Water Content	lit	5,1	6,5
Power supply voltage	V	230	230
Power supply frequency	Hz	50	50
Rated power supply	W	900	110
Net weight	kg	60	68
Dimensions	height	mm	850
	width	mm	450
	depth	mm	621

* C53 (only with air intake kit)

Commercial sales technical & service enquiries

Tel: 0845 070 1055
Fax: 0845 070 1059
Sales hotline: 0845 070 1056
Technical helpline: 0845 070 1057
Service hotline: 0845 070 1058
e-mail: potterton.commercial@baxigroup.com
web: www.pottertoncommercial.co.uk

Spares

Potterton Commercial spares are available nationwide through the interpart network of approved stockists. Alternatively please contact:-

Interpart

Brooks House
Coventry Road
Warwick CV34 4LL
Tel: 0844 871 1540

Applications & Installations

Our experienced technical support team are available to offer advice on any aspect of heating system design and boiler installation.

Please contact: 0845 070 1057

Commercial service offices

Our service organisation covers the whole of the UK to look after your needs for all Potterton Commercial products.

Our service office offers a wide range of specialised services including:

- Burner commissioning for all fuels
- Boiler service contracts
- Breakdown and repair services
- Burner and boiler replacement
- Oil/gas conversions
- Water treatment and descaling
- Packaged units

All descriptions and illustrations contained within this leaflet have been carefully prepared, but we reserve the right to make changes and improvements in our products which may affect the accuracy of the information in this leaflet.

PART OF BDR THERMEA

Baxi Commercial Division

Wood Lane, Erdington,
Birmingham B24 9QP
Email: potterton.commercial@baxigroup.com
www.pottertoncommercial.co.uk

Sales:

0845 070 1056

Technical:

0845 070 1057

POTTERTON
C O M M E R C I A L

heating specialists