

RL/M SERIES

The RL/M series of burners covers a firing range from 166 to 2431 kW, and they have been designed for use in hot or superheater water boilers, hot air or steam generators, diathermic oil boilers.

Operation can be "two stage progressive" or, alternatively, "modulating" with the installation of a PID logic regulator and respective probes. RL/M series burners guarantees high efficiency levels in all the various applications, thus reducing fuel consumption and running costs. Optimisation of sound emissions is guaranteed by the use of fans with forward inclined blades and sound deadening material incorporated in the air suction circuit.

The exclusive design ensures reduced dimensions, simple use and maintenance. A wide range of accessories guarantees elevated working flexibility.

RL 28/M	90/166 ÷ 332	kW
RL 38/M	101/237 ÷ 450	kW
RL 50/M	130/296 ÷ 593	kW
RL 70/M	261/474 ÷ 1043	kW
RL 100/M	332/711 ÷ 1482	kW
RL 130/M	498/948 ÷ 1779	kW
RL 190/M	534/1423 ÷ 2431	kW



FIRING RATES

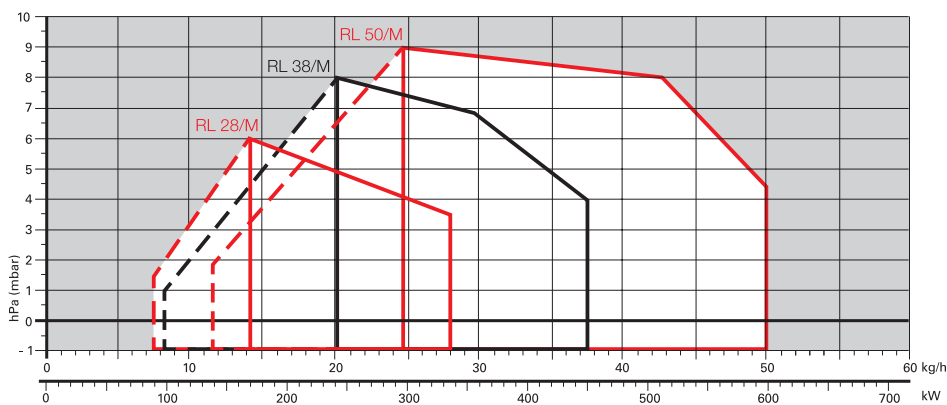

Useful working field for choosing the burner

Modulation range

Test conditions conforming to EN267
 Temperature: 20°C
 Pressure: 1013,5 mbar
 Altitude: 0 m a.s.l.

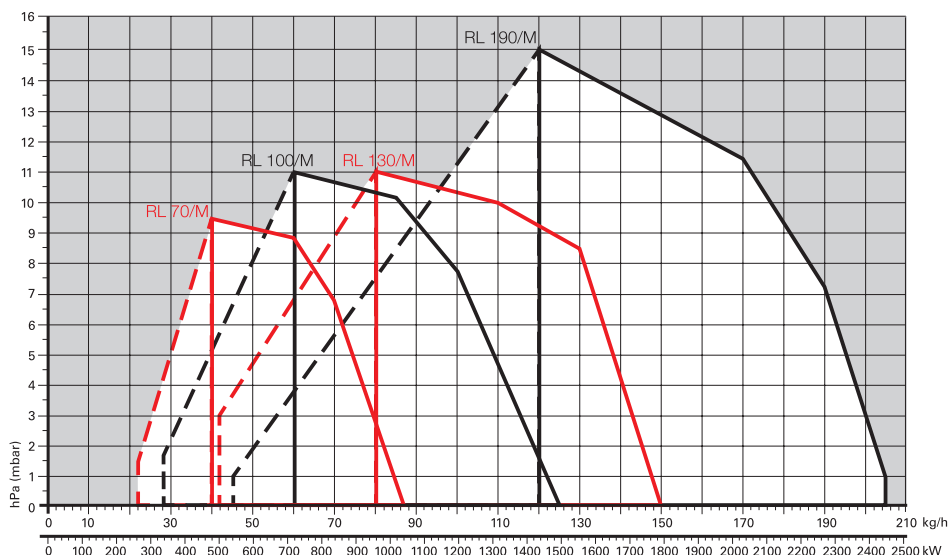

Modulating Light Oil Burners

RL/M SERIES

Overall dimensions (mm)

BURNER

RL 28/M - 38/M - 50/M

RL 70/M - 100/M - 130/M - 190/M

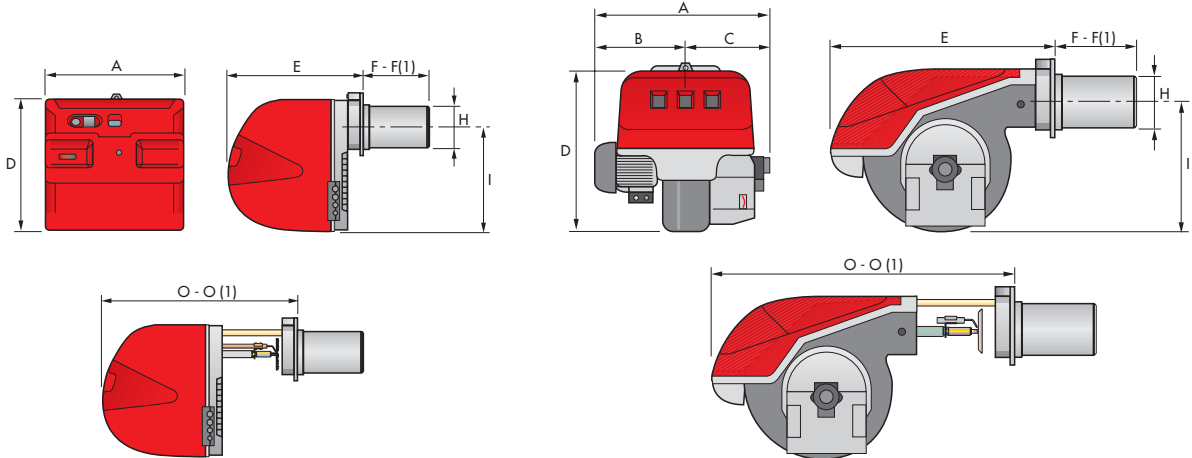

MODEL	A	B	C	D	E	F - F (1)	H	I	O - O (1)
▶ RL 28/M	476	-	-	474	468	241 - 351	140	352	672 - 807
▶ RL 38/M	476	-	-	474	468	241 - 351	140	352	672 - 807
▶ RL 50/M	476	-	-	474	468	241 - 351	152	352	672 - 807
▶ RL 70/M	663	296	367	555	680	272 - 385	179	430	951 - 1086
▶ RL 100/M	679	312	367	555	680	272 - 385	179	430	951 - 1086
▶ RL 130/M	705	338	367	555	680	272 - 385	189	430	951 - 1086
▶ RL 190/M	813	366	447	555	712	370	222	430	1166

(1) Length with extended combustion head.

BURNER - BOILER MOUNTING FLANGE

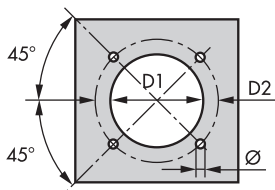

MODEL	D1	D2	Ø
▶ RL 28/M	160	224	M8
▶ RL 38/M	160	224	M8
▶ RL 50/M	160	224	M8
▶ RL 70/M	185	275 - 325	M12
▶ RL 100/M	185	275 - 325	M12
▶ RL 130/M	195	275 - 325	M12
▶ RL 190/M	230	325 - 368	M16

PACKAGING

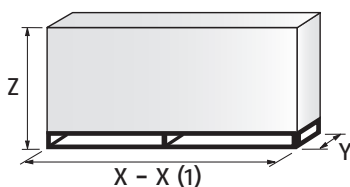

MODEL	X - X (1)	Y	Z	kg
▶ RL 28/M	872	540	550	39
▶ RL 38/M	872	540	550	41
▶ RL 50/M	872	540	550	42
▶ RL 70/M	1150	792	600	65
▶ RL 100/M	1150	792	600	68
▶ RL 130/M	1150	792	600	71
▶ RL 190/M	1200	800	850	95

(1) Length with extended combustion head.

RL/M SERIES

Specification

DESIGNATION OF SERIES

Series : R									
Fuel : S Natural gas									
L Light oil									
LS Light oil / Natural gas									
N Heavy oil									
Size									
Operation : /1 One stage									
... Two stage									
/M Modulating									
/E Electronic cam									
/P Proportioning air/gas valve									
/EV Electronic cam predisposed for variable speed (with inverter)									
Emission : ... Class 1 EN267 - EN676									
MZ Class 2 EN267 - EN676									
BLU Class 3 EN267 - EN676									
MX Class 2 EN267									
Class 3 EN676									
Head : TC Standard head									
TL Extended head									
Flame control system :									
FS1 Standard (1 stop every 24 h)									
FS2 Continuous working (1 stop every 72 h)									
Electrical supply to the system :									
1/230/50 1/230V/50Hz									
3/230/50 3/230V/50Hz									
3/400/50 3N/400V/50Hz									
3/230-400/50 3/230V/50Hz - 3N/400V/50Hz									
3/220/60 3/220V/60Hz									
3/380/60 3N/380V/60Hz									
3/220-380/60 3/220V/60Hz - 3N/380V/60Hz									
Auxiliary voltage :									
230/50-60 230V/50-60Hz									
110/50-60 110V/50-60Hz									
ID : Differential switch									
R	L	50	/M		TC	FS1	3/230-400/50	230/50-60	
BASIC DESIGNATION					EXTENDED DESIGNATION				

Specification

STATE OF SUPPLY

Monoblock forced draught oil burners, two stage progressive or modulating operation with a kit, made up of:

- Air suction circuit lined with sound-proofing material
- Fan with reverse curve blades (forward curve blades on the 190/M model)
- Air damper for air setting and automatic oil output regulator controlled by a servomotor with variable cam
- Combustion head, that can be set on the basis of required output
- Gears pump for high pressure fuel supply
- Valve unit with a double oil safety valve on the output circuit and safety valve on the return circuit; double safety valve on the return circuit for models RL 100/M, RL 130/M, RL 190/M and for all models in the TRD-72, NBN version
- Safety oil pressure switch
- Minimum oil pressure switch in the output circuit for the TRD-72, NBN versions
- Photocell for flame detection
- Burner safety control box
- Burner on/off switch
- Flame inspection window
- Manual or automatic output increase/decrease switch
- Slide bars for easier installation and maintenance
- Protection filter against radio interference
- IP 44 electric protection level.

Standard equipment:

- 2 flexible pipes for connection to the oil supply network
- 2 gaskets for the flexible pipes
- 2 nipples for connection to the pump
- 4 screws for fixing the burner flange to the boiler
- 1 thermal screen
- Wiring loom fittings for electrical connections
- 2 slide bar extensions (for the extended head models and the RL 190/M model)
- Instruction handbook for installation, use and maintenance
- Spare parts catalogue.

RL/M SERIES

Available models

CODE	MODEL						HEAT OUTPUT		TOTAL ELECTRICAL POWER (kW)	CERTIFICATION	NOTE
							(kW)	(kg/h)			
3471002	RL 28/M	TC	FS1	1/230/50	230/50-60	90/166-332	7,5/14-28	0,4	CE 1001/R		
3471003	RL 28/M	TL	FS1	1/230/50	230/50-60	90/166-332	7,5/14-28	0,4	CE 1001/R		
3471080	RL 28/M	TC	FS1	1/220-230/60	230/50-60	90/166-332	7,5/14-28	0,4	CE 1001/R		
3471081	RL 28/M	TL	FS1	1/220-230/60	230/50-60	90/166-332	7,5/14-28	0,4	CE 1001/R		
3471402	RL 38/M	TC	FS1	3/230-400/50	230/50-60	101/237-450	8,5/20-38	0,6	CE 1001/R		
3471403	RL 38/M	TL	FS1	3/230-400/50	230/50-60	101/237-450	8,5/20-38	0,6	CE 1001/R		
3471480	RL 38/M	TC	FS1	3/208-230/380-460/60	230/50-60	101/237-450	8,5/20-38	0,66	CE 1001/R		
3471481	RL 38/M	TL	FS1	3/208-230/380-460/60	230/50-60	101/237-450	8,5/20-38	0,66	CE 1001/R		
3471602	RL 50/M	TC	FS1	3/230-400/50	230/50-60	130/296-593	11/25-50	0,8	CE 1001/R		
3471603	RL 50/M	TL	FS1	3/230-400/50	230/50-60	130/296-593	11/25-50	0,8	CE 1001/R		
3471680	RL 50/M	TC	FS1	3/208-230/380-460/60	230/50-60	130/296-593	11/25-50	0,66	CE 1001/R		
3471681	RL 50/M	TL	FS1	3/208-230/380-460/60	230/50-60	130/296-593	11/25-50	0,66	CE 1001/R		
3477012	RL 70/M	TC	FS1	3/230-400/50	230/50-60	261/474-1043	22/40-88	1,4	CE-0440/B		
3477013	RL 70/M	TL	FS1	3/230-400/50	230/50-60	261/474-1043	22/40-88	1,4	CE-0440/B		
3477080	RL 70/M	TC	FS1	3/208-230/380-460/60	230/50-60	261/474-1043	22/40-88	1,4	-		
3477081	RL 70/M	TL	FS1	3/208-230/380-460/60	230/50-60	261/474-1043	22/40-88	1,4	-		
3477022	RL 70/M	TC	FS2	3/230-400/50	230/50-60	261/474-1043	22/40-88	1,4	CE-0440/B		
3477023	RL 70/M	TL	FS2	3/230-400/50	230/50-60	261/474-1043	22/40-88	1,4	CE-0440/B		
3477212	RL 100/M	TC	FS1	3/230-400/50	230/50-60	332/711-1482	28/60-125	2,1	CE-0440/B		
3477213	RL 100/M	TL	FS1	3/230-400/50	230/50-60	332/711-1482	28/60-125	2,1	CE-0440/B		
3477280	RL 100/M	TC	FS1	3/208-230/380-460/60	230/50-60	332/711-1482	28/60-125	2,1	-		
3477281	RL 100/M	TL	FS1	3/208-230/380-460/60	230/50-60	332/711-1482	28/60-125	2,1	-		
3477222	RL 100/M	TC	FS2	3/230-400/50	230/50-60	332/711-1482	28/60-125	2,1	CE-0440/B		
3477223	RL 100/M	TL	FS2	3/230-400/50	230/50-60	332/711-1482	28/60-125	2,1	CE-0440/B		
3477412	RL 130/M	TC	FS1	3/230-400/50	230/50-60	498/948-1779	42/80-150	2,6	CE-0440/B		
3477413	RL 130/M	TL	FS1	3/230-400/50	230/50-60	498/948-1779	42/80-150	2,6	CE-0440/B		
3477480	RL 130/M	TC	FS1	3/208-230/380-460/60	230/50-60	498/948-1779	42/80-150	2,6	-		
3477481	RL 130/M	TL	FS1	3/208-230/380-460/60	230/50-60	498/948-1779	42/80-150	2,6	-		
3477422	RL 130/M	TC	FS2	3/230-400/50	230/50-60	498/948-1779	42/80-150	2,6	CE-0440/B		
3477423	RL 130/M	TL	FS2	3/230-400/50	230/50-60	498/948-1779	42/80-150	2,6	CE-0440/B		
3477811	RL 190/M	TC	FS1	3/400/50	230/50-60	534/1423-2431	45/120-205	5,5	CE-0440/B		
20011022	RL 190/M	TC	FS1	3/230/50	230/50-60	534/1423-2431	45/120-205	5,5	CE-0440/B		
3477880	RL 190/M	TC	FS1	3/460/60	220/60	534/1423-2431	45/120-205	5,5	-		
20011029	RL 190/M	TC	FS1	3/220/60	220/60	534/1423-2431	45/120-205	5,5	-		
3477822	RL 190/M	TC	FS2	3/400/50	230/50-60	534/1423-2431	45/120-205	5,5	CE-0440/B		
20011025	RL 190/M	TC	FS2	3/230/50	230/50-60	534/1423-2431	45/120-205	5,5	CE-0440/B		
20052628	RL 190/M	TL	FS1	3/400/50	230/50-60	534/1423-2431	45/120-205	5,5	CE-0440/B		

Net calorific value: 11,8 kWh/kg - 10200 kcal/kg - Viscosity at 20°C: 4-6 mm²/s (cSt).

The burners of RL/M series are in according to 2004/108 - 2006/95 - 2006/42 EC Directive and EN 267 Norm.

Burner accessories

Return nozzles type A3, A4 45°

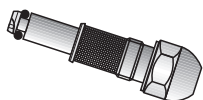

The following list shows the features and codes on the basis of the maximum required fuel output.

NOTE: each burner needs N° 1 nozzle.

BURNER	RATED OUTPUT kg/h	A3 NOZZLE CODE	A4 NOZZLE CODE
▶ RL 28/M	15	3009850	-
▶ RL 28/M - 38/M	20	3009851	-
▶ RL 28/M - 38/M - 50/M	30	3009852	-
▶ RL 38/M - 50/M - 70/M	40	3009853	20067277
▶ RL 50/M - 70/M	50	3009854	20067279
▶ RL 70/M - 100/M	60	3009855	20067281
▶ RL 70/M - 100/M	70	3009856	20067283
▶ RL 100/M - 130/M	80	3009857	20067284
▶ RL 100/M - 130/M	90	3009858	20067285
▶ RL 100/M - 130/M	100	3009859	20067286
▶ RL 130/M	110	3009860	20067287
▶ RL 130/M - 190/M	120	3009861	20067288
▶ RL 130/M - 190/M	130	3009862	20067289
▶ RL 190/M	140	3009863	20067290
▶ RL 190/M	150	20059496*	20067290
▶ RL 190/M	160	3009864	20067293
▶ RL 190/M	180	3009865	20067295
▶ RL 190/M	200	3009866	20067297

* 60° Angle

Extended head kit

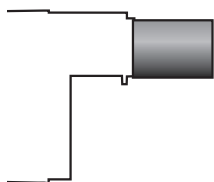

"Standard head" burners can be transformed into "extended head" versions, by using the special kit.

BURNER	STANDARD HEAD LENGTH (mm)	EXTENDED HEAD LENGTH (mm)	KIT CODE
▶ RL 28/M	241	351	3010120
▶ RL 38/M	241	351	3010121
▶ RL 50/M	241	351	3010122
▶ RL 70/M	272	385	3010159
▶ RL 100/M	272	385	3010160
▶ RL 130/M	272	385	3010161
▶ RL 190/M	370	526	20058084

Spacer kit

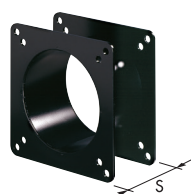

If burner head penetration into the combustion chamber needs reducing, varying thickness spacers are available, as given in the following list.

BURNER	SPACER THICKNESS S (mm)	KIT CODE
▶ RL 28/M - 38/M - 50/M	110	3010095
▶ RL 70/M - 100/M - 130/M	135	3010129
▶ RL 190/M	102	3000722

RL/M SERIES

Burner accessories

Sound proofing box

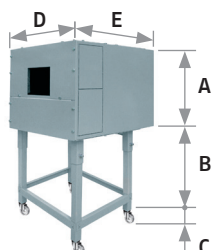

If noise emission needs reducing even further, sound-proofing boxes are available. In case of generator heights, where a lower dimension "B" is required, ask for the Box Support Kit code 20065135. The useful dimensions are 40 mm less than the total dimensions indicated in the table (A, D, E). Not suitable for outdoor use.

BURNER	BOX TYPE	A (mm)	B (mm) min-max	C (mm)	D (mm)	E (mm)	[dB(A)] (*)	BOX CODE
▶ RL 28/M – 38/M – 50/M	C1/3	650	372 – 980	110	690	770	10	3010403
▶ RL 70/M – 100/M – 130/M ▶ RL 190/M	C4/5	850	160 – 980	110	980	930	10	3010404

(*) Average noise reduction according to EN 15036-1 standard

Degasing unit



To solve problem of air in the oil sucked, two versions of degasing unit are available.

BURNER	FILTER	FILTERING DEGREE (µm)	DEGASING UNIT CODE (*)
▶ RL 28/M – 38/M – 50/M – 70/M – 100/M	With filter	50 – 75	3010055
▶ RL 28/M – 38/M – 50/M – 70/M – 100/M	Without filter	-	3010054

(*) Max capability 80 kg/h (more filters are needed for higher flow).

Head kit for "reverse flame chamber"



In certain cases, the use of the burner on reverse flame boilers can be improved by using an additional cylinder.

BURNER	STANDARD HEAD LENGTH WITH CYLINDER (mm)	EXTENDED HEAD LENGTH WITH CYLINDER (mm)	KIT CODE
▶ RL 28/M – 38/M	319	429	3010178
▶ RL 50/M	319	429	3010179
▶ RL 70/M – 100/M	375	488	3010180
▶ RL 130/M	375	488	3010183
▶ RL 190/M	493	-	3010241

Connection flange kit

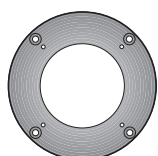

A kit is available for use where the burner opening on the boiler is of excessive diameter.

BURNER	KIT CODE
▶ RL 28/M – 38/M – 50/M	3010138

Modulating Light Oil Burners

RL/M SERIES

Burner accessories

Accessories for modulating operation



To obtain modulating operation, the RL/M series of burners requires a regulator.

BURNER	REGULATOR TYPE	REGULATOR CODE
▶ RL 28/M - 38/M - 50/M RL 70/M - 100/M - 130/M - 190/M	RWF 40	3010212



The relative temperature or pressure probes fitted to the regulator, must be chosen on the basis of the application.

BURNER	PROBE TYPE	RANGE (°C) (bar)	PROBE CODE
▶ RL 28/M - 38/M - 50/M RL 70/M - 100/M - 130/M - 190/M	Temperature PT 100	-100 ÷ 500°C	3010110
	Pressure 4 ÷ 20 mA	0 ÷ 2,5 bar	3010213
	Pressure 4 ÷ 20 mA	0 ÷ 16 bar	3010214
	Pressure 4 ÷ 20 mA	0 ÷ 25 bar	3090873



Depending on the servomotor fitted to the burner, a three-pole potentiometer (1000 Ω) can be installed to check the position of the servomotor.

BURNER	POTENTIOMETER KIT CODE
▶ RL 28/M - 38/M - 50/M	3010109
▶ RL 70/M - 100/M - 130/M - 190/M	3010416