

RIELLO 40 FS SERIES

The Riello 40 FS series of one stage gas burners, is a complete range of products developed to respond to any request for light industrial application. The Riello 40 FS series is available in five different models, with an output ranging from 11 to 220 kW, divided in four different structures.

All the models use the same components designed by Riello for the Riello 40 FS series. The high quality level guarantees safe working.

The Riello 40 FS burners are fitted with a microprocessor - based control box, with diagnostic functions.

In developing these burners, special attention was paid to reducing noise, to the ease of installation and adjustment, to obtaining the smallest size possible to fit into any sort of boiler available on the market.

All the models are approved by the EN 676 European Standard and conform to European Directives for EMC, Low Voltage, Machinery and Boiler Efficiency.

All the Riello 40 FS burners are tested before leaving the factory.



FS3	11 ÷ 35 kW
FS5	23 ÷ 58 kW
FS8	46 ÷ 93 kW
FS10	42 ÷ 116 kW
FS15	81 ÷ 175 kW
FS20	81 ÷ 220 kW

FIRING RATES

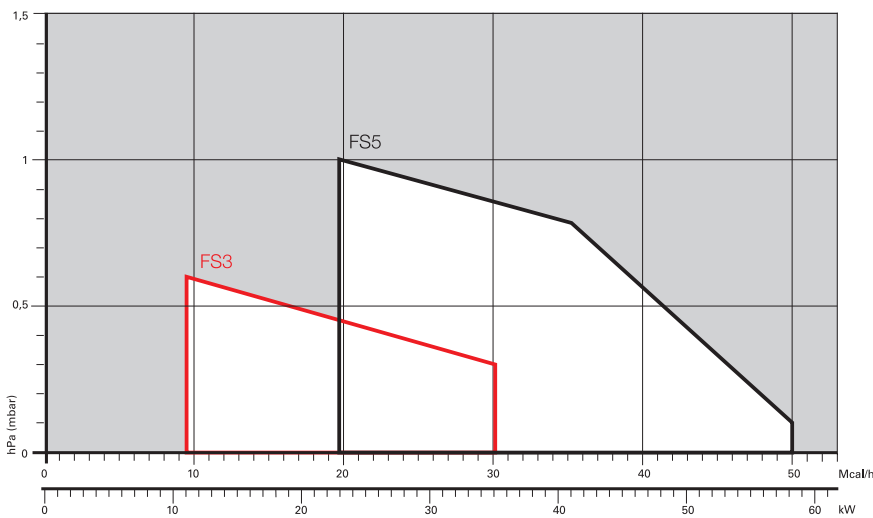

Useful working field for choosing the burner

Test conditions conforming to EN676
 Temperature: 20°C
 Pressure: 1013,5 mbar
 Altitude: 0 m a.s.l.

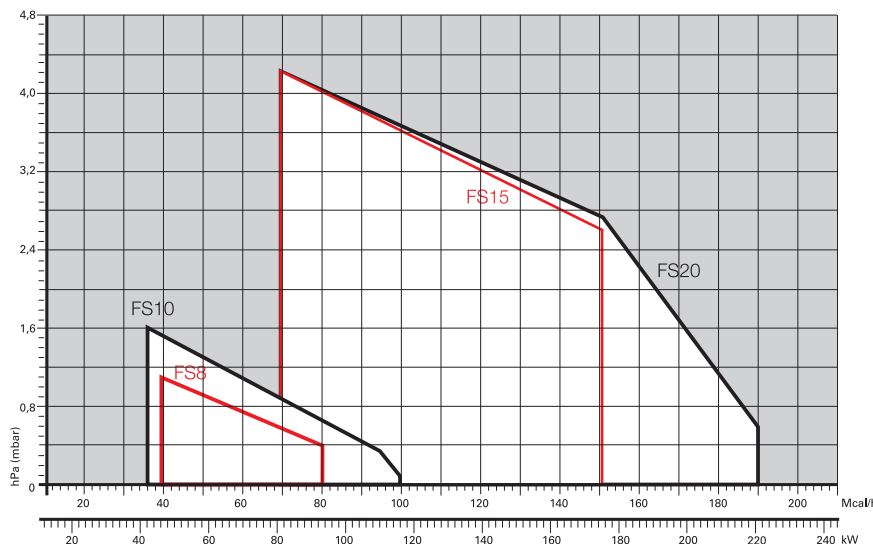

One Stage Gas Burners

RIELLO 40 FS SERIES

Overall dimensions (mm)

BURNER

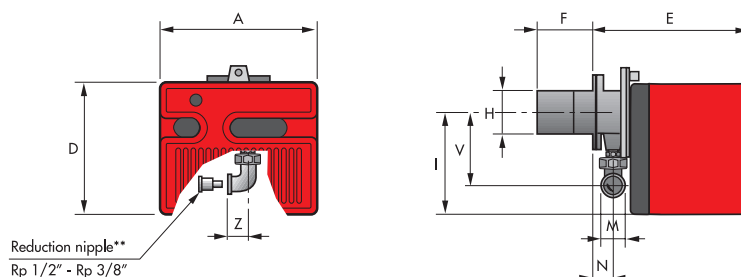

MODEL	A	D	E	F	H	I	M	N	V	Z
▶ FS3	252	215	230	100	91	165	Rp 3/8"*	37	132	25
▶ FS5	272	233	295	100	91	180	Rp 1/2"	48	138	28
▶ FS8	305	262	347	110	105	204	Rp 3/4"	61	142	33
▶ FS10	305	262	346	110	105	204	Rp 3/4"	61	142	33
▶ FS15	350	298	389	120	125	230	Rp 3/4"	67	152	33
▶ FS20	350	298	389	120	125	230	Rp 3/4"	67	152	33

* With reduction nipple

** Standard equipment on R40 FS3

BURNER - BOILER MOUNTING FLANGE

FS3 - FS5 - FS8 - FS10

FS15 - FS20

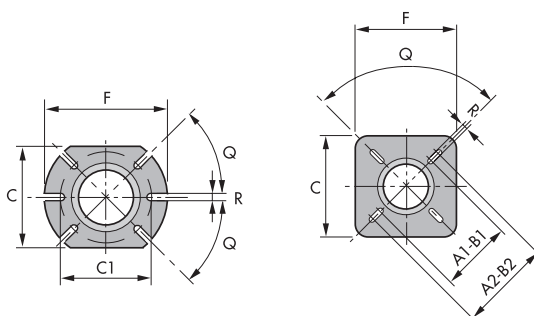

MODEL	A1	A2	B1	B2	C	C1	F	Q	R
▶ FS3	-	-	-	-	140	130	170	45°	10
▶ FS5	-	-	-	-	140	130	170	45°	10
▶ FS8	-	-	-	-	160	130	185	45°	11
▶ FS10	-	-	-	-	160	130	185	45°	11
▶ FS15	155	200	155	200	170	-	170	90°	11
▶ FS20	155	200	155	200	170	-	170	90°	11

PACKAGING

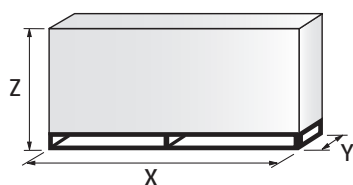

MODEL	X	Y	Z	kg
▶ FS3	375	335	310	9,5
▶ FS5	445	355	335	11
▶ FS8	483	495	330	13
▶ FS10	483	495	330	16
▶ FS15	535	535	375	19
▶ FS20	535	535	375	20

Specification

DESIGNATION OF SERIES

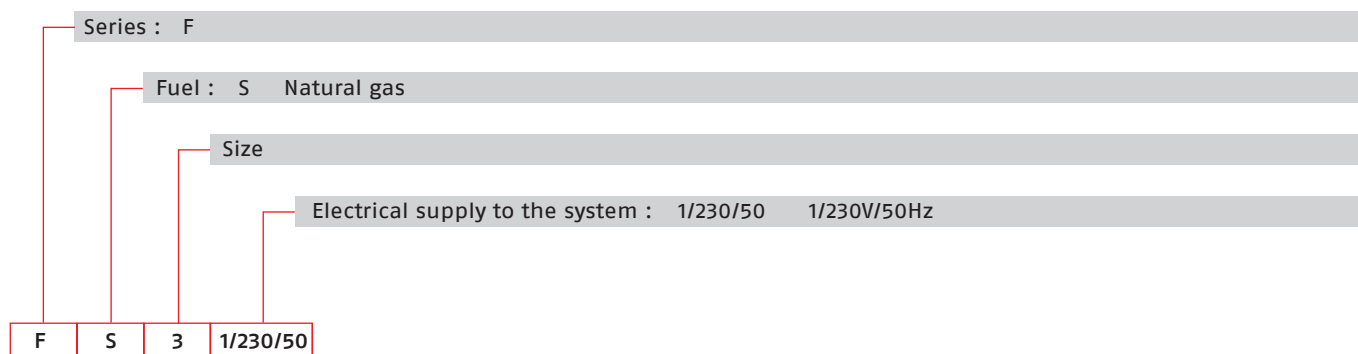

STATE OF SUPPLY

Monoblock, gas burners, completely automatic, with one stage settings fitted with:

- Fan with forward curve blades
- Cover lined with sound-deadening material
- Metallic and fixed air damper with adjustment
- Single phase electric motor 230 V, 50 Hz
- Combustion head fitted with:
 - stainless steel head cone, resistant to high temperatures
 - ignition electrodes
 - ionisation probe
 - gas distributor
 - flame stability disk
 - flame inspection window
- Adjustable air pressure switch, with graduated selector, to guarantee burner lock out in the case of insufficient combustible air
- Microprocessor-based flame control box, with diagnostic functions
- IP X0D (IP 40) electric protection level.

Standard equipment:

- Flange insulation screen
- Screws and nuts for fixing the flange to the boiler
- 7-pole socket
- Hinge
- Reduction nipple Rp 1/2" - Rp 3/8" (for R40 FS3 only)
- Grommet
- Instruction handbook for installation, use and maintenance
- Spare parts catalogue.

One Stage Gas Burners

RIELLO 40 FS SERIES

Available models

Burners

CODE	MODEL	HEAT OUTPUT		TOTAL ELECTRICAL POWER (kW)	CERTIFICATION	NOTE
		NATURAL GAS				
		(kW)	(Nm ³ /h)			
3756506	FS3	1/230/50	11 - 35	1,1 - 3,5	0,150	CE - 0694 CN7805
3756606	FS5	1/230/50	23 - 58	2,3 - 5,8	0,150	CE - 0694 CN7805 (1)
3756706	FS8	1/230/50	46 - 93	4,6 - 9,3	0,150	CE - 0694 CN7805 (1)
3756435	FS10	1/230/50	42 - 116	4,2 - 11,6	0,130	CE - 0694 CN7805 (1) (2)
3756803	FS15	1/230/50	81 - 175	8,1 - 17,5	0,130	CE - 0694 CN7805 (1) (2)
3756935	FS20	1/230/50	81 - 220	8,1 - 22	0,250	CE - 0694 CN7805 (1) (2)

Models for LPG applications

CODE	MODEL	HEAT OUTPUT		TOTAL ELECTRICAL POWER (kW)	CERTIFICATION	NOTE
		LPG				
		(kW)	(Nm ³ /h)			
3756439	FSP10	1/230/50	42 - 116	1,6 - 4,4	0,130	CE - 0063AP6680 (1) (2)
3756939	FSP20	1/230/50	81 - 220	3,1 - 8,5	0,250	CE - 0063AP6680 (1) (2)

Net calorific value G20: 10 kWh/Nm³ - Density: 0,71 kg/Nm³
 Net calorific value G31 (LPG): 25,8 kWh/Nm³ - Density: 2,02 kg/Nm³
 The burners of FS series are in accordance with EN 676
 (1) With plug and socket
 (2) French version

Gas Trains

GAS TRAIN CODE *	GAS TRAIN MODEL	NATURAL GAS		LPG		NOTE
		BURNER (type)	ADAPTER (code)	BURNER (type)	ADAPTER (code)	
MULTIBLOC GAS TRAIN	3970569	MBC 65/1 - RSD 20	FS3 - FS5		FS3 - FS5	(1)
	3970530	MB 405/1 - RSD 20	FS5 - FS8 - FS20		FS5 - FS8 - FS20	(1) (2)
	3970500	MB 405/1 - RT 20	FS10		FS10	(1) (3)
	3970531	MB 407/1 - RSD 20	FS5 - FS8 - FS10 FS15 - FS20		FS5 - FS8 - FS10 FS15 - FS20	(1) (4)
	3970532	MB 410/1 - RSD 20	FS10 - FS20		FS10 - FS20	(1)

Please see Designation of Gas Train Series in the page before the Catalogue index.

* Gas train are 230V/50Hz - 220V/60Hz electrical supply

(1) With installed plug (if the plug is not necessary, remove it in accordance with gas train instruction manual indication)

(2) FS8 ≤ 80 kW with natural gas

(3) FS10 ≤ 80 kW with natural gas

(4) FS20 ≤ 180 kW with natural gas

The valve seal control device is compulsory (conforming to EN 676) on gas trains to burners with a maximum output over 1200 kW.

To select the gas train please refer to the technical data leaflet and/or instruction manual.

Burner accessories

Remote reset control kit for MG 557/3/5 control box

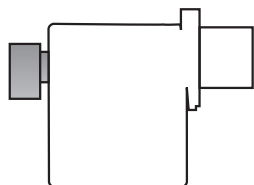

The MG 557 control box can be remotely released using an electric command kit. This kit must be installed in conformity with the local authority.

BURNER	KIT CODE
▶ FS3 – FS5 – FS8 – FS15	3002750

Extended head kit

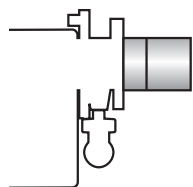

Burners “standard head” can be transformed into “extended head” versions by using the special kit. Here the KITS available for the various burners are listed, showing the original and the extended lengths.

BURNER	STANDARD HEAD LENGTH (mm)	EXTENDED HEAD LENGTH (mm)	KIT CODE
▶ FS3 – FS5	100	125	3000820
▶ FS8 – FS10	110	170	3001064
▶ FS8	110	278	3000920
▶ FS15 – FS20	120	280	3000873

End cone with turbulator disk



The end cone turbulator disk reduces the flame length. It is suitable for oven application (CO emissions) and short boiler chamber.

BURNER	PROJECTION (mm)	KIT CODE
▶ FS5	+15	3000916
▶ FS8	+18	3000917
▶ FS10	+18	3000918
▶ FS20	+23	3000919

LPG kit



For burning LPG gas, a special kit is available to be fitted to the combustion head on the burner as shown in the following table.

BURNER	KIT CODE FOR STANDARD HEAD	KIT CODE FOR EXTENDED HEAD
▶ FS3	3000881	3000881
▶ FS5	3000882	3000882
▶ FS8	3000927	3000927
▶ FS10	3000884	3000884
▶ FS15	3000885	3000885
▶ FS20	3000886	3000886

One Stage Gas Burners

RIELLO 40 FS SERIES

Burner accessories

Inlet air aspiration kit

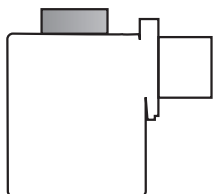

This kit allows to channel the external air directly into the burner and is available as accessory for models:

BURNER	KIT CODE
▶ FS3	20027571
▶ FS5	20027576
▶ FS8 - FS10	20027578
▶ FS15 - FS20	20027581

Town gas kit

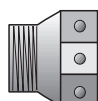

BURNER	KIT CODE
▶ FS3	3000888
▶ FS5	3000889
▶ FS8	3000890
▶ FS10	3000891
▶ FS20	3000893

Ground fault interrupter kit



A "Ground fault interrupter kit" is available as a safety device in case of electrical system fault. It is supplied with burners with pin plug.

BURNER	KIT CODE
▶ FS5 - FS8 - FS10 - FS20	3001180

7-pin plug kit

If necessary a 7-pin plug kit is available (in packaging of n. 5 pieces).

BURNER	KIT CODE
▶ All models	3000945

Continuous ventilation kit for RMG control box

If the burner requires continuous ventilation in the stages without flame, a special kit is available as given in the following table.

BURNER	KIT CODE
▶ FS15 - FS10 - FS20	3010094

Burner accessories

PC interface kit



To connect the control box to a personal computer for the transmission of operation, fault signals and detailed service information, an interface adapter with PC software are available.

BURNER	KIT CODE
▶ FS3 - FS5 - FS8	3002731
▶ FS10 - FS15 - FS20	3002719

Gas train accessories

Seal control kit



To test the valve seals on the gas train, (except for the model with Multibloc MBC 65 DLE) a special "seal control kit" is available.

GAS TRAIN	KIT CODE	
	for 50 Hz operation	for 60 Hz operation
▶ MB/1 type	3010123	20050030