

RIELLO 40 GSD SERIES

The Riello 40 GSD series of two stage gas burners, is a complete range of products developed to respond to any request for home heating. The Riello 40 GSD series is available in two different models, with an output ranging from 41 to 220 kW, divided in two different structures.

All the models use the same components designed by Riello for the Riello 40 GSD series. The high quality level guarantees safe working.

In developing these burners, special attention was paid to reducing noise, to the ease of installation and adjustment, to obtaining the smallest size possible to fit into any sort of boiler available on the market.

All the models are approved by the EN 676 European Standard and conform to European Directives for EMC, Low Voltage, Gas Appliance and Boiler Efficiency.

All the Riello 40 GSD burners are tested before leaving the factory.



GS10D	29/41 ÷ 106 kW
GS20D	58/81 ÷ 220 kW

FIRING RATES

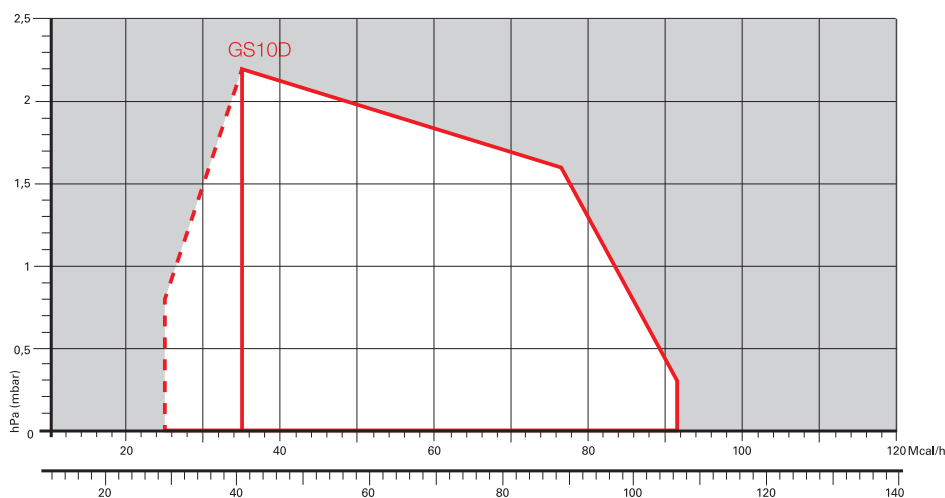

□ Useful working field for choosing the burner

▤ 1st stage operation range

Test conditions conforming to EN676
 Temperature: 20°C
 Pressure: 1013,5 mbar
 Altitude: 0 m a.s.l.

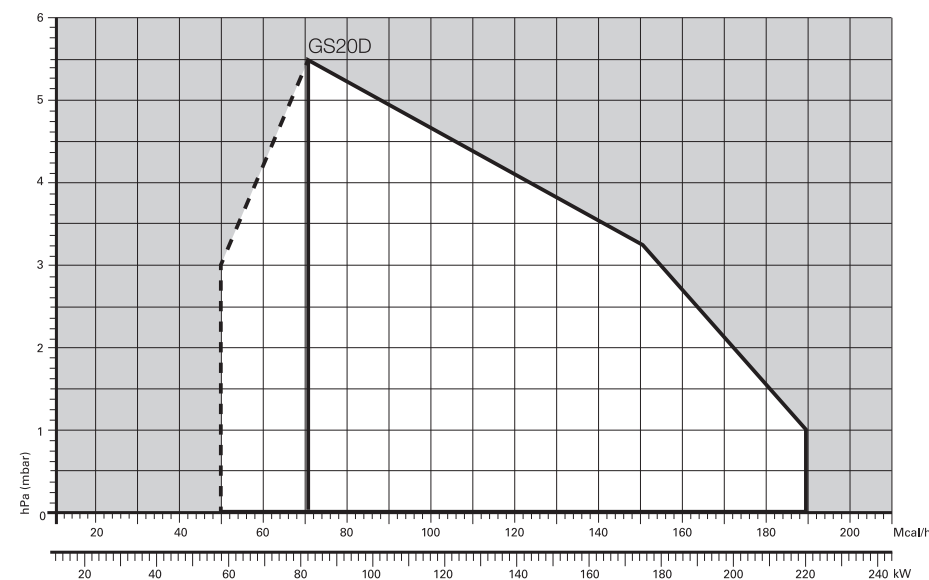

Two Stage Gas Burners

RIELLO 40 GSD SERIES

Overall dimensions (mm)

BURNER

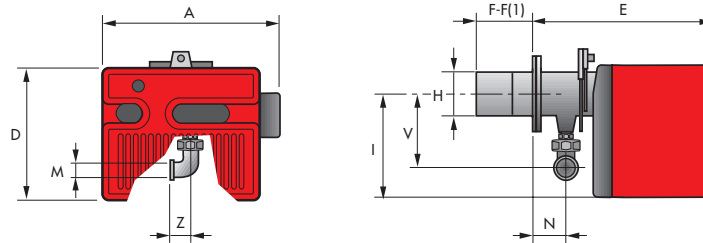

MODEL	A	D	E	F - F(1)	H	I	M	N	V	Z
▶ GS10D	368	262	346	110	105	204	Rp 3/4"	61	142	33
▶ GS20D	413	298	389	120 - 280	125	230	Rp 3/4"	67	152	33

(1) dimension with extended head

BURNER - BOILER MOUNTING FLANGE

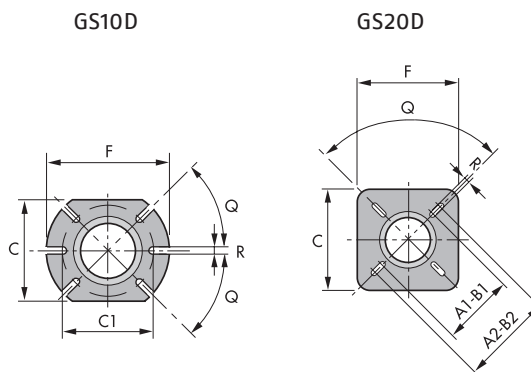

MODEL	A1	A2	B1	B2	C	C1	F	Q	R
▶ GS10D	-	-	-	-	160	130	185	45°	11
▶ GS20D	155	200	155	200	170	-	170	90°	11

PACKAGING

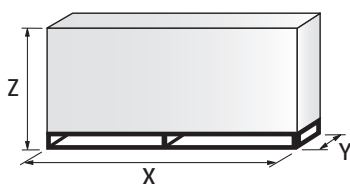

MODEL	X	Y	Z	kg
▶ GS10D	495	483	330	16
▶ GS20D	535	535	375	22

Specification

DESIGNATION OF SERIES

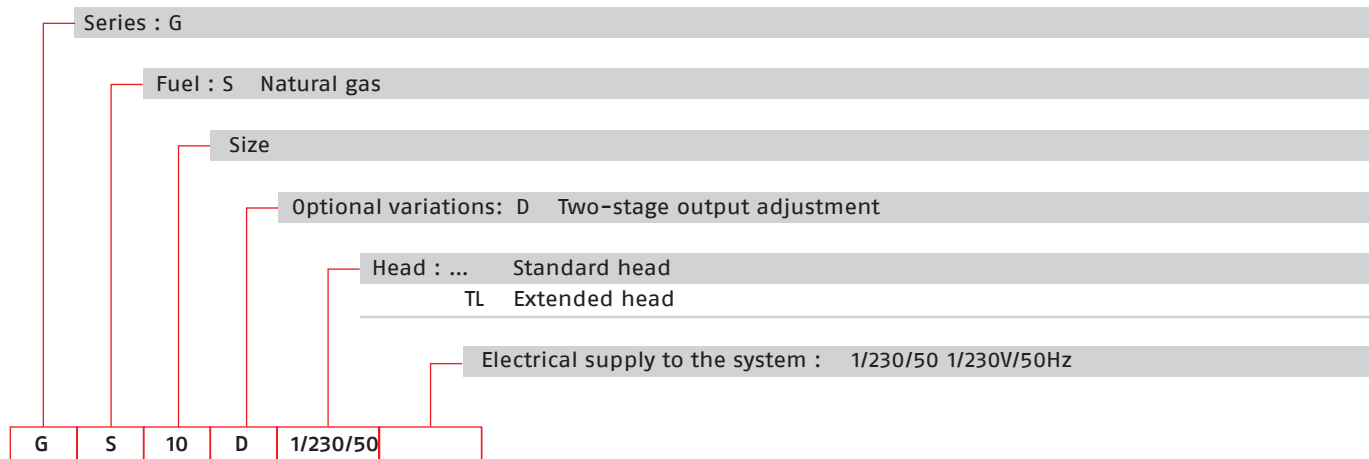

STATE OF SUPPLY

Monoblock, gas burners, completely automatic, two stage operation, made up of:

- Fan with forward curve blades
- Cover lined with sound-proofing material
- Air damper, completely closed in stand by, driven by an electric servomotor
- Air damper with 1st and 2nd stage adjustment
- Single phase electric motor 230 V, 50 Hz
- Combustion head fitted with:
 - stainless steel head cone, resistant to high temperatures
 - ignition electrodes
 - ionisation probe
 - gas distributor
 - flame stability disk
 - flame inspection window
- Adjustable air pressure switch, with graduated selector, to guarantee burner lock out in the case of insufficient combustible air
- Protection filter against radio interference
- IP X0D (IP 40) electric protection level.

Standard equipment:

- Flange insulation screen
- Screws and nuts for fixing the flange to the boiler
- 7-pole socket
- 4-pole socket
- Hinge
- Grommet
- Instruction handbook for installation, use and maintenance
- Spare parts catalogue.

Two Stage Gas Burners

RIELLO 40 GSD SERIES

Available models

Burners

CODE	MODEL	HEAT OUTPUT		TOTAL ELECTRICAL POWER (kW)	CERTIFICATION	NOTE
		(kW)	NATURAL GAS (Nm ³ /h)			
3757615	GS10D 1/230/50	29/41 - 106	2,9/4,1 - 10,6	0,130	CE - 0694 CN7805	(1)
3757714	GS20D 1/230/50	58/81 - 220	5,8/8,1 - 22	0,250	CE - 0694 CN7805	(1)

Net calorific value G20: 10 kWh/Nm³ - Density: 0,71 kg/Nm³
 The burners of GSD series are in according to EN 676
 (1) With plug and socket.

Gas Trains

MULTIBLOC GAS TRAINS	GAS TRAIN CODE *	GAS TRAIN MODEL	NATURAL GAS		LPG		NOTE
			BURNER (type)	ADAPTER (code)	BURNER (type)	ADAPTER (code)	
	3970084	MB 405/2 - RSD 20	GS10D		GS10D		(1) (2)
	3970537	MB 407/2 - RSD 20	GS10D - GS20D		GS10D - GS20D		(1) (3)
	3970534	MB 410/2 - RSD 20	GS20D		GS20D		(1)

Please see Designation of Gas Train Series in the page before the Catalogue index.

* Gas train are 230V/50Hz - 220V/60Hz electrical supply

(1) With installed plug

(2) GS10D ≤ 80 kW with natural gas

(3) GS20D ≤ 180 kW with natural gas

The valve seal control device is compulsory (conforming to EN 676) on gas trains to burners with a maximum output over 1200 kW.

To select the gas train please refer to the technical data leaflet and/or instruction manual.

Burner accessories

Extended head kit

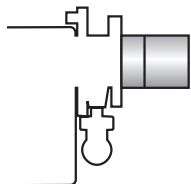

Burners "standard head" can be transformed into "extended head" versions by using the special kit. Here the KITS available for the various burners are listed, showing the original and the extended lengths.

BURNER	STANDARD HEAD LENGTH (mm)	EXTENDED HEAD LENGTH (mm)	KIT CODE
▶ GS10D	100	170	3001064
▶ GS20D	120	280	3000873

End cone with turbulator disk



The end cone turbulator disk reduces the flame length. It is suitable for hoven application (CO emissions) and short boiler chamber.

BURNER	PROJECTION (mm)	KIT CODE
▶ GS10D	+18	3000918
▶ GS20D	+23	3000919

LPG kit

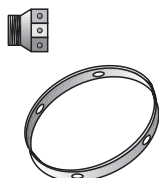

For burning LPG gas, a special kit is available to be fitted to the combustion head on the burner as shown in the following table.

BURNER	KIT CODE FOR STANDARD HEAD	KIT CODE FOR EXTENDED HEAD
▶ GS10D	3000884	3000884
▶ GS20D	3000886	3000886

Town gas kit

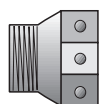

BURNER	KIT CODE
▶ GS10D	3000891
▶ GS20D	3000894

Ground fault interrupter kit



A "Ground fault interrupter kit" is available as a safety device in case of electrical system fault. It is supplied with burners with pin plug.

BURNER	KIT CODE
▶ GS10D - GS20D	3001180

Two Stage Gas Burners

RIELLO 40 GSD SERIES

Burner accessories

7-pin plug kit

If necessary a 7-pin plug kit is available (in packaging of n. 5 pieces).

BURNER	KIT CODE
► GS10D – GS20D	3000945

Continuous ventilation kit for RMG control box

If the burner requires continuous ventilation in the stages without flame, a special kit is available as given in the following table.

BURNER	KIT CODE
► GS10D – GS20D	3010094

PC interface kit



To connect the control box to a personal computer for the transmission of operation, fault signals and detailed service information, an interface adapter with PC software are available.

BURNER	KIT CODE
► GS10D – GS20D	3002719

Gas train accessories

Seal control kit



To test the valve seals on the gas train a special "seal control kit" is available.

GAS TRAIN	KIT CODE for 50 Hz operation	KIT CODE for 60 Hz operation
► MB/1 type	3010123	20050030