

RS/M SERIES

The RS/M burners series covers a firing range from 45 to 2650 kW, and it has been designed for use in low or medium temperature hot water boilers, hot air or steam boilers, diathermic oil boilers.

Operation can be "two stage progressive" or, alternatively, "modulating" with the installation of a PID logic regulator and respective probes.

RS/M burners series guarantees high efficiency levels in all the various applications, thus reducing fuel consumption and running costs.

The exclusive design ensures reduced dimensions, simple use and maintenance. Optimisation of sound emissions is guaranteed by the special design of the air suction circuit and by incorporated sound proofing material.

A wide range of accessories guarantees elevated working flexibility.



RS 34/M MZ	45/125 ÷	390 kW
RS 44/M MZ	80/203 ÷	550 kW
RS 50/M MZ	80/285 ÷	630 kW
RS 64/M MZ	150/400 ÷	850 kW
RS 70/M	150/470 ÷	930 kW
RS 100/M	150/700 ÷	1340 kW
RS 130/M	254/920 ÷	1600 kW
RS 150/M	300/900 ÷	1850 kW
RS 190/M	470/1279 ÷	2290 kW
RS 250/M MZ	600/1250 ÷	2650 kW

FIRING RATES

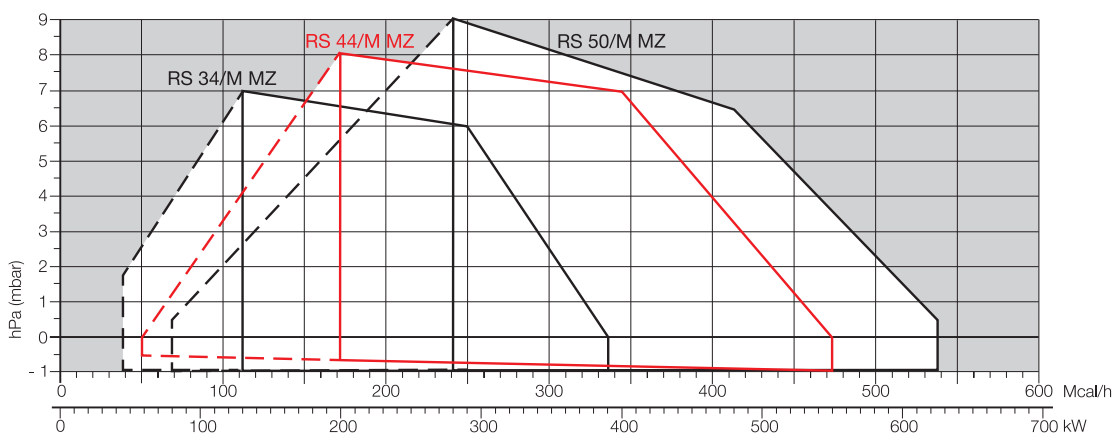

 Useful working field for choosing the burner

 Modulation range

Test conditions conforming to EN676
 Temperature: 20°C
 Pressure: 1013,5 mbar
 Altitude: 0 m a.s.l.

Modulating Gas Burners

RS/M SERIES

FIRING RATES

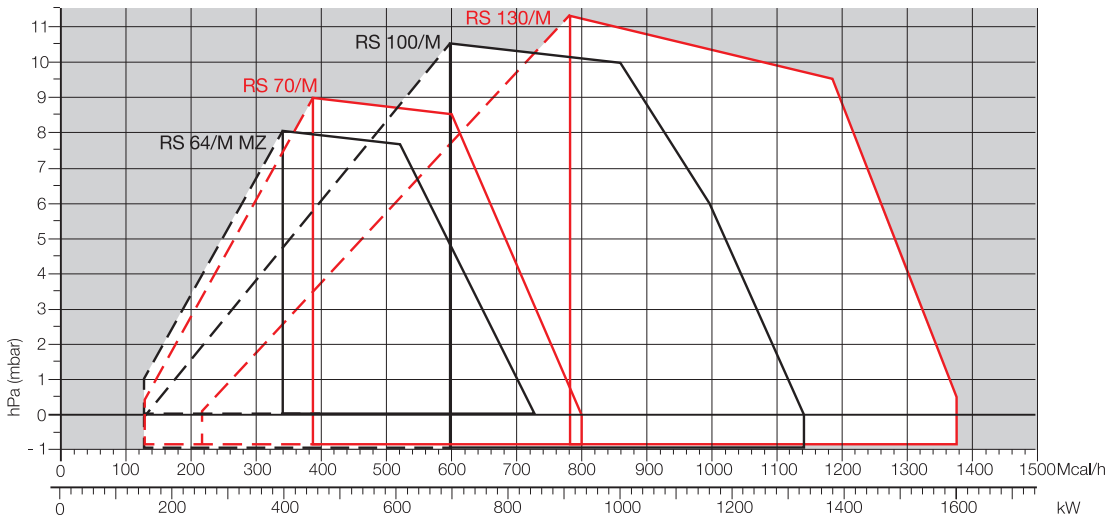

□ Useful working field for choosing the burner

▤ Modulation range

Test conditions conforming to EN676
 Temperature: 20°C
 Pressure: 1013,5 mbar
 Altitude: 0 m a.s.l.

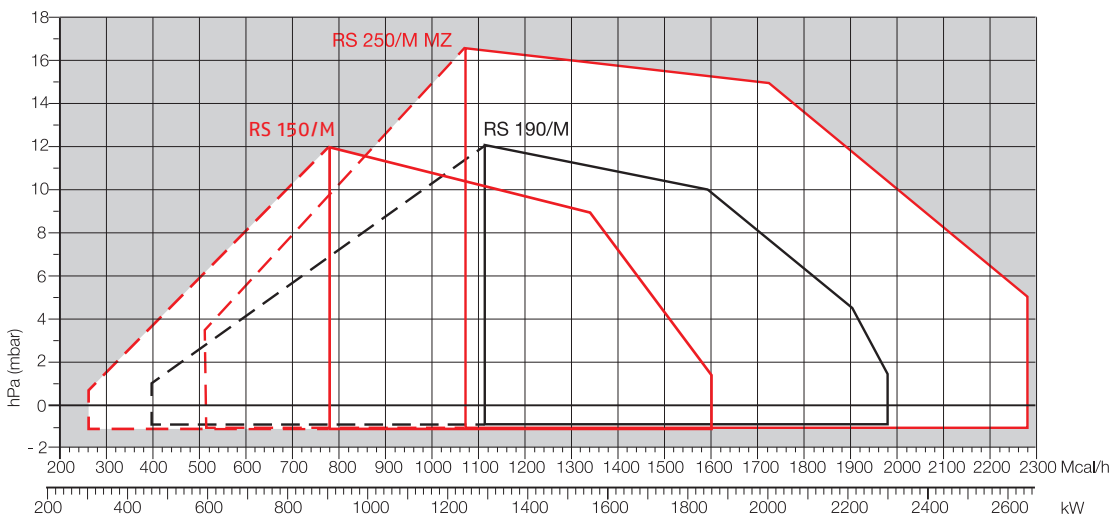

Overall dimensions (mm)

BURNER

RS 34/M MZ - 44/M MZ

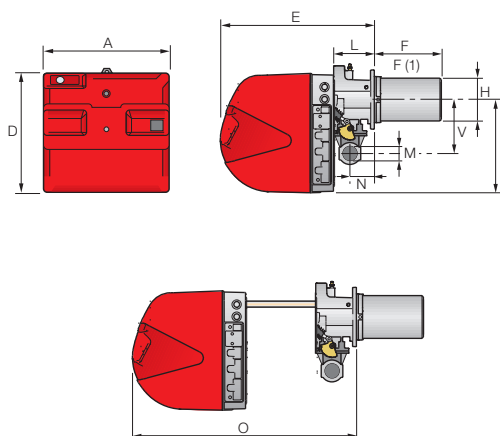

RS 50/M MZ

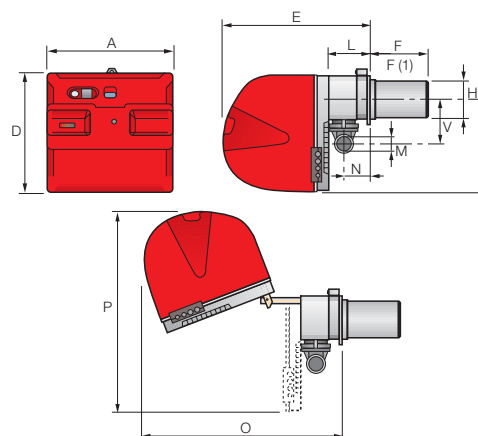

MODEL	A	D	E	F - F(1)	H	I	L	M	N	O	P	V
▶ RS 34/M MZ	442	422	508	216 - 351	140	305	138	1"1/2	84	780	-	177
▶ RS 44/M MZ	442	422	508	216 - 351	152	305	138	1"1/2	84	780	-	177
▶ RS 50/M MZ	476	474	580	216 - 351	152	352	164	1"1/2	108	810	719	168

(1) dimension with extended head

RS 64/M MZ

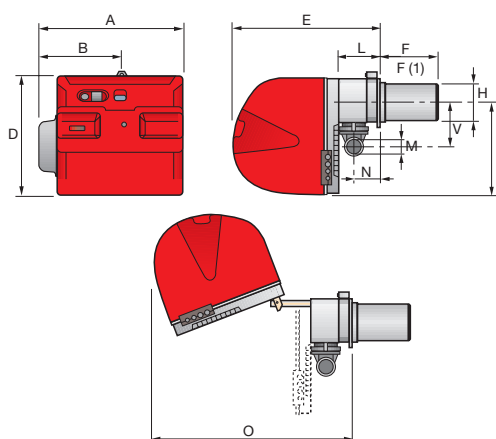

RS 70/M - 100/M - 130/M - 150/M - 190/M - 250/M MZ

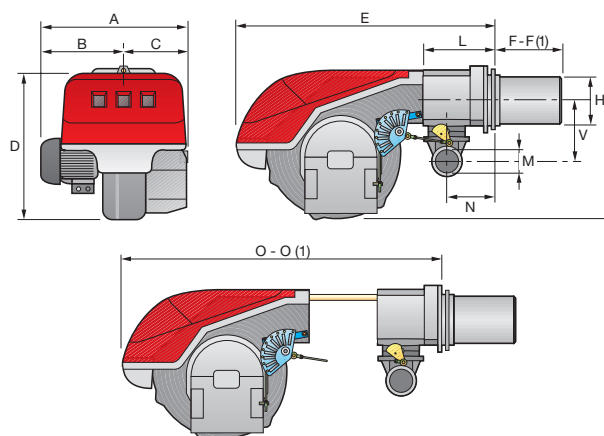

MODEL	A	B	C	D	E	F - F(1)	H	I	L	M	N	O - O(1)	V
▶ RS 64/M MZ	533	300	-	490	640	250 - 385	179	352	222	2"	134	870 - -	221
▶ RS 70/M	511	296	215	555	840	250 - 385	179	430	214	2"	134	1161 - 1296	221
▶ RS 100/M	527	312	215	555	840	250 - 385	179	430	214	2"	134	1161 - 1296	221
▶ RS 130/M	553	338	215	555	840	280 - 415	189	430	214	2"	134	1161 - 1296	221
▶ RS 150/M	675	370	305	590	840	280 - 415	189	435	214	2"	134	1180 - 1315	221
▶ RS 190/M	681	366	315	555	872	370 - 520	222	430	230	2"	150	1328 - -	221
▶ RS 250/M MZ	732	427	305	555	872	370 - 520	222	430	230	2"	150	1328 - -	262

(1) dimension with extended head

Modulating Gas Burners

RS/M SERIES

Overall dimensions (mm)

BURNER - BOILER MOUNTING FLANGE

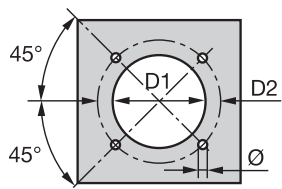

MODEL	D1	D2	Ø
▶ RS 34/M MZ	160	224	M8
▶ RS 44/M MZ	160	224	M8
▶ RS 50/M MZ	160	224	M8
▶ RS 64/M MZ	185	275-325	M12
▶ RS 70/M	185	275-325	M12
▶ RS 100/M	185	275-325	M12
▶ RS 130/M	195	275-325	M12
▶ RS 150/M	195	275-325	M12
▶ RS 190/M	230	325-368	M16
▶ RS 250/M MZ	230	325-368	M16

PACKAGING

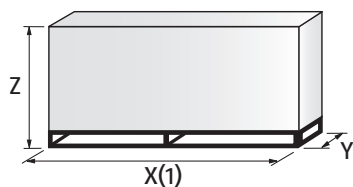

MODEL	X (1)	Y	Z	kg
▶ RS 34/M MZ	1000	485	500	32
▶ RS 44/M MZ	1000	485	500	33
▶ RS 50/M MZ	1200	502	520	41
▶ RS 64/M MZ	1200	580	520	42
▶ RS 70/M	1405	700	660	70
▶ RS 100/M	1405	700	660	73
▶ RS 130/M	1405	700	660	76
▶ RS 150/M	1400-1420	1000	660	110
▶ RS 190/M	1400-1420	1000	660	115
▶ RS 250/M MZ	1400-1420	1040	725	117

(1) dimension with standard and extended head

Specification

DESIGNATION OF SERIES

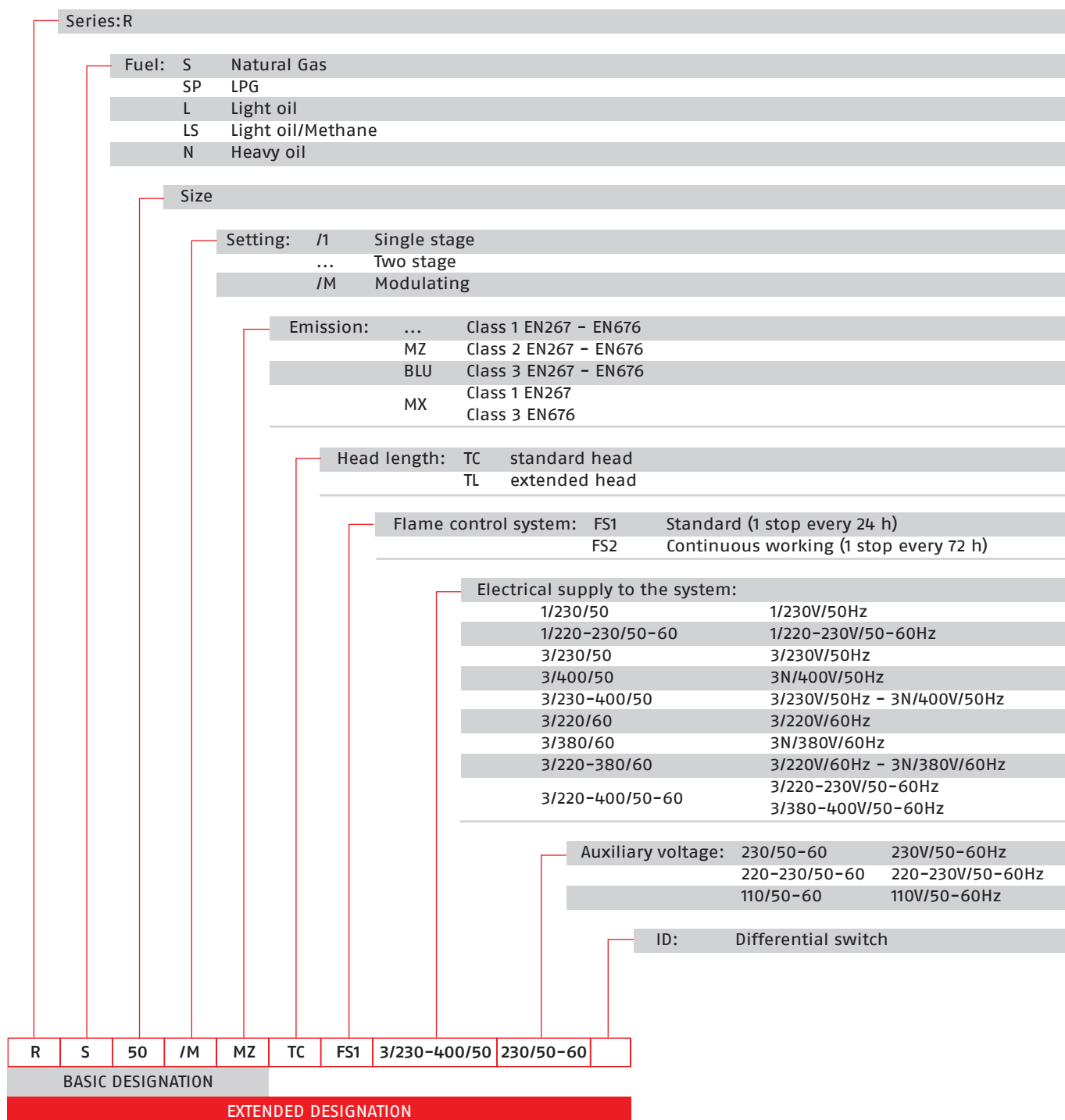

Specification

STATE OF SUPPLY

RS 34/M MZ – 44/M MZ models

Monoblock forced draught gas burner with two stage progressive or modulating operation, with a specific kit, fully automatic, made up of:

- Air suction circuit **with sound proofing material**
- High performance fan with straight blades
- Air damper for air flow setting and butterfly valve for regulating fuel output controlled by a servomotor with variable cam
- Starting motor at 2800 rpm, single-phase / 230V / 50-60Hz or three-phase / 230-400V / 50-60Hz
- Combustion head, that can be set on the basis of required output, fitted with:
 - stainless steel end cone, resistant to corrosion and high temperatures
 - ignition electrodes
 - ionisation probe
 - gas distributor
 - flame stability disk
- Exclusive patented HCS (Housing Cooling System) with high thermal insulation and air circulation with continuous air volume refresh for an active cooling system and avoid heat transfer to the electrical component housing
- Minimum air pressure switch stops the burner in case of insufficient air quantity at the combustion head
- Microprocessor-based burner safety control box, with diagnostic functions
- Plugs and Sockets for electrical connection, accessible from the external of the cover
- Burner on/off selection switch
- Manual or automatic output increase/decrease selection switch
- Flame inspection window
- Slide bars for easier installation and maintenance
- Protection filter against radio interference
- IP 40 electric protection level.

Standard equipment:

- 1 gas train flange
- 1 flange gasket
- 4 screws for fixing the flange
- 1 thermal screen
- 4 screws for fixing the burner flange to the boiler
- 3 plugs for electrical connection (RS 34-44/M MZ single-phase)
- 4 plugs for electrical connection (RS 44/M MZ three-phase)
- Instruction handbook for installation, use and maintenance
- Spare parts catalogue.

RS/M SERIES

Specification

STATE OF SUPPLY

RS 50/M MZ – 64/M MZ – 70/M – 100/M – 130/M – 150/M – 190/M – 250/M MZ models

Monoblock forced draught gas burner with two stage progressive or modulating operation, with a specific kit, fully automatic, made up of:

- Air suction circuit lined with sound-proofing material
- Fan with reverse curve blades (RS 50 – 70 – 100 – 130/M models) or straight blades (RS 64/M MZ – 150/M – 190/M – 250/M MZ models)
- Air damper for air flow setting and butterfly valve for regulating fuel output controlled by a servomotor with variable cam
- Starting motor at 2800 rpm, three-phase 400V with neutral, 50Hz
- Combustion head, that can be set on the basis of required output, fitted with:
 - stainless steel end cone, resistant to corrosion and high temperatures
 - ignition electrodes
 - ionisation probe
 - gas distributor
 - flame stability disk
- Maximum gas pressure switch to stop the burner in the case of excess pressure on the fuel supply line
- Minimum air pressure switch stops the burner in case of insufficient air quantity at the combustion head
- Microprocessor-based burner safety control box, with diagnostic functions
- Burner on/off selection switch
- Manual or automatic output increase/decrease selection switch
- Flame inspection window
- Slide bars for easier installation and maintenance
- Protection filter against radio interference
- IP 44 electric protection level.

Standard equipment:

- 1 gas train flange
- 1 flange gasket
- 4 screws for fixing the flange
- 1 thermal screen
- 4 screws for fixing the burner flange to the boiler
- Wiring loom fittings for the electrical connection (RS 64-50/M MZ)
- 2 slide bar extensions (for extended head models and RS 150-190/M models)
- Instruction handbook for installation, use and maintenance
- Spare parts catalogue.

Modulating Gas Burners

RS/M SERIES

Available models

Burners

CODE	MODEL				HEAT OUTPUT		TOTAL ELECTRICAL POWER (kW)	CERTIFICATION	NOTE
					NATURAL GAS				
					(kW)	(Nm ³ /h)			
3788710	RS 34/M	MZ TC	FS1 1/230/50-60	230/50-60	45/125÷390	4,5/12,5÷39	0,6	CE 0085BR0378	(1)
3788711	RS 34/M	MZ TL	FS1 1/230/50-60	230/50-60	45/125÷390	4,5/12,5÷39	0,6	CE 0085BR0378	(1)
3788810	RS 44/M	MZ TC	FS1 1/230/50-60	230/50-60	80/203÷550	8/20,3÷55	0,7	CE 0085BR0378	(1)
3788811	RS 44/M	MZ TL	FS1 1/230/50-60	230/50-60	80/203÷550	8/20,3÷55	0,7	CE 0085BR0378	(1)
3788840	RS 44/M	MZ TC	FS1 3/230-400/50-60	230/50-60	80/203÷550	8/20,3÷55	0,75	CE 0085BR0378	(1)
3788841	RS 44/M	MZ TL	FS1 3/230-400/50-60	230/50-60	80/203÷550	8/20,3÷55	0,75	CE 0085BR0378	(1)
3781622	RS 50/M	MZ TC	FS1 3/230-400/50	230/50-60	80/285÷630	8/29÷63	0,75	CE 0085AQ0709	(1)
3781623	RS 50/M	MZ TL	FS1 3/230-400/50	230/50-60	80/285÷630	8/29÷63	0,75	CE 0085AQ0709	(1)
3781682	RS 50/M	MZ TC	FS1 3/220-380/60	230/50-60	80/285÷630	8/29÷63	0,66	-	(1)
3781683	RS 50/M	MZ TL	FS1 3/220-380/60	230/50-60	80/285÷630	8/29÷63	0,66	-	(1)
3788910	RS 64/M	MZ TC	FS1 3/230-400/50	230/50-60	150/400÷850	15/40÷85	1,5	CE 0085BR0558	(1)
3788911	RS 64/M	MZ TL	FS1 3/230-400/50	230/50-60	150/400÷850	15/40÷85	1,5	CE 0085BR0558	(1)
3788920	RS 64/M	MZ TC	FS2 3/230-400/50	230/50-60	150/400÷850	15/40÷85	1,5	CE 0085BR0558	(1)
3788921	RS 64/M	MZ TL	FS2 3/230-400/50	230/50-60	150/400÷850	15/40÷85	1,5	CE 0085BR0558	(1)
3788980	RS 64/M	MZ TC	FS1 3/220-380/60	230/50-60	150/400÷850	15/40÷85	1,5	-	(1)
3788981	RS 64/M	MZ TL	FS1 3/220-380/60	230/50-60	150/400÷850	15/40÷85	1,5	-	(1)
3789610	RS 70/M	TC	FS1 3/230-400/50	230/50-60	150/470÷930	15/47÷93	1,4	CE 0085AQ0708	(2)
3787040	RS 70/M	TC	FS1 3/230-400/50	230/50-60 ID	150/470÷930	15/47÷93	1,4	CE 0085AQ0708	(2)
3789611	RS 70/M	TL	FS1 3/230-400/50	230/50-60	150/470÷930	15/47÷93	1,4	CE 0085AQ0708	(2)
3787041	RS 70/M	TL	FS1 3/230-400/50	230/50-60 ID	150/470÷930	15/47÷93	1,4	CE 0085AQ0708	(2)
3866203	RS 70/M	TC	FS1 3/230-400/50	230/50-60	150/470÷930	15/47÷93	1,4	CE 0085AQ0708	(1)
on demand	RS 70/M	TL	FS1 3/230-400/50	230/50-60	150/470÷930	15/47÷93	1,4	CE 0085AQ0708	(1)
3787082	RS 70/M	TC	FS1 3/220-380/60	230/50-60	150/470÷930	15/47÷93	1,4	-	(2)
3787083	RS 70/M	TL	FS1 3/220-380/60	230/50-60	150/470÷930	15/47÷93	1,4	-	(2)
3789710	RS 100/M	TC	FS1 3/230-400/50	230/50-60	150/700÷1340	15/70÷134	1,8	CE 0085AQ0708	(2)
3787240	RS 100/M	TC	FS1 3/230-400/50	230/50-60 ID	150/700÷1340	15/70÷134	1,8	CE 0085AQ0708	(2)
3789711	RS 100/M	TL	FS1 3/230-400/50	230/50-60	150/700÷1340	15/70÷134	1,8	CE 0085AQ0708	(2)
3787241	RS 100/M	TL	FS1 3/230-400/50	230/50-60 ID	150/700÷1340	15/70÷134	1,8	CE 0085AQ0708	(2)
3866204	RS 100/M	TC	FS1 3/230-400/50	230/50-60	150/700÷1340	15/70÷134	1,8	CE 0085AQ0708	(1)
on demand	RS 100/M	TL	FS1 3/230-400/50	230/50-60	150/700÷1340	15/70÷134	1,8	CE 0085AQ0708	(1)
3787282	RS 100/M	TC	FS1 3/380/60	230/50-60	150/700÷1340	15/70÷134	2,1	-	(2)
3787283	RS 100/M	TL	FS1 3/220-380/60	230/50-60	150/700÷1340	15/70÷134	2,1	-	(2)

Natural Gas, net calorific value: 10 kWh/Nm³ - Density at 20°C: 0,71 kg/Nm³

The burners of RS/M series are in according to 2009/142 - 2004/108 - 2006/95 - 2006/42 EC Directive and EN 676 Norm.

(1) With plug and socket.

(2) With terminal board.

RS/M SERIES

Available models

Burners

CODE	MODEL				HEAT OUTPUT		TOTAL ELECTRICAL POWER (kW)	CERTIFICATION	NOTE
					NATURAL GAS				
					(kW)	(Nm ³ /h)			
3789810	RS 130/M	TC	FS1 3/230-400/50	230/50-60	240/920÷1600	24/92÷160	2,6	CE 0085AQ0708	(2)
3787440	RS 130/M	TC	FS1 3/230-400/50	230/50-60 ID	240/920÷1600	24/92÷160	2,6	CE 0085AQ0708	(2)
3789811	RS 130/M	TL	FS1 3/230-400/50	230/50-60	240/920÷1600	24/92÷160	2,6	CE 0085AQ0708	(2)
3787441	RS 130/M	TL	FS1 3/230-400/50	230/50-60 ID	240/920÷1600	24/92÷160	2,6	CE 0085AQ0708	(2)
3866205	RS 130/M	TC	FS1 3/230-400/50	230/50-60	240/920÷1600	24/92÷160	2,6	CE 0085AQ0708	(1)
on demand	RS 130/M	TL	FS1 3/230-400/50	230/50-60	240/920÷1600	24/92÷160	2,6	CE 0085AQ0708	(1)
3787482	RS 130/M	TC	FS1 3/220-380/60	230/50-60	240/920÷1600	24/92÷160	2,6	-	(2)
3787483	RS 130/M	TL	FS1 3/220-380/60	230/50-60	240/920÷1600	24/92÷160	2,6	-	(2)
20044638	RS 150/M	TC	FS1 3/400/50	230/50-60	300/900÷1850	30/90÷185	3,5	in progress	(2)
20044639	RS 150/M	TL	FS1 3/400/50	230/50-60	300/900÷1850	30/90÷185	3,5	in progress	(2)
20051315	RS 150/M	TC	FS1 3/230/50	230/50-60	300/900÷1850	30/90÷185	3,5	in progress	(2)
20051316	RS 150/M	TL	FS1 3/230/50	230/50-60	300/900÷1850	30/90÷185	3,5	in progress	(2)
3787623	RS 190/M	TC	FS1 3/400/50	230/50-60	470/1279-2290	47/128-229	5,5	CE 0085AT0042	(2)
3787622	RS 190/M	TC	FS1 3/230/50	230/50-60	470/1279-2290	47/128-229	5,5	CE 0085AT0042	(2)
3787640	RS 190/M	TC	FS1 3/400/50	230/50-60 ID	470/1279-2290	47/128-229	5,5	CE 0085AT0042	(2)
20011675	RS 190/M	TC	FS1 3/230/50	230/50-60 ID	470/1279-2290	47/128-229	5,5	CE 0085AT0042	(2)
3866206	RS 190/M	TC	FS1 3/400/50	230/50-60	470/1279-2290	47/128-229	5,5	CE 0085AT0042	(1)
20052616	RS 190/M	TL	FS1 3/400/50	230/50-60	470/1279-2290	47/128-229	5,5	CE 0085AT0042	(1)
20011708	RS 190/M	TC	FS1 3/230/50	230/50-60	470/1279-2290	47/128-229	5,5	CE 0085AT0042	(1)
3787682	RS 190/M	TC	FS1 3/220-380/60	230/50-60	470/1279-2290	47/128-229	5,5	-	(2)
3787681	RS 190/M	TC	FS1 3/220/60	220/60	470/1279-2290	47/128-229	5,5	-	(2)
3788410	RS 250/M MZ	TC	FS1 3/400/50	230/50-60	600/1250÷2650	60/125÷265	6,5	CE 0085BS0114	(2)
3788411	RS 250/M MZ	TL	FS1 3/400/50	230/50-60	600/1250÷2650	60/125÷265	6,5	CE 0085BS0114	(2)
3788440	RS 250/M MZ	TC	FS1 3/230/50	230/50-60	600/1250÷2650	60/125÷265	6,5	CE 0085BS0114	(2)
3788441	RS 250/M MZ	TL	FS1 3/230/50	230/50-60	600/1250÷2650	60/125÷265	6,5	CE 0085BS0114	(2)
3788420	RS 250/M MZ	TC	FS2 3/400/50	230/50-60	600/1250÷2650	60/125÷265	6,5	CE 0085BS0114	(2)
3788421	RS 250/M MZ	TL	FS2 3/400/50	230/50-60	600/1250÷2650	60/125÷265	6,5	CE 0085BS0114	(2)
3788450	RS 250/M MZ	TC	FS2 3/230/50	230/50-60	600/1250÷2650	60/125÷265	6,5	CE 0085BS0114	(2)
3788451	RS 250/M MZ	TL	FS2 3/230/50	230/50-60	600/1250÷2650	60/125÷265	6,5	CE 0085BS0114	(2)
20008162	RS 250/M MZ	TC	FS1 3/220-380/60	220/60	600/1250÷2650	60/125÷265	6,5	-	(2)

Natural Gas, net calorific value: 10 kWh/Nm³ - Density at 20°C: 0,71 kg/Nm³

The burners of RS/M series are in according to 2009/142 - 2004/108 - 2006/95 - 2006/42 EC Directive and EN 676 Norm.

(1) With plug and socket.

(2) With terminal board.

Modulating Gas Burners

RS/M SERIES

Available models

Gas Trains

CODE	GAS TRAIN			VPS CODE	ADAPTER CODE									
	MODEL	Ø	C.T.		RS 34	RS 44-50	RS 64	RS 70	RS 100	RS 130	RS 150	RS 190	RS 250	
3970500*	MB 405/1 - RT 20	Rp 3/4"	-	3010123	3000824	●	●	●	●	●	●	●	●	
3970553*	MB 407/1 - RT 20	Rp 3/4"	-	3010123		●	●	●	●	●	●	●	●	
3970599*	MB 407/1 - RT 52	Rp 3/4"	-	3010123		●	●	●	●	●	●	●	●	
3970229*	MB 407/1 - RSM 20	Rp 3/4"	-	3010123		●	●	●	●	●	●	●	●	
3970258*	MB 410/1 - RT 52	Rp 1" 1/4	-	3010123	3010124	3000843		●	●	●	●	●	●	
3970554*	MB 410/1 - RT 20	Rp 3/4"	-	3010123	3000824	3000824 + 3000843	●	●	●	●	●	●	●	
3970600*	MB 410/1 - RT 52	Rp 3/4"	-	3010123			●	●	●	●	●	●	●	●
3970230*	MB 410/1 - RSM 20	Rp 3/4"	-	3010123			●	●	●	●	●	●	●	●
3970256*	MB 412/1 - RT 52	Rp 1" 1/2	-	3010123	-	-								
3970144*	MB 412/1 - RT 20	Rp 1" 1/2	-	3010123	-	-								
3970197**	MB 412/1 CT RT 20	Rp 1" 1/2	◆	-	-	-								
3970231*	MB 412/1 - RSM 20	Rp 1" 1/2	-	3010123	-	-								
3970180*	MB 415/1 - RT 30	Rp 1" 1/2	-	3010123	-	-								
3970198**	MB 415/1 CT RT 30	Rp 1" 1/2	◆	-	-	-								
3970250*	MB 415/1 - RT 52	Rp 1" 1/2	-	3010123	-	-								
3970253**	MB 415/1 CT RT 52	Rp 1" 1/2	◆	-	-	-								
3970232*	MB 415/1 - RSM 30	Rp 1" 1/2	-	3010123	-	-								
3970181*	MB 420/1 - RT 30	Rp 2"	-	3010123	3000822	-	-	-	-	-	-	-	-	
3970182**	MB 420/1 CT RT 30	Rp 2"	◆	-		-	-	-	-	-	-	-	-	-
3970257*	MB 420/1 - RT 52	Rp 2"	-	3010123		-	-	-	-	-	-	-	-	-
3970252**	MB 420/1 CT RT 52	Rp 2"	◆	-		-	-	-	-	-	-	-	-	-
3970233*	MB 420/1 - RSM 30	Rp 2"	-	3010123		-	-	-	-	-	-	-	-	-
3970234**	MB 420/1 CT RSM 30	Rp 2"	◆	-		-	-	-	-	-	-	-	-	-
3970221*	MBC 1200/1 - RSM 60	Rp 2"	-	3010367		-	-	-	-	-	-	-	-	-
3970225**	MBC 1200/1 CT RSM 60	Rp 2"	◆	-	-	-	-	-	-	-	-	-	-	
3970222*	MBC 1900/1 - FSM 40	DN 65	-	3010367	●	●								
3970226**	MBC 1900/1 CT FSM 40	DN 65	◆	-	●	●								
3970223*	MBC 3100/1 - FSM 40	DN 80	-	3010367	●	●								
3970227**	MBC 3100/1 CT FSM 40	DN 80	◆	-	●	●								
3970224	MBC 5000/1 - FSM 80	DN 100	-	3010367	●	●	●	●	●	●	●	●	3010370 +	
3970228	MBC 5000/1 CT FSM 80	DN 100	◆	-	●	●	●	●	●	●	●	●	3000826	

Please see designation of Gas Train Series in the page before the Catalogue index.

* 230V/50Hz -220V/60Hz electrical supply.

** 230V/50Hz electrical supply.

The valve seal control device is compulsory (conforming to EN 676) on gas trains to burners with a maximum output over 1200 kW.

To select the gas train please refer to the technical data leaflet and/or instruction manual.

C.T. Gas valve leak detection control device:

- gas train not equipped with leak detection control device; this device can be ordered separately - see VPS column - and installed later.

◆ gas train equipped with leak detection control device.

VPS Valve leak detection control device. Supplied separately from the gas train (please see Gas train accessories paragraph for both 50 Hz and 60 Hz codes).

● Not available.

RS/M SERIES

Available models

Gas Trains

CODE	GAS TRAIN			VPS CODE	ADAPTER CODE							
	MODEL	Ø	C.T.		RS 34	RS 44-50	RS 64	RS 70	RS 100	RS 130	RS 150	RS 190
3970145*	CB 512/1 - RSM 30	Rp 1" 1/2	-	3010367	-	-	3000843					
20045589**	CB 512/1 CT RSM 30	Rp 1" 1/2	◆	-	-	-	3000843					
3970146*	CB 520/1 - RSM 30	Rp 2"	-	3010367	3000822	-	-	-	-	-	-	-
3970160**	CB 520/1 CT RSM 30	Rp 2"	◆	-		-	-	-	-	-	-	-
20044659*	CB 525/1 - RSM 30	Rp 2"	-	3010367		-	-	-	-	-	-	-
20044660**	CB 525/1 CT RSM 30	Rp 2"	◆	-		-	-	-	-	-	-	-
3970147*	CB 5065/1 - FSM 30	DN 65	-	3010367	●	3000825						
3970161**	CB 5065/1 CT FSM 30	DN 65	◆	-	●	3000825						
3970148*	CB 5080/1 - FSM 30	DN 80	-	3010367	●	●	3000826					
3970162**	CB 5080/1 CT FSM 30	DN 80	◆	-	●	●	3000826					
3970149*	CB 50100/1 - FSM 30	DN 100	-	3010367	●	●	3010370 + 3000826					
3970163**	CB 50100/1 CT FSM 30	DN 100	◆	-	●	●	3010370 + 3000826					
20015871*	CB 50125/1 - FSM 30	DN 125	-	3010367	●	●	●	●	●	3010224 + 3000826		
3970196**	CB 50125/1 CT FSM 30	DN 125	◆	-	●	●	●	●	●	3010224 + 3000826		

Please see designation of Gas Train Series in the page before the Catalogue index.

* 230V/50Hz -220V/60Hz electrical supply.

** 230V/50Hz electrical supply.

The valve seal control device is compulsory (conforming to EN 676) on gas trains to burners with a maximum output over 1200 kW.

To select the gas train please refer to the technical data leaflet and/or instruction manual.

C.T. Gas valve leak detection control device:

- gas train not equipped with leak detection control device; this device can be ordered separately - see VPS column - and installed later.

◆ gas train equipped with leak detection control device.

VPS Valve leak detection control device. Supplied separately from the gas train (please see Gas train accessories paragraph for both 50 Hz and 60 Hz codes).

● Not available.

Modulating Gas Burners

RS/M SERIES

Burner accessories

Extended heads

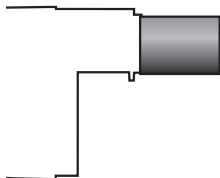

“Standard head” burners can be transformed into “extended head” versions, by using the special kit. The KITS available for the various burners, giving the original and the extended lengths, are listed below.

BURNER	'STANDARD HEAD' LENGTH (mm)	'EXTENDED HEAD' LENGTH (mm)	KIT CODE
▶ RS 34/M MZ	216	351	3010428
▶ RS 44/M MZ	216	351	3010429
▶ RS 50/M MZ	216	351	3010078
▶ RS 64/M MZ	250	385	3010427
▶ RS 70/M	250	385	3010117
▶ RS 100/M	250	385	3010118
▶ RS 130/M	280	415	3010119
▶ RS 150/M	280	415	20052186
▶ RS 190/M	370	520	3010443 *
▶ RS 250/M MZ	370	520	3010412

* Kit to be used on burners recognizable by a serial number that is over or equal to 02426XXXXXX, for burners with a serial number that is under or equal to 02416XXXXXX please use the Kit coded 3010196

Spacer kit

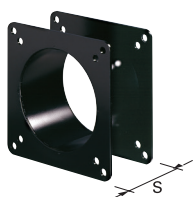

If burner head penetration into the combustion chamber needs reducing, varying thickness spacers are available, as given in the following table:

BURNER	SPACER THICKNESS S (mm)	KIT CODE
▶ RS 34/M MZ - 44/M MZ - RS 50/M MZ	110	3010095
▶ RS 64/M MZ - RS 70/M - 100/M - 130/M - 150/M	135	3010129
▶ RS 190/M - 250/M MZ	102	3000722

Continuous ventilation kit



If the burner requires continuous ventilation in the stages without flame, a special kit is available as given in the following table:

BURNER	KIT CODE
▶ RS 34/M MZ - 44/M MZ	3010449
▶ RS 50/M MZ - 64/M MZ - 70/M - 100/M - 130/M - 150/M - 190/M - 250/M	3010094

Burner accessories

Sound proofing box

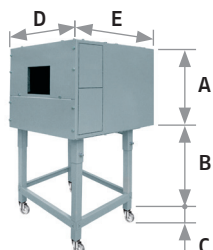

If noise emission needs reducing even further, sound-proofing boxes are available. In case of generator heights, where a lower dimension "B" is required, ask for the Box Support Kit code 20065135. The useful dimensions are 40 mm less than the total dimensions indicated in the table (A, D, E). Not suitable for outdoor use.

BURNER	BOX TYPE	A (mm)	B (mm) min-max	C (mm)	D (mm)	E (mm)	[dB(A)] (*)	BOX CODE
▶ RS 34/M MZ - 44/M MZ - RS 50/M MZ - RS 64/M MZ	C1/3	650	372 - 980	110	690	770	10	3010403
▶ RS 70/M - 100/M - 130/M	C4/5	850	160 - 980	110	980	930	10	3010404
▶ RS 150/M - 190/M								
▶ RS 250/M MZ								

(*) Average noise reduction according to EN 15036-1 standard

Accessories for modulating operation



To obtain modulating operation, the RS/M series of burners requires a regulator with three point outlet controls. The relative temperature or pressure probes fitted to the regulator must be chosen on the basis of the application. The following table lists the accessories for modulating operation with their application range.

BURNER	TYPE	CODE
▶ RS 34/M MZ - 44/M MZ	RWF 40	3010417
▶ RS 50/M MZ	RWF 40	3010212
▶ RS 64/M MZ	RWF 40	20076928
▶ RS 70/M - 100/M - 130/M - 150/M - 190/M - 250/M MZ	RWF 40	3010414

PROBE



BURNER	PROBE TYPE	RANGE (°C) (bar)	CODE
▶ All models	Temperature PT 100	-100 ÷ 500°C	3010110
	Pressure 4 ÷ 20 mA	0 ÷ 2,5 bar	3010213
	Pressure 4 ÷ 20 mA	0 ÷ 16 bar	3010214
	Pressure 4 ÷ 20 mA	0 ÷ 25 bar	3090873

ANALOG CONTROL SIGNAL CONVERTER



Modulating operation can also be obtained with an analog control signal converter and a feedback three-pole potentiometer. Alternatively, the potentiometer can be used to check the servomotor position.

BURNER	TYPE (INPUT SIGNAL)	CODE
▶ RS 34/M MZ - 44/M MZ	0/2 - 10 V (impedance 200 K Ω) 0/4 - 20 mA (impedance 250 Ω)	3010410
▶ RS 50/M MZ - RS 64/M MZ	0/2 - 10 V (impedance 200 K Ω) 0/4 - 20 mA (impedance 250 Ω)	on demand
▶ RS 70/M - 100/M - 130/M 150/M - RS 190/M - 250/M MZ	0/2 - 10 V (impedance 200 K Ω) 0/4 - 20 mA (impedance 250 Ω)	3010415

Modulating Gas Burners

RS/M SERIES

Burner accessories

Potentiometer kit



BURNER	KIT CODE
▶ RS 34/M MZ – 44/M MZ	3010420
▶ RS 50/M MZ – RS 64/M MZ	3010109
▶ RS 70/M – 100/M – 130/M – 150/M – 190/M – 250/M MZ	3010416

Connection flange kit

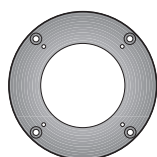

A kit is available for use where the burner opening on the boiler is of excessive diameter.

BURNER	KIT CODE
▶ RS 34/M MZ – 44/M MZ – RS 50/M MZ	3010138

LPG kit



For burning LPG gas, a special kit is available to be fitted to the combustion head on the burner, as given in the following table:

BURNER	KIT CODE FOR 'STANDARD HEAD'	KIT CODE FOR 'EXTENDED HEAD'
▶ RS 34/M MZ	3010423	3010423
▶ RS 44/M MZ	3010424	3010424
▶ RS 50/M MZ	20008173	20008173
▶ RS 64/M MZ	3010434	3010435
▶ RS 70/M	20008175	20008176
▶ RS 100/M	20008177	20008178
▶ RS 130/M	20008179	20008180
▶ RS 150/M	20050064	20050065
▶ RS 190/M	3010166	3010166
▶ RS 250/M MZ	3010411	3010411

Town gas kit



For burning Town gas, a special kit is available:

BURNER	KIT CODE FOR 'STANDARD HEAD' (*)	KIT CODE FOR 'EXTENDED HEAD' (*)
▶ RS 34/M MZ	3010502	3010502
▶ RS 44/M MZ	3010503	3010503
▶ RS 50/M MZ	3010285	3010285
▶ RS 70/M	3010286	3010286
▶ RS 100/M	3010287	3010287
▶ RS 130/M	3010288	3010288
▶ RS 190/M	3010297	3010297
▶ RS 250/M MZ	3010472	3010472

(*) Without CE certification

Burner accessories

Vibration reduction kit



The kit allow you to improve flame stability in some applications, where the boiler/flue assembly is liable to resonate.

BURNER	KIT CODE
▶ RS 50/M MZ TC – RS 50/M MZ TL	3010200
▶ RS 70/M TC – RS 70/M TL	3010201
▶ RS 100/M TC – RS 100/M TL	3010202
▶ RS 130/M TC	3010373
▶ RS 130/M TL	3010374
▶ RS 190/M TC	3010375

Ground fault interrupter kit



A "Ground fault interrupter kit" is available as a safety device for electrical system fault.

BURNER	KIT CODE
▶ RS 34/M MZ – 44/M MZ	3010448
▶ RS 50/M MZ – RS 64/M MZ	3010321
▶ RS 70/M – 100/M – 130/M – 150/M – 190/M – RS 250/M MZ	3010329

Gas max pressure switch kit

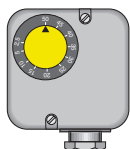

If necessary a Gas max pressure Switch kit is available and connectable to the burner electrical wiring through Plugs & Sockets system.

BURNER (*)	KIT CODE
▶ RS 34/M MZ – 44/M MZ	3010418

(*) Gas max pressure switch is installed as a standard on RS 50/M MZ – 64/M MZ – 70/M – 100/M – 130/M – 190/M – 250/M MZ

Volt free contact kit



A volt free contact kit is available for installation onto the burner. It can be used for a remote interface between burner operating signals. Every burner can be equipped with a single kit for a remote check of the flame presence signal or the burner lockout indication.

BURNER	KIT CODE
▶ RS 34/M MZ – 44/M MZ – 50/M MZ – 64/M MZ	3010419

Modulating Gas Burners

RS/M SERIES

Burner accessories

PC interface kit



To connect the control box to a personal computer for the transmission of operation, fault signals and detailed service information, an interface adapter with PC software are available.

BURNER	KIT CODE
► All models	3002719

DN80 gas flange kit

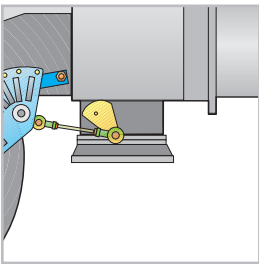

To modify the standard 2" burner gas input connection in to DN80 connection, a specific gas flange is available.

BURNER	KIT CODE
► All models	3010439

Post-ventilation kit

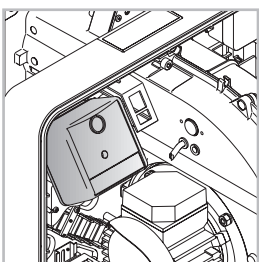

To have 20 s ventilation after opening of thermostats chain, a special kit is available.

BURNER	KIT CODE
► RS 34/M MZ - 44/M MZ	3010451

Hours counter kit

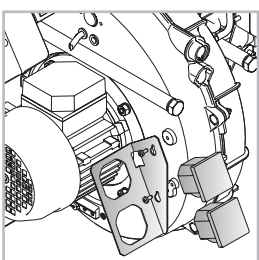

To measure the burner working time a hours counter kit is available.

BURNER	KIT CODE
► RS 34/M MZ - 44/M MZ	3010450

Burner accessories

Protection kit (electromagnetic interferences)

When the burner is installed in a room particularly subject to electromagnetic interference (signals emitted over 10 V/m) due for example to INVERTER presence or in systems where the lengths of the thermostat connections is over 20 meters, this specific protection kit is available as an interface between the thermostatic controls and the burner.

BURNER	KIT CODE
► All models	3010386

Head kit for “reverse flame chamber”



In certain cases, the use of the burner on reverse flame boilers can be improved by using an additional cylinder.









BURNER	STANDARD HEAD LENGTH WITH CYLINDER (mm)	EXTENDED HEAD LENGTH WITH CYLINDER (mm)	KIT CODE (*)
► RS 190/M	493	-	3010241

(*) EC certification in progress

Gas train accessories

Adapters

In certain cases, an adapter must be fitted between the gas train and the burner, when the diameter of the gas train is different from the set diameter of the burner. Below are given the available adapters; please see on the Gas Train list the correct adapter codes to select.

ADAPTER	LENGTH mm	ADAPTER CODE
2"  1" 1/2	70	3000822
3/4"  1" 1/2	31	3000824
DN 65  2" 1/2  2"	300	3000825
DN 80  2" 1/2  1" 1/2	300	3000826
1" 1/2  2"	35	3000843
1" 1/4  1" 1/2	35	3010124
1" 1/4  2"	35	3010126

Gas train accessories

Stabiliser spring



Accessory springs are available to vary the pressure range of the gas train stabilisers. The following table shows these accessories with their application range. Please refer to the technical manual for the correct choice of spring.

GAS TRAIN	SPRING COLOUR	SPRING PRESSURE RANGE mbar	SPRING CODE
▶ MBC 1900/1 - 3100/1 MBC 5000/1	White	4 - 20	3010381
	Red	20 - 40	3010382
	Black	40 - 80	3010383
	Green	80 - 150	3010384
▶ CB 512/1	Red	25 - 55	3010131
	Black	60 - 110	3010157
	Pink	90 - 150	3090486
▶ CB 520/1 - 525/1	Red	25 - 55	3010132
	Black	60 - 110	3010158
	Pink	100 - 150	3090487
▶ CB 5065/1 - 5080/1	Red	25 - 55	3010133
	Black	60 - 110	3010135
	Pink	100 - 150	3090456
	Grey	140 - 200	3090992

Seal control kit



To test the valve seals on the gas train, a special "seal control kit" is available. The valve seal control device is compulsory (EN 676) on gas trains to burners with a maximum output over 1200 kW. The seal control is type VPS 504.

GAS TRAIN	KIT CODE for 50 Hz operation	KIT CODE for 60 Hz operation
▶ MB/1 type	3010123	20050030
▶ MBC/1 type	3010367	20029057
▶ CB/1 type	3010367	20029057