

For the operator

Operating instructions



timeSWITCH 160

Dual-channel timer with weekly programme

GB, IE

Content

Content

1	Notes on the operating instructions	4	4	Operation	13
1.1	Observing other applicable documents	4	4.1	Operating concept	13
1.2	Document storage	4	4.1.1	Operation via selector buttons.....	13
1.3	Symbols used	4	4.2	Overview of menu structure	17
1.4	Identification plate.....	4	4.3	Overview of setting and read-out options.....	19
1.5	Applicability of the instructions	5	4.3.1	Overview of operating modes.....	19
1.6	CE label.....	5	4.3.2	Overview of operating levels	21
2	Safety	6	5	Operating and display functions	23
2.1	Safety and warning information	6	5.1	Information.....	23
2.1.1	Classification of warnings	6	5.1.1	Reading information.....	23
2.1.2	Structure of warnings.....	7	5.1.2	Reading the serial number and article number	23
2.2	Intended use.....	7	5.1.3	Setting timer programmes	24
2.3	Basic safety instructions.....	8	5.1.4	Days away from home scheduling.....	27
3	Description of the appliance	9	5.1.5	Language selection	27
3.1	Appliance design	9	5.1.6	Setting the date	28
3.2	Functionality.....	9	5.1.7	Setting the time	28
3.3	Access level for the operator.....	10	5.1.8	Changing over to daylight saving time.....	28
3.3.1	Menu structure design.....	10	5.1.9	Setting the display contrast	28
3.3.2	Basic display.....	10	5.1.10	Restoring factory settings	29
3.3.3	Selection levels.....	12	5.2	Operating modes.....	30
3.3.4	Setting level.....	12	5.2.1	Operating modes for the heating circuit	30
			5.2.2	Operating modes for hot water production	30

5.3	Advanced function.....	31	10	Technical data	38
5.3.1	Party function.....	31			
5.4	Service message	32	11	Glossary	39
6	Energy-saving tips	33	Index	41
7	Service and troubleshooting	35			
7.1	Cleaning the timer	35			
7.2	Detecting and rectifying faults.....	35			
8	Decommissioning	36			
8.1	Replacing the timer	36			
8.2	Recycling and disposal	36			
9	Warranty and customer service	37			
9.1	Vaillant warranty	37			
9.2	Vaillant Service.....	37			

1 Notes on the operating instructions

1 Notes on the operating instructions

These operating instructions are intended for the operator of the heating system. No particular prior knowledge is required.

1.1 Observing other applicable documents

When operating the timeSWITCH dual-channel timer, always take note of all operating instructions that are supplied with the other components of the heating system.

1.2 Document storage

Keep these operating instructions and all other applicable documents safe so that

- they are available whenever required,
- they are kept for the full service life of the appliance,
- they are available to all subsequent operators.

1.3 Symbols used

The symbols used in the text are explained below:



Useful instructions and information

- Required actions

1.4 Identification plate

The identification plate is located inside the timer and is not accessible from the outside.

1.5 Relevance of the instructions

These operating instructions apply to appliances with the following article numbers only:

Type designation	Article number	Country
VTS160	0020124498	GB

1.1 Type overview

The 10-digit article number can be found in the serial number of the appliance. The article number is found in the second line of the serial number. You can view the serial number under "Menu → Information → Serial number" (→ **fig. 4.9**).

1.6 CE label



The CE labelling shows that, based on the type overview, the units comply with the basic requirements of the applicable directives.



2 Safety







2 Safety

2.1 Safety and warning information

- When operating the timeSWITCH timer, take account of the general safety instructions and the warning notes that appear before all of the actions.

2.1.1 Classification of warnings

The warning notes are classified in accordance with the severity of the possible danger using the following danger signs and signal words:

Danger sign	Signal word	Explanation
	Danger!	Immediate danger to life or danger of severe personal injury
	Danger!	Risk of death from electric shock
	Warning!	Risk of minor personal injury
	Caution!	Risk of material or environmental damage



2.1.2 Structure of warnings

Warning signs are identified by an upper and lower separating line, and are laid out according to the following basic principle:



Signal word!

Type and source of danger!

Explanation of the type and source of danger

- Measures for averting the danger
-

2.2 Intended use

The Vaillant timeSWITCH dual-channel timer has been constructed using state-of-the-art technology in accordance with recognised safety regulations. Even so, in the event of inappropriate or non-intended use, damage to the appliance and other property may arise.

The timeSWITCH timer is a dual-channel timer switch which features daily and weekly programmes for time-dependent control of a Vaillant boiler with and without hot water production. If the unit is used with a Vaillant combi-boiler, it can take over the programming of the warm start function (control of hot water release). The timer is built into the

front of Vaillant ecoTEC boilers. Any other or additional use does not comply with the intended use. The manufacturer/supplier is not liable for any resulting damage. The owner alone bears any risk. Any other use, or use beyond that specified, shall be considered as improper use. Any direct commercial or industrial use is also deemed as improper. The manufacturer/supplier is not liable for any resulting damage. In this case, the user alone bears the liability. Intended use includes:

- observance of accompanying operating, installation and maintenance instructions for Vaillant products as well as for other parts and components of the system
- installation and assembly in accordance with the unit and system approval
- compliance with all inspection and servicing conditions listed in the instructions.

Caution!

Improper use of any kind is prohibited



2 Safety



2.3 Basic safety instructions

Only an approved heating engineer is permitted to carry out installation and repair work on the unit. The existing regulations, rules and guidelines must be observed when doing so.

Preventing malfunction

- Only operate the heating installation when it is in a technically perfect condition.
- Ensure that any faults and damage that affect safety are rectified immediately.

Preventing frost damage

If there is a power cut, or if the room temperature is set too low in individual rooms, it can not be ruled out that sections of the heating system might be damaged by frost.

- If you are going to be away during a cold period, make sure the heating system remains in operation and that the rooms are sufficiently heated.
- Always observe the information on frost protection (→ **section 3.2**).

Even if rooms, or the whole dwelling, are not in use for certain periods, the heating must remain in operation!

Caution!

Frost protection and monitoring devices are only active when the unit is supplied with power. The mains switch on the unit must be set to the position "I".

3 Description of the appliance

- 1 Display
- 2 Right selector button
- 3 Control knob (without pushbutton function)
- 4 Left selector button

3.1 Appliance design

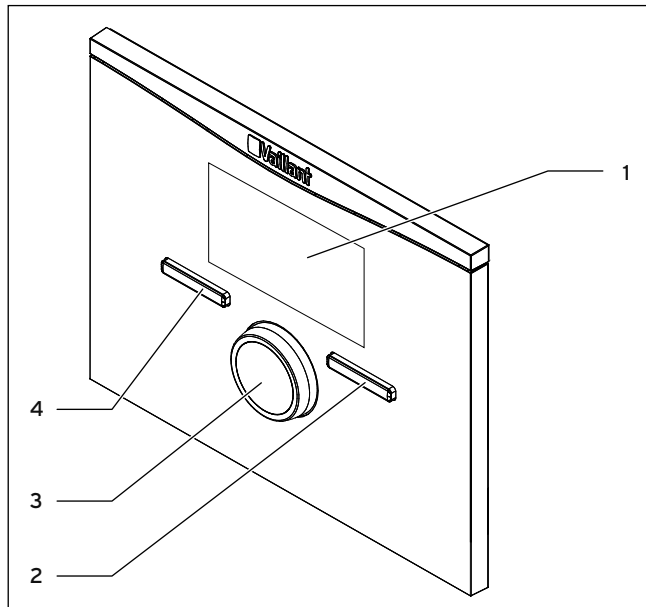

3.1 timeSWITCH front view

3.2 Functionality

The timeSWITCH timer controls the operating times of a Vaillant heating system and the hot water production of a connected domestic hot water cylinder.

Heating installation

You can use the timeSWITCH timer to set the operating times for the heating system for different times of the day and for different days of the week.

Preparation

You can use the timeSWITCH timer to set the time for hot water production. The boiler heats the water in the domestic hot water cylinder. You can set a period during which hot water should be available in the domestic hot water cylinder.

3 Description of the appliance

3.3 Access level for the operator

The access level for the operator provides you with access to important information and offers set-up options which do not require any special prior knowledge. You can access configurable or read-only values via a menu structure.

3.3.1 Menu structure design

The menu structure for the timer is divided into three levels. There are one or two selection levels and one setting level. You can access selection level 1 from the basic display. From each level, you can access the level above or the level below the respective level.

3.3.2 Basic display

The basic display is the permanently visible display on the screen. The basic display shows the current settings and values of the heating system. If you make a setting on the timer, the display on the screen switches from the basic display to the display for new settings.

The basic display appears when you:

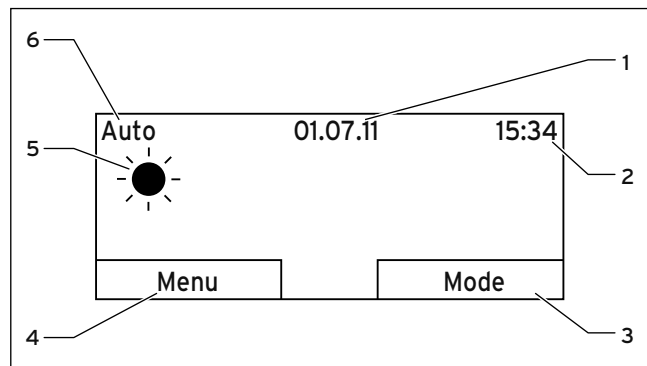

- press the left selector button and thus exit selection level 1.
- do not operate the timer for more than 5 minutes.



3.2 Basic display

- 1 Date
- 2 Time
- 3 Current function of the right selector button (soft key function)
- 4 Current function of the left selector button (soft key function)
- 5 Symbol for heating mode in "Auto" mode
- 6 Mode set for the heating mode

Heating mode symbols

Symbol	Meaning
	Heating operation within a set time period (Comfort mode)
	Heating operation outside a set time period (Set-back mode)

3.1 Heating mode symbols

Soft key function

Both selector buttons have a soft key function.

The current functions of the selector buttons are displayed in the lower display line.

Depending on the selection level selected in the menu structure, the list entry or the value:

- the current function (**4**) of the left selector button may differ.
- the current function (**3**) of the right selector button may differ.

If, for example, you press the left selector button, the current function of the left selector button switches from "Menu" (→ **fig. 3.2**) to "Back" (→ **fig. 3.3**).

Menu

If you press the left selector button "Menu", you will switch from the basic display to selection level 1 of the menu structure.

Mode

If you press the right selector button "Operating mode", you will access the settings under "Operating mode" directly from the basic display. In this way, you can quickly change the operating mode of "HEATING 1" (→ **section 4.3.1**).

3 Description of the appliance

3.3.3 Selection levels

Through the selection levels, you navigate to the setting level in which you wish to read or change settings.

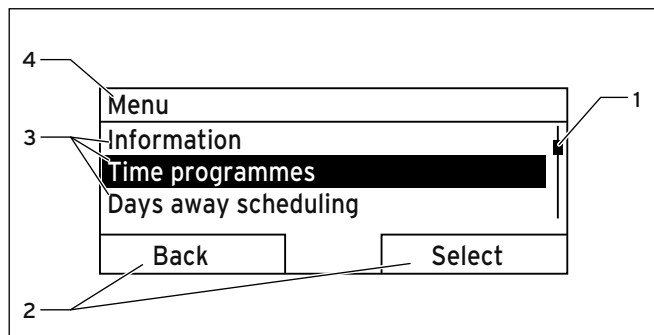

3.3 Display fields in the selection levels

- 1 Scroll bar (only appears if there are more list entries than can be shown at once on the display)
- 2 Current functions of the right and left-hand selector buttons (soft key functions)
- 3 List entries of the selection levels
- 4 Current function or selection level

3.3.4 Setting level

In the setting level, you can select the values you wish to read or change.

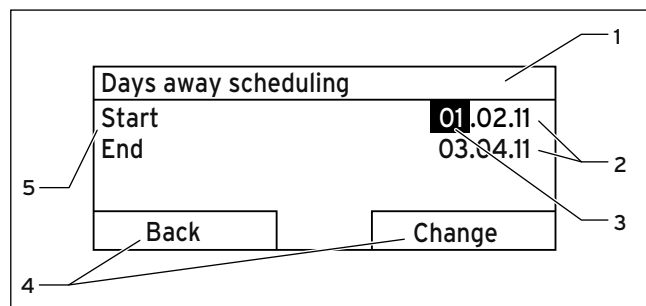

3.4 Display fields in the setting level

- 1 Current selection level
- 2 Values
- 3 Highlighting (white font on black background) shows the current selection.
- 4 Current functions of the right and left-hand selector buttons (soft key functions)
- 5 Setting level

4 Operation

4.1 Operating concept

The timer is operated with two selector buttons and a rotary knob (→ **section. 3.1**)

With the selector buttons you can:

- navigate through the selection levels and the setting level in the menu structure (→ **tab. 4.2**),
- highlight a setting,
- confirm a value,
- activate a mode,
- cancel changing a value.

Use the control knob to:

- navigate through the list entries of a selection level by turning the control knob to the left or right,
- highlight a selection level or a setting level,
- change a selected value.

The display shows a highlighted selection level, a setting level or a highlighted value with white font on a black background. A flashing, highlighted value means that you can change the value.



If you do not operate the timer during a period of more than 5 minutes, the basic display appears in the display again.

4.1.1 Operation via selector buttons

Example: Changing the date

You wish to change the date.

The display shows the basic display.

If the display does not show the basic display, press the left selector button "Back" until the basic display appears.

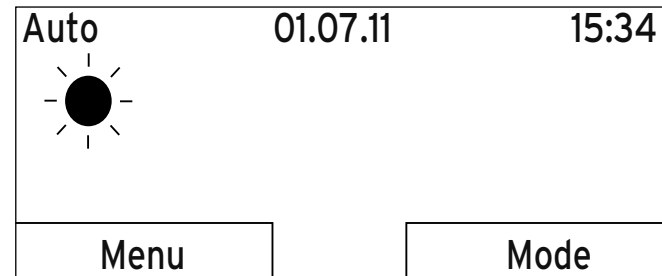

4.1 Basic display

- ▶ Press the left selector button "Menu".

4 Operation

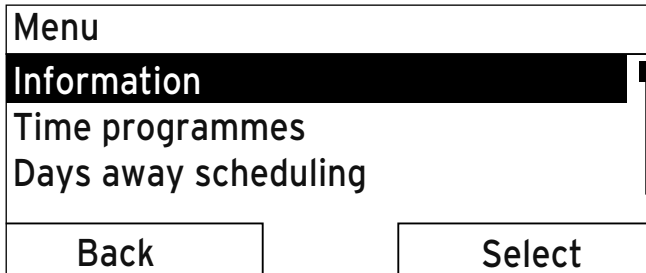

4.2 Selection level 1: "Information"

The timer is now in selection level 1.

The left selector button now has the function "Back" (to the next selection level up), the right selector button has the function "Select" (the next selection level down).

- ▶ Turn the control knob until the "Basic settings" list entry is highlighted.

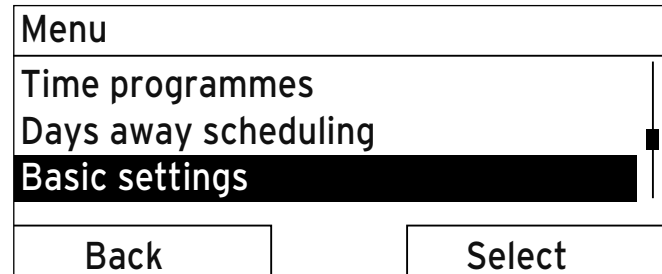

4.3 Selection level 1: "Basic settings"

- ▶ Press the right selector button "Select".

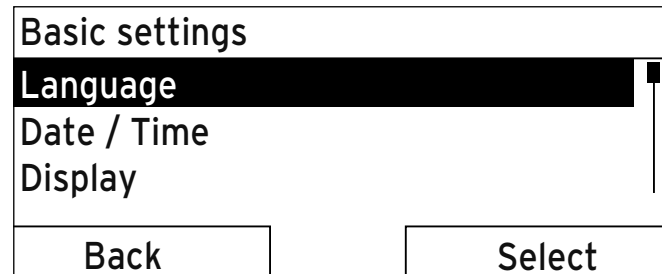

4.4 Selection level 2: "Language"

The timer is now in selection level 2.

- Turn the control knob until the "Date / Time" list entry is highlighted.

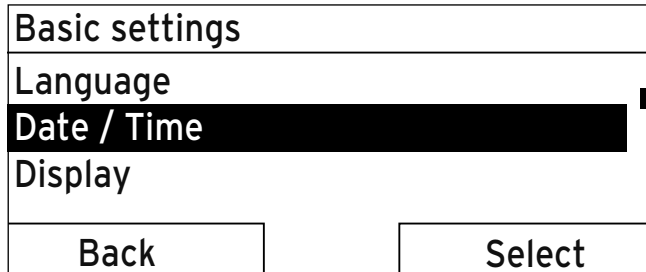

4.5 Selection level 2: "Date / Time"

- Press the right selector button "Select".

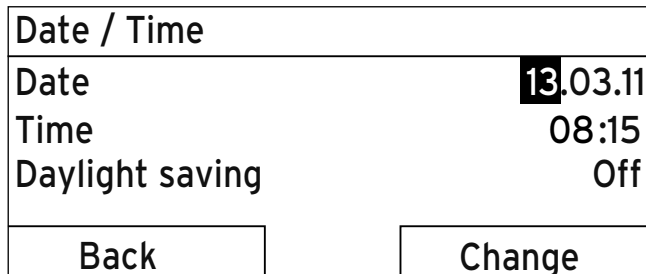

4.6 Setting level: Value for hours highlighted

The timer is now in the "Date" selection level. The day value is highlighted.

The left selector button now has the function "Back" (to the next selection level up), the right selector button has the function "Change" (of the value).

- Press the right selector button "Change".

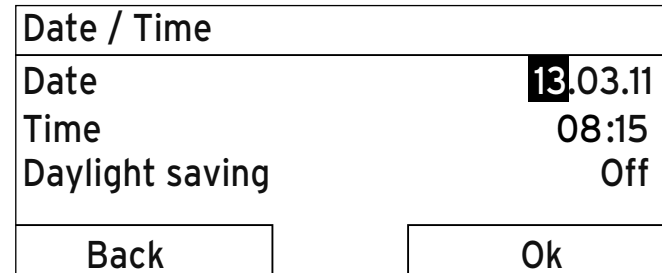

4.7 Setting level: Approving the value to be changed

The highlighted value starts to flash; you can now change the value by turning the rotary knob.

The left selector button now has the function "Cancel" (the change), the right selector button has the function "OK" (to confirm the change).

- Turn the control knob to change the value.
- Press the right selector button, "OK", to confirm the change.

The timer has saved the changed date.

4 Operation

Date / Time	
Date	13.03.11
Time	08:15
Daylight saving	Off
Back	Change

4.8 Setting level: Change saved

- Press the left selector button "Back" repeatedly to switch back to the next selection level up and to access the basic display from selection level 1.

4.2 Overview of menu structure

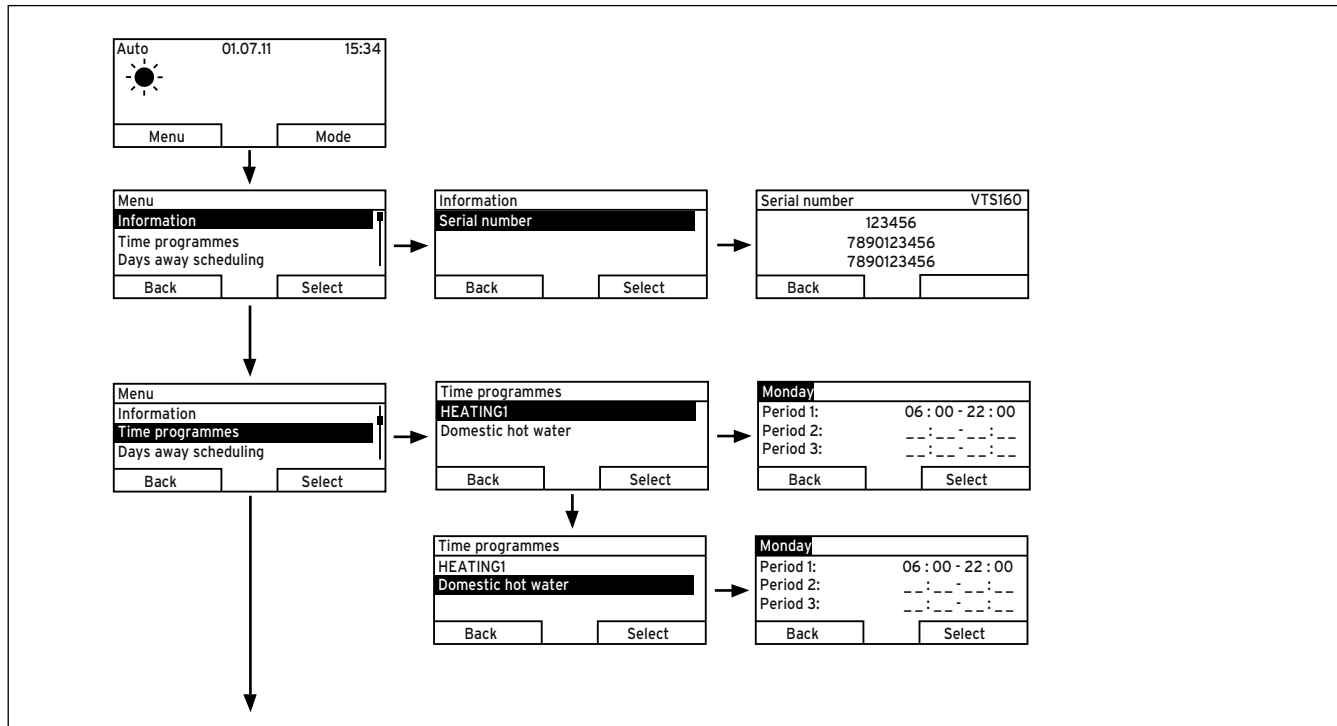

4.9 Overview of menu structure

4 Operation

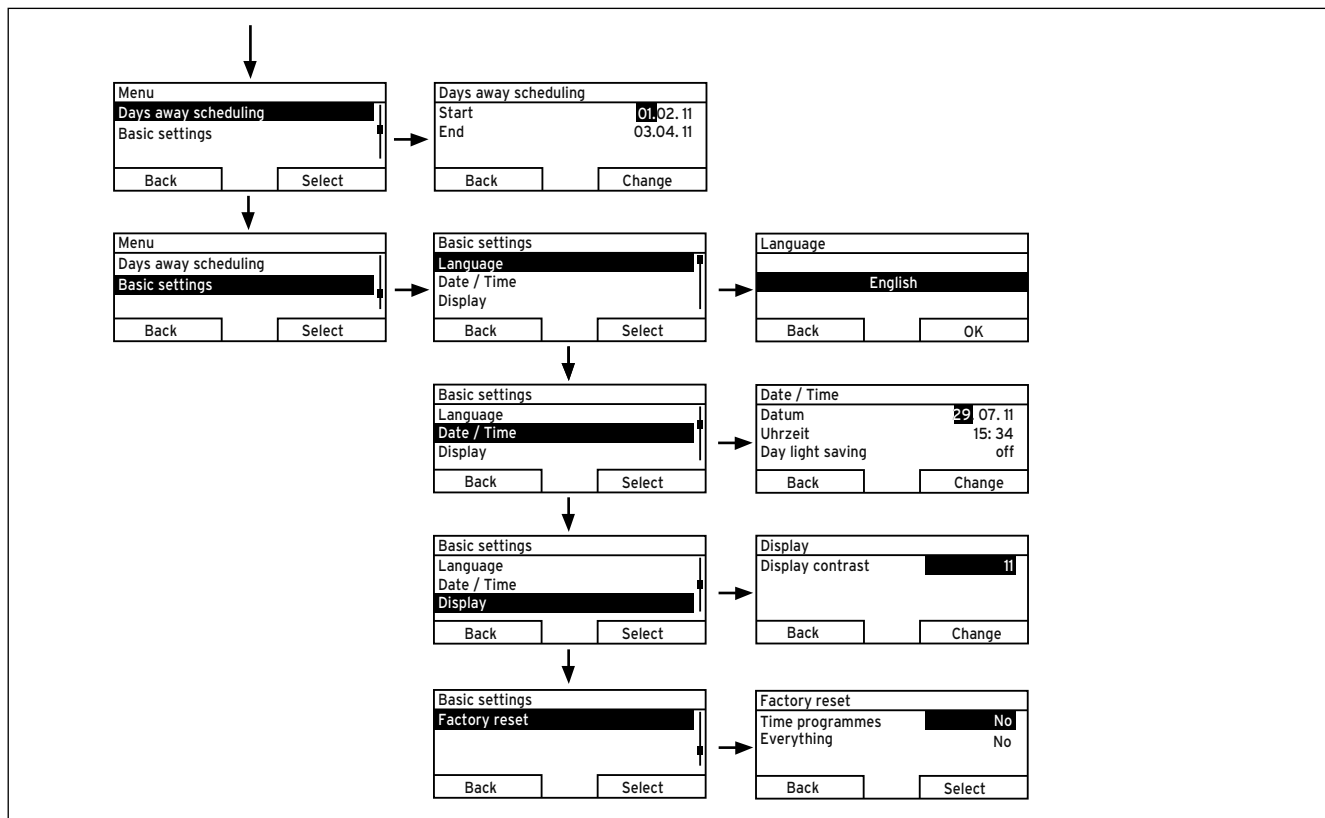

4.9 Overview of menu structure (continued)

4.3 Overview of setting and read-out options

The tables below provide overviews of the timer's operating modes as well as the setting and read-out options.

- If the "Increment/Select" column is blank, these are values that you can read but not adjust.
 - If nothing is entered in a "Selection level 2" column, you will access the setting level directly from selection level 1.
- In the last column, "Own setting", enter that value that has been set by you or the heating engineer.

4.3.1 Overview of operating modes

The right selector button can be used to navigate from the basic display directly to the settings under "Operating mode".

The currently activated mode is stated in the top left of the basic display.

If you have activated an advanced function, the display indicates the advanced function.

4 Operation

Mode	Setting	Factory reset	Own setting
Current mode			
Auto	Automatic mode	Active	
Comfort	Comfort mode	Not active	
System Off	System Off	Not active	
Advanced function			
Party function	Active, Not active	Not active	

4.1 Overview of operating modes

4.3.2 Overview of operating levels

Selection level 1	Selection level 2	Setting level	Values		Unit	Increment/ Select	Factory reset	Own setting
			min.	max.				
Information	Serial number	Number of the appliance	Permanent value					
Time programmes	HEATING 1	Individual days and blocks	-	-	-	Mo, Tu, We, Th, Fr, Sa, Su and Mo - Fr, Sa - Su, Mo - Su	Mo - Fr: 06:00-22:00 Sa: 07:30-23:30 Su: 07:30-22:00	
		Period 1: Start - End Period 2: Start - End Period 3: Start - End	00:00	24:00	h:min	10 min		
	Domestic hot water	Individual days and blocks	-	-	-	Mo, Tu, We, Th, Fr, Sa, Su and Mo - Fr, Sa - Su, Mo - Su	Mo to Fr: 05:30-22:00 Sa: 07:00-23:30 Su: 07:00-22:00	
		Period 1: Start - End Period 2: Start - End Period 3: Start - End	00:00	24:00	h:min	10 min		

4.2 Overview of operating levels

4 Operation

Selection level 1	Selection level 2	Setting level	Values		Unit	Increment/Select	Factory reset	Own setting
			min.	max.				
Days away from home scheduling		Start	01.01.00	31.12.99	dd.mm.yy	Day.Month.Year	01.01.10	
		End	01.01.00	31.12.99	dd.mm.yy	Day.Month.Year	01.01.10	
Basic settings	Language	-	-	-	-	Languages for selection	English	
	Date / Time	Time	00:00	24:00	h:min	10 min	00:00	
		Date	01.01.00	31.12.99	dd.mm.yy	Day.Month.Year	01.01.00	
		Day-light savings			-	Off, Auto	Off	
	Display	Display contrast	01	15	-	1	8	
	Factory reset	Time programmes	-	-	-	Yes, No	No	
		Everything	-	-	-	Yes, No	No	

4.2 Overview of operating levels

5 Operating and display functions

The timer offers various functions, operating modes and an advanced function for controlling the heating circuit and hot water production.

- By using the functions you can read information and set time periods and basic settings.
- By using the operating modes you can select whether the heating circuit and hot water production should be operated in automatic or manual mode.
- By using the advanced function you can change the active operating mode for the heating circuit and hot water production quickly and with time restrictions.

5.1 Information

You can set the functions via the left selector button "Menu".

The path details given at the start of each function description indicate how you reach this function in the menu structure.

5.1.1 Reading information

"Menu" → "Information"

Select the "Information" list entry in selection level 1 to reach selection level 2 with the list entry "Serial number".

5.1.2 Reading the serial number and article number

"Menu" → "Information" → "Serial number"

"Serial number" shows the serial number of the appliance, which the heating engineer may require you to tell him. The article number can be found in the second line of the serial number (→ **fig. 4.9**).

5 Operating and display functions

5.1.3 Setting timer programmes

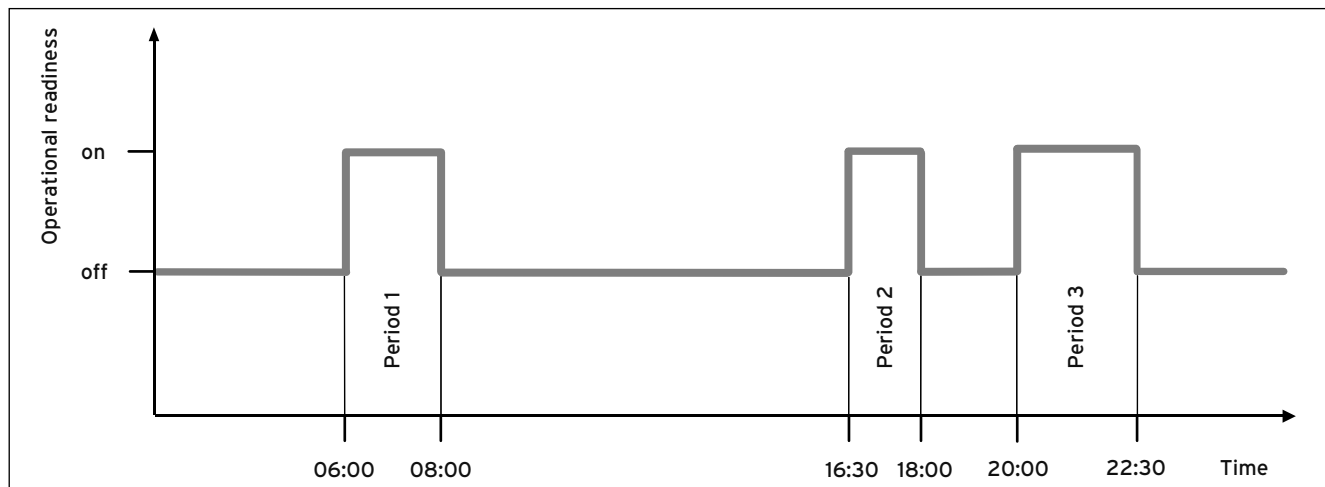

5.1 Example: Three periods in one day

"Menu" → "Time programmes"

Select the "Time programmes" function to set the periods for the heating circuit and for hot water production. If you have not set any periods, the timer uses the periods set in the factory settings (→ **tab. 4.1**).

You can only use the timer's functions and setting options for hot water production if a domestic hot water cylinder is connected to the heating system. The time programmes are only effective for the heating circuit and hot water production in the "Automatic mode".

Periods for the heating circuit

Set the period for the heating circuit so that each period:

- starts approx. 30 minutes before the time at which the rooms should reach the desired temperature.
- ends approx. 30 minutes before the time at which the rooms should reach the desired temperature.

Periods for hot water production

Set the periods for hot water production so that each period:

- starts approx. 30 minutes before the time at which the water in the domestic hot water cylinder should have reached e.g. the temperature set on the boiler.
- ends approx. 30 minutes before the time at which you no longer need any hot water.

Periods for days and blocks

You can set individual days or blocks of days for which the periods should apply:

- Monday, Tuesday, Wednesday, Thursday, Friday, Saturday, Sunday
- Monday - Friday, Saturday - Sunday, Monday - Sunday

For each day and block, you can set up to three periods.



The periods set for a day have priority over the periods set for a block.

Example: Three periods in one day (→ fig. 5.1)

Period 1: 06.00 - 08.00

Period 2: 16.30 - 18.00

Period 3: 20.00 - 22.30

The boiler is ready for operation within the time period.

Examples of individual days:

Monday

Period 1: 06.00 - 07.30

Saturday

Period 1: 07.30 - 10.00

Period 2: 12.00 - 23.30

Examples of blocks:

Monday - Friday

Period 1: 06.30 - 08.00

Period 2: 12.00 - 13.00

Period 3: 17.00 - 22.00

Saturday - Sunday

Period 1: 08.00 - 22.00

Setting time programmes quickly:

If, for example, you need a different period for just one working day in the week, first set the times for the entire block "Monday - Friday". Then set the different period for the working day.

5 Operating and display functions

If you view a block in the display and have defined a different period for a day in this block, then the display indicates the different times in the block with "!!!".

Monday - Sunday	
Period 1:	!! : !! - !! : !!
Period 2:	!! : !! - !! : !!
Period 3:	!! : !! - !! : !!
Back	Select

5.2 Identification of different days

If you press the right selector button "Select", then a message appears on the display which informs you about different periods. You do not need to align the times.

Individual days vary from Mo - Su block.	
Back	Ok

5.3 Exception to the time programme message

The set times for the block marked with "!!!" can be viewed and changed if you press the right selector button "Ok" in the display.

For the heating circuits:

"Menu" → "Time programmes" → "HEATING 1"

The timer switches the heating circuit to comfort mode within the time period and the boiler is ready for operation. The timer switches the heating circuit off outside this time period and the boiler is not ready for operation.

For hot water production:

"Menu" → "Time programmes" → "Domestic hot water"

Hot water production (for a domestic hot water cylinder) or the warm start function (for a combi-boiler) is ready for operation in each set time period.

The hot water is available within this period at the temperature which is set, for example, on the boiler. At the end of a period, the timer switches the hot water production off until the start of the next period.

5.1.4 Days away from home scheduling

"Menu" → "Days away from home scheduling"

By using this function you can set a period with a start and end date for days during which you are away from home. Hot water production is switched off and the frost protection function is activated.

While the "Days away from home scheduling" function is activated it has priority over the set operating mode. At the end of the specified period, or if you cancel the function, the heating system returns to the pre-set mode.

5.1.5 Language selection

"Menu" → "Basic settings" → "Language"



During installation, the heating engineer sets the desired language. All functions are displayed in the set language.

If the language of e.g. a service technician differs from the set language, you can change the language using this function.



Caution!

It may not be possible to operate the timer if the wrong language is selected.

If you select a language that you do not understand, you can no longer read the text in the timer's display and you can no longer operate it.

- Only select a language that you understand.

However, if the text in the display should appear in a language that you do not understand, you can set a different language as follows:

5 Operating and display functions

- Repeatedly press the left selector button until the basic display appears.
- Press the left selector button again.
- Turn the rotary knob to the right until the list entry above the dotted line is highlighted.
- Press the right selector button twice.
- Turn the control knob (to the right or left) until you find a language you understand.
- Press the right selector button.

5.1.6 Setting the date

"Menu" → "Basic settings" → "Date/Time" → "Date"

Select this function to set the current date.

All functions that contain a date relate to the set date.

5.1.7 Setting the time

"Menu" → "Basic settings" → "Date/Time" → "Time"

Select this function to set the current time.

All functions that contain a time relate to the set time.

5.1.8 Changing over to daylight saving time

"Menu" → "Basic settings" → "Date/Time" →

"Day-light savings"

Leave this setting at the factory setting "Off". You will have to change over to daylight saving manually via the time.

- "Off": you will need to switch over to daylight saving time manually.
- "Auto": The timer automatically changes to daylight saving time.



Daylight savings time means Central European summer time: Start = last Sunday in March, End = last Sunday in October.

5.1.9 Setting the display contrast

"Menu" → "Basic settings" → "Display" →

"Display contrast"

You can set the display contrast in relation to the brightness of the surroundings, to ensure that the display is clearly legible.

5.1.10 Restoring factory settings

"Menu" → "Basic settings" → "Factory reset"

You can reset the settings for the "Time Programmes" or for "Everything" to the factory settings.

Time programmes

"Menu" → "Basic settings" → "Factory reset" → "Time programmes"



Before you perform a factory reset for the time programmes, make a note of the timer settings (→ **tab. 4.1**).

With "Time programmes", you will reset all the settings you have made in the "Time programmes" function to the factory settings. All other settings that include times, such as "Date / Time", are not affected.

While the timer is resetting the "Time programmes" settings to the factory settings, "in process" is shown on the display. Then the basic display is displayed.

Everything

"Menu" → "Basic settings" → "Factory reset" → "Everything"

By selecting "Everything" you will reset all of the settings you have made back to the factory settings. This also includes settings such as "Date/Time".

While the timer is resetting all settings to the factory settings, "in process" is shown on the display. Then the basic display is displayed.



Caution!

Risk of a malfunction!

By selecting "Everything" all settings are restored to the factory settings. It may be that it is no longer possible to operate the heating system after this.

- Arrange for the heating engineer to reset all settings to factory settings.

5 Operating and display functions

5.2 Operating modes

You can set the operating modes via the right selector button "Operating mode".

The path details given at the start of each mode description indicate how you reach this mode in the menu structure.

5.2.1 Operating modes for the heating circuit

Automatic mode

"Operating mode" → "(Current operating mode)" → "Automatic operation"

The automatic mode switches the heating circuit to an operational or non-operational state after the set time periods.

You have set time periods for the heating circuit in the "Time programmes" function. If you have not set any periods, the timer, when in automatic mode, uses the periods set in the factory settings (→ **tab. 4.1**).

Within the time period the timer switches the heating mode to the comfort mode.

Outside the time period the timer switches the heating mode to System OFF (frost protection active).

Comfort mode

"Operating mode" → "(Current operating mode)" → "Comfort mode"

The "Comfort mode" function switches the heating circuit to an operational state without regarding any time periods.

System Off

"Operating mode" → "(Current operating mode)" → "System OFF"

The heating function is switched off.

5.2.2 Operating modes for hot water production



The operating mode for hot water production corresponds to the operating mode set for the heating circuit. No other mode can be set.

Automatic mode

The automatic mode controls the hot water production according to the set time periods. In the "Time programmes" function, you have set periods for hot water production. If you have not set any periods, the timer uses the periods set in the factory settings for hot water production (→ **tab. 4.1**).

Within the period, hot water production is ready for operation. Outside the period, hot water production is switched off.

Comfort mode

When in the comfort mode, hot water production is operational without regarding any time periods.

System OFF

Hot water production is switched off.

5.3 Advanced function

The advanced function can be activated directly from any mode by using the right selector button "Operating mode". You can cancel the advanced function at any time by using the left selector button "Cancel".

The path details given at the start of each advanced function description indicate how you reach the advanced function in the menu structure.

5.3.1 Party function

"Operating mode" → "Party"

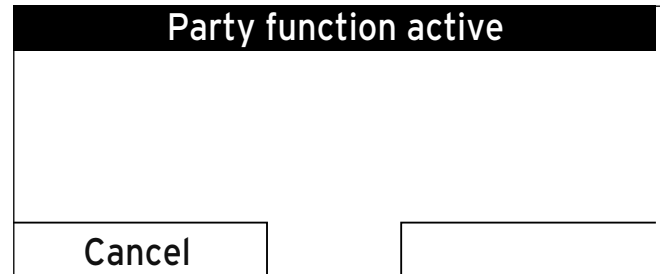

5.4 Party function activated

If you wish to switch on the heating circuit and hot water production temporarily, e.g. during a party, activate the advanced function "Party". This means you do not need to change the settings on the heating system for short periods of time.

The advanced function switches to the comfort mode. The advanced function is deactivated when the next period starts or if you cancel the advanced function first. The heating system will then return to the pre-set mode.

5 Operating and display functions

5.4 Service message

If a fault occurs in the heating system, the timer displays an error message in the display.



Caution!

Risk of damage to the heating system due to failure to perform troubleshooting work!

An error message indicates that the heating engineer must perform troubleshooting or repair work on the heating system. Failure to take notice of these error messages could lead to material damage or breakdown of the heating system.

- If the timer displays an error message, inform a heating engineer.

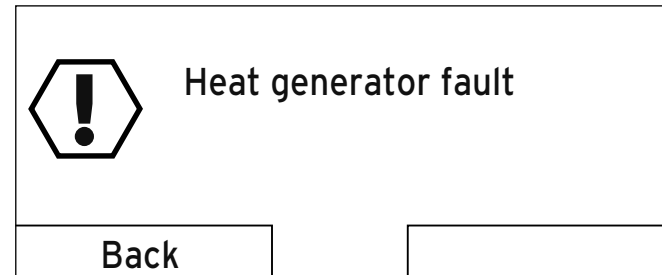

5.5 Example of an error message

If the timer shows an error message in the display instead of the basic display and you press the left selector button "Back", then the basic display appears again.

6 Energy-saving tips

Room temperature during the day

Set the room temperature only as high as would be enough for your comfort level. Each extra degree Celsius would mean an increased energy consumption of about 6%. Adjust the room temperature according to the purpose of use of the room, using the thermostatic radiator valve. For example, it is not necessary to heat bedrooms or seldom used rooms to 20 °C.

Desired temperature during the night

If you do not need a high room temperature, e.g. during the night or if you are away from home, then reduce the room temperature.

Use the "Time programmes" function to define times during which you do not need a high room temperature. The periods for heating are active in "Automatic mode".

If you are absent for longer periods of time, e.g. on holiday, then it is worth lowering the temperature even further. To do this, set the temperature using the "Days away from home scheduling" function.

Uniform heating

Often, in a dwelling with central heating, only one room is heated. Through the surrounding surfaces of this room, i.e. walls, doors, windows, roofs, floors, the unheated adjoining

rooms are also heated in an unregulated manner, i.e. unwanted heat energy is lost. The capacity of the radiator of this one heated room is obviously not enough for such an operating mode. The result is that the room can no longer be heated adequately and there is an uncomfortable feeling of cold. The same effect arises when doors between heated and unheated / barely heated rooms are left open. This is false economy: The heating is in operation and still the room temperature is not comfortably warm. If you heat all rooms evenly and according to their use, then you will achieve a comfortable room climate and energy-saving operation.

Thermostatic radiator valves

Thermostatic radiator valves on the radiators maintain the room temperature exactly once set.

Exception: The thermostatic radiator valves on the radiators in the room in which the room thermostat is mounted, must be turned fully open. The radiators are then controlled by the controller and thus maintain the set room temperature. You can adjust the room temperature to suit your individual requirements and ensure economical operation of your heating system using the thermostatic radiator valves in combination with a room temperature-compensated controller.

6 Energy-saving tips

Economic hot water production

Set the desired temperature of your domestic hot water cylinder only to the temperature you actually need, and under no circumstances higher than 60°C.

You should also use the "Time programmes" function for hot water production in the "Automatic mode". Set the period so that the water is brought to the desired hot water temperature shortly before it is needed, e.g. in the morning after getting up and in the evening after you return home. If you do not need any hot water for a longer period of time, switch hot water production off.

Ventilate correctly

A ventilation boost with fully opened windows and, where possible, with a draught is essential for the room climate and room temperature. The room air will be replaced by outside air in 5 to 10 minutes during a ventilation boost. The air humidity falls and the room is easier to heat up. You will feel warmed even if the room temperature is the same.

7 Service and troubleshooting

7.1 Cleaning the timer

- Clean the casing of the timer with a damp cloth.
- Never use scouring or cleaning agents which could damage the operating elements or the display.

7.2 Detecting and rectifying faults

Fault	Cause	Remedy
Display is dark	Appliance fault	Inform your authorised heating engineer
No changes in the display via the rotary knob		
No changes in the display via the selector buttons		

7.1 Detecting and rectifying faults

8 Decommissioning

8 Decommissioning

8.1 Replacing the timer

If the timer of the heating system needs to be replaced, then the heating system must be shut down.

- This work should be carried out by a heating engineer.

8.2 Recycling and disposal

The timer and the associated transport packaging are predominantly manufactured from recyclable raw materials.



Appliance

If your Vaillant unit is designated with this symbol, it does not belong with your household waste at the end of its useful life.

- In this case, make sure that the Vaillant unit and any accessories are properly disposed of at the end of their useful life.

Packaging

Leave the disposal of the transport packaging to the approved qualified servicing company that installed the appliance.

9 Warranty and customer service

9.1 Vaillant warranty

We only grant a Vaillant manufacturers warranty if a suitably qualified engineer has installed the system in accordance with Vaillant instructions. The system owner will be granted a warranty in accordance with the Vaillant terms and conditions. All requests for work during the guarantee period must be made to Vaillant Service Solutions (0870 6060 777).

9.2 Vaillant Service

To ensure regular servicing, it is strongly recommended that arrangements are made for a Maintenance Agreement. Please contact Vaillant Service Solutions (0870 6060 777) for further details.

10 Technical data

10 Technical data

Description	Unit	VTS 160
Operating voltage U _{max}	V	24
Current consumption	mA	< 50
Protection type	-	IP 20
Protection class	-	III
Max. permissible ambient temperature	°C	50
Height	mm	97
Width	mm	147
Depth	mm	50

10.1 timeSWITCH technical data

11 Glossary

Error message

An error message shows you that the heating system has notified the timer of a fault.

Flow temperature

The boiler heats water which is pumped through the heating installation. The temperature of this hot water as it leaves the boiler is referred to as the flow temperature.

Heating circuit

A heating circuit is a closed circulation system of pipes and heating devices (e. g. radiators). The heated water from the boiler flows into the heating circuit and returns to the boiler as cooled water.

A heating installation usually has at least one heating circuit.

Heating installation

The heating installation heats up the dwelling and produces hot water.

Operating level for the operator

This operating level contains all the functions available to be changed by the operator.

Period

A period is a pre-set, defined period of time during which the boiler, hot water production or the circulation pump is on.

Preparation

The water in the domestic hot water cylinder is heated by the boiler to the set hot water temperature. If the temperature in the domestic hot water cylinder falls by a specific amount, the water is heated up again to the set temperature.

Protection class

Protection class denotes the classification and identification of electrical equipment with reference to the existing safety measures to prevent electric shocks.

Protection type

The level of protection indicates the suitability of electrical equipment for various ambient conditions and additionally the protection of people from potential hazards during their use.

11 Glossary

Room temperature

The room temperature is the temperature actually measured in the dwelling.

Selection level

Via a selection level, you access the next level of the menu structure or settings that you can change.

Status message

A status message appears when you have activated an advanced function. It remains visible for as long as the advanced function is active.

Thermostatic radiator valve

Thermostatic radiator valves are mounted on radiators and control the room temperature to the set value. If the room temperature rises above the pre-set value, the thermostatic radiator valve reduces the heating water flow rate. If the room temperature falls below the pre-set value, the thermostatic radiator valve opens and the heating water flow rate increases and the room temperature rises again.

Timer programme

If you operate the heating system in the "Auto" mode, then activate time periods during which the timer switches the heating system to an operational state. Outside these time periods the timer switches the heating system to "System OFF" and allows the heated room to cool.

You can also use timer programmes to set the hot water production so that hot water is ready and available during the set time periods.

Index

A

Access level for the operator.....	10
Advanced functions	23, 31
Article number	5

B

Basic display	10
---------------------	----

C

Control knob	9
Customer service.....	37

D

Days away from home scheduling.....	27
Disposal.....	36
Domestic hot water cylinder.....	9

E

Energy-saving tips.....	33
-------------------------	----

F

Faults.....	35
Frost protection.....	8, 30
Functions	23

H

Heating circuit automatic mode	30
Heating circuit comfort mode	30
Heating circuit system OFF	30
Hot water production automatic mode.....	30
Hot water production comfort mode.....	31

Index

I		O		
Identification plate	4	Operating modes	23	
Intended use	7	Operating modes for hot water production	30	
L		Operating modes for the heating circuit	30	
Language selection	27	Operation	13	
M		Overview of menu structure	17	
Menu	11	Overview of operating levels	21	
Menu structure	10, 17	Overview of operating modes	19	
P		R		
P		Party function	31	
Menu	11	Periods	24	
Menu structure	10, 17	Preparation	9	
R		Restoring factory settings		29

S

Safety information	6
Selection levels	12
Selector button	11
Serial number	5
Setting level	12
Setting the date	28
Setting the display contrast.....	28
Setting the time	28
Soft key function	11

T

Technical data.....	38
Type overview.....	5

W

Warranty	37
----------------	----

Supplier

Vaillant Ltd

Nottingham Road ■ Belper ■ Derbyshire ■ DE56 1JT

Telephone 0845 602 2922 ■ www.vaillant.co.uk ■ info@vaillant.co.uk

Manufacturer

Vaillant GmbH

Berghauser Str. 40 ■ D-42859 Remscheid ■ Telefon 0 21 91/18-0

Telefax 0 21 91/18-28 10 ■ www.vaillant.de ■ info@vaillant.de

