

For the operator

Operating instructions



ecoTEC

Gas-fired wall-hung high-efficiency boiler

**GB, IE**

# Table of contents

## Table of contents

<b>1</b>	<b>Notes on the documentation</b> .....	3	<b>8</b>	<b>Decommissioning</b> .....	24
1.1	Storing documents .....	3	8.1	Disposing of the boiler .....	24
1.2	Applicability of the instructions .....	3	8.2	Disposing of the packaging .....	24
1.3	Identification plate.....	3			
1.4	CE label.....	3	<b>9</b>	<b>Manufacturer's guarantee and</b>	
1.5	Benchmark.....	3		<b>Vaillant customer services</b> .....	24
			9.1	Factory guarantee.....	24
<b>2</b>	<b>Safety</b> .....	4	9.2	Vaillant Service.....	24
2.1	Safety and warning information .....	4			
2.2	Intended use.....	4	<b>10</b>	<b>Glossary</b> .....	25
2.3	General safety information.....	5			
			<b>Index</b> .....		26
<b>3</b>	<b>Description of devices and functions</b> .....	7		<b>Brief operating instructions</b> .....	27
3.1	Design .....	7			
3.2	Function.....	7			
3.3	Hot water production with domestic hot water cylinder .....	7			
<b>4</b>	<b>Operation</b> .....	8			
4.1	Overview of the controls.....	8			
4.2	Digital Information and Analysis System (DIA) .....	8			
4.3	Operating concept .....	9			
4.4	Basic display.....	10			
4.5	Operating levels .....	10			
4.6	Preparing for start-up.....	11			
4.7	Setting the heating flow temperature .....	13			
4.8	Hot water generation.....	14			
4.9	Setting a room thermostat or weather compensator .....	14			
4.10	Switching off the functions of the boiler .....	14			
4.11	Protecting the heating installation against frost....	16			
<b>5</b>	<b>Troubleshooting</b> .....	17			
5.1	Reading fault messages .....	17			
5.2	Reading fault codes.....	18			
5.3	Detecting and rectifying faults.....	18			
5.4	Rectifying low water pressure .....	19			
5.5	Resolving ignition faults.....	19			
5.6	Service message .....	20			
5.7	Resolving faults in the air/flue gas duct .....	20			
<b>6</b>	<b>Auxiliary functions</b> .....	20			
6.1	Operation in the menu.....	20			
6.2	Displaying the Live monitor (current status of the boiler).....	22			
6.3	Setting the display contrast .....	22			
6.4	Setting the language.....	22			
6.5	Displaying contact data for the competent person.....	23			
6.6	Displaying the serial number and article number .....	23			
6.7	Reset burner off time (resetting burner anti-cycling time) .....	23			
<b>7</b>	<b>Service</b> .....	23			
7.1	Servicing the boiler .....	23			
7.2	Caring for your boiler .....	23			

## 1 Notes on the documentation

The following instructions are intended to guide you throughout the entire documentation. Other documents apply in addition to these operating instructions. We accept no liability for any damage caused by failure to observe these instructions.

### Other applicable documents

When operating the ecoTEC plus, you must observe all operating instructions that are included with other components of your system.

These operating instructions are included with the individual components of the system.

Further instructions for all accessories and controllers used also apply.

The benchmark checklist for starting up gas-fired boilers (contained in the installation instructions) must be completed by the Health and Safety Executive-approved heating specialist company and/or the competent person present during the commissioning and must be passed on to the system operator. After reading through these instructions, if you have any questions regarding the operation of the boiler, please contact your recognised Health and Safety Executive-approved heating specialist company or Vaillant's technical department.

In these instructions, the heating specialist company and competent person approved by the Health and Safety Executive will be abbreviated as the heating specialist company and competent person.

### 1.1 Storing documents

- Store these operating instructions and all other applicable documents in such a way that they are available whenever required.

## 1.2 Applicability of the instructions

These operating instructions apply exclusively to boilers with the following article numbers:

Unit	Type designation	Article number
ecoTEC plus	VU GB 806/5-5	0010010767
ecoTEC plus	VU GB 1006/5-5	0010010780
ecoTEC plus	VU GB 1206/5-5	0010010791

### 1.1 Type overview

To find out the article number of your boiler, refer to the identification plate.

### 1.3 Identification plate

The identification plate of your Vaillant ecoTEC plus boiler is attached at the factory to the underside of your boiler. The seventh to sixteenth digits of the serial number on the identification plate represent the article number.

### 1.4 CE label



The CE label shows that the units comply with the basic requirements of the applicable directives as stated on the identification plate.

### 1.5 Benchmark



Vaillant Ltd. supports the Benchmark Initiative. A benchmark checklist for commissioning floor-standing gas-fired boilers is attached to these installation instructions. It is very important that this document be filled out properly when installing, commissioning and handing-over to the system operator.



## 2 Safety

### 2.1 Safety and warning information

- When operating your boiler, observe the general safety information and the warning notes that appear before each action.

#### 2.1.1 Classification of warnings

The warning notes are classified in accordance with the severity of the possible danger using the following warning signs and signal words:

Warning signs	Signal word	Explanation
	<b>Danger!</b>	Immediate risk of death or risk of severe personal injury
	<b>Danger!</b>	Risk of death from electric shock
	<b>Warning!</b>	Risk of minor personal injury
	<b>Caution!</b>	Risk of material or environmental damage

#### 2.1 Meaning of warning signs and signal words

#### 2.1.2 Structure of warnings

Warning signs are identified by an upper and lower separating line and are laid out according to the following basic principle:

**Signal word!****Type and source of danger.**

Explanation of the type and source of danger

- Measures for averting the danger

### 2.2 Intended use

The Vaillant ecoTEC plus boilers are state-of-the-art appliances which have been constructed in accordance with recognised safety regulations. Nevertheless, there is still a risk of injury or death to the operator or others or of damage to the boiler and other property in the event of improper use or use for which it is not intended.

This boiler is not designed to be used by persons (including children) with limited mental and sensory capabilities or by persons who do not have enough experience and/or knowledge, unless they are supervised by a person who is responsible for their safety or they have been instructed by him/her about how to use the boiler.

Children must be watched to ensure that they do not play with the boiler.

The boiler is intended for use as a heater in closed hot water central heating installations and hot water generation.

The use of the ecoTEC plus in vehicles, such as mobile homes and caravans, is not classed as intended use. Units that are not classed as vehicles are those that are installed in a fixed and permanent location and that do not have any wheels (fixed installation).

Any other use, or use beyond that specified, shall be considered improper use. Any direct commercial or industrial use is also deemed to be improper.

The manufacturer or supplier is not liable for any damage resulting from such use. In this case, the user alone bears the risk. Intended use includes:

- observance of accompanying operating, installation and maintenance instructions for the Vaillant product as well as for other parts and components of the system
- installation and assembly in accordance with the unit and system approval
- compliance with all inspection and servicing conditions listed in the instructions.

#### Caution

Any improper use is forbidden.

### 2.3 General safety information

- Observe the following safety instructions at all times.

#### Installation and settings

The boiler must only be installed by a suitably qualified competent person. The existing regulations, rules and guidelines must be observed when doing so. This person is also responsible for inspection, maintenance and repairs to the boiler, as well as alterations to the gas volume setting.

#### What to do if you smell gas in buildings

Installation errors, damage, manipulation, unauthorised installation sites or similar can cause gas to escape and result in a risk of poisoning and explosion. If there is a smell of gas in the building, proceed as follows:

- Avoid rooms that smell of gas.
- Open all accessible doors and windows fully and ensure adequate ventilation.
- Avoid the use of naked flames (e.g. lighters, matches).
- Do not smoke.
- Do not use any electrical switches, mains plugs, doorbells, telephones or other intercommunication systems in the building.
- Close the gas meter isolator device or the main isolator device.
- If possible, close the gas isolator cock on the boiler.
- Warn other occupants in the building by calling out or banging on doors or walls.
- Leave the building.
- If you can actually hear gas leaking, leave the building immediately and ensure that others do not enter the building.
- Alert the fire brigade and police when you are outside the building.
- Use a telephone outside the building to inform the emergency service department of the gas supply company.

National phone number for gas emergencies:  
0800 111 999

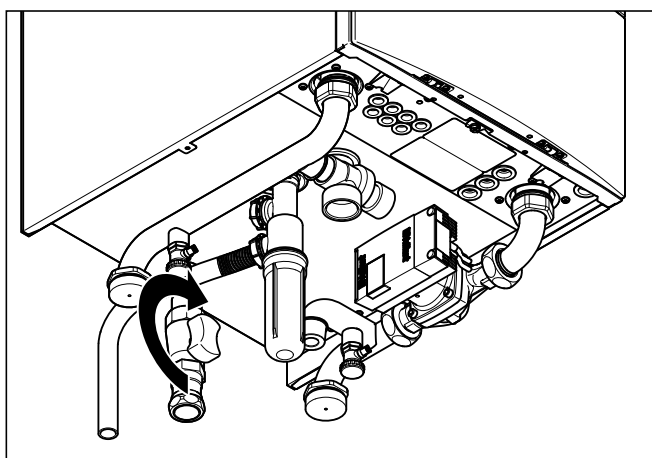

2.1 Close the gas isolator cock

#### What to do in an emergency if you smell flue gas

Installation errors, damage, tampering with the unit, unauthorised installation sites or similar can cause flue gas to escape and result in a risk of poisoning. If there is a smell of flue gas in the building, proceed as follows:

- Open all accessible doors and windows fully and ensure adequate ventilation.
- Switch the boiler off.
- Inform a heating specialist company.

#### Explosives and highly flammable substances

The risk of explosion arises from the flammable mixture of gas and air. Take note of the following:

- Do not use or store explosive or highly flammable substances (such as petrol or paint) in the same room as the boiler.

#### Preventing scalding

There is a risk of scalding at the hot water draw-off points if the hot water temperatures are greater than 60°C. Young children and elderly persons are particularly at risk, even at lower temperatures.

- Select the temperature so that nobody is at risk.

#### Preventing material damage due to unauthorised changes to the appliance.

Take note of the following:

- Never interfere or tamper with the boiler or other parts of the heating installation.
- Never try to carry out maintenance work or repairs on the boiler yourself.
- Do not damage or remove any seals on components.

Only suitably qualified competent persons or our customer service may alter sealed components.

#### Material damage caused by corrosion

To prevent corrosion on the boiler and also on the flue gas installation, note the following:

- Do not use any sprays, solvents, chlorinated cleaning agents, paint, adhesives or similar substances in the vicinity of the boiler.

Under unfavourable circumstances, these substances may cause corrosion.

#### Preventing frost damage

If there is a power cut, or if the room temperature is set too low in individual rooms, it cannot be ruled out that sections of the heating installation may be damaged by frost.

- If you are going to be away during a cold period, ensure that the heating installation remains in operation and that the rooms are sufficiently heated.
- Always observe the information on frost protection provided in (→ **section 4.11**)

Even if rooms, or the whole dwelling, are not in use for certain periods, the heating must remain in operation.



## 2 Safety



Caution.

Frost protection and monitoring devices are only active while the boiler is connected up to the power supply. The boiler must be connected to the power supply. The boiler must be switched on. You can see from symbols and/or text in the display that the boiler is switched on.

Caution.

- Under no circumstances should you add frost protection agents (or other additives, e.g. jointing compounds, corrosion protection agents, etc.) to the heating water without first consulting your qualified competent person. Otherwise, it could result in damage to seals and diaphragms as well as noise during heating mode. Vaillant assumes no liability for this or any consequential damage.

Another way to protect the heating installation and the boiler from frost is to drain them. In doing so, you must ensure that the heating installation and boiler are completely drained.

- Contact your approved heating specialist company for advice on this.

### **Maintaining operation with an emergency power generator in the event of a power cut**

Your recognised heating specialist company connected your boiler to the power mains during installation.

If the electricity supply is cut, it is possible that parts of the heating installation may become damaged by frost.

If you want to maintain the operation of the boiler during a power cut using an emergency power generator, take note of the following:

- Make sure that the technical values of this generator (frequency, voltage, earthing) match those of the power mains.
- Contact your approved heating specialist company for advice on this.

### **Changes to the boiler's environment**

You must not make any changes to the boiler's environment:

- Never shut down the safety devices.
- Do not tamper with any of the safety devices.
- Do not make any changes:
  - to the boiler
  - to the gas, air, water and electricity supply lines,
  - to the entire flue gas installation,
  - to the entire condensate drain system,
  - to the expansion relief valve or the drain line or
  - to constructional conditions that could affect the operational reliability of the boiler.

### **Cabinet-type cladding**

- If you require cabinet-type cladding for your boiler, consult an approved heating specialist company. Do not, under any circumstances, enclose your boiler yourself.

Enclosing the boiler in cabinet-type cladding requires compliance with the special design instructions.

### **What to do if there are leaks in the hot water pipes**

Take note of the following:

- In the event of leaks, immediately close the cold water stop valve in the domestic hot water pipework between the boiler and the draw-off points.
- Have the leak repaired by an approved heating specialist company of your choice.

With Vaillant ecoTEC plus boilers, the cold water stop valve is not included in the scope of delivery of your boiler.

- Ask your competent person where he fitted the cold water stop valve.

### **Preventing damage caused by low system pressure in the heating installation**

To prevent the heating installation being used when the amount of water is too low and to therefore prevent any subsequent damage that may be caused by this, note the following:

- Check the filling pressure of the heating installation at regular intervals.
- Always observe the information on filling pressure provided in → **section 4.6.3**.

### **Requirements for the installation site**

It is not necessary to keep a clearance between the boiler and combustible materials or components because, at the nominal heat output of your boiler, the temperature on the surface of the housing is always lower than the maximum permissible temperature of 85 °C.

### 3 Description of devices and functions

#### 3.1 Design

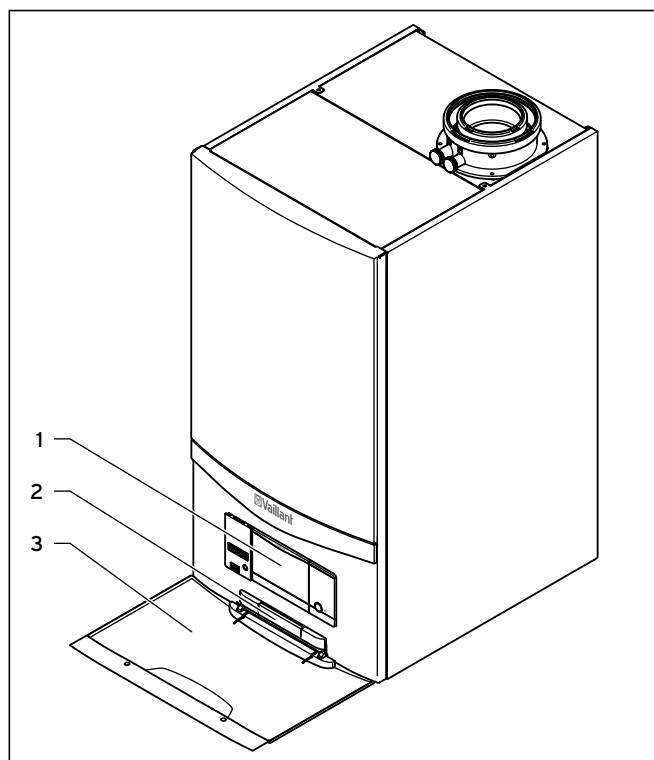

3.1 Front view of the ecoTEC plus

##### Key

- 1 Controls
- 2 Plate with serial number on the rear
- 2 Front flap

The controls for your boiler are arranged behind the front flap.

To access the controls, open the front flap as follows:

- Take hold of the recessed handle in the front flap.
- Fold down the front flap.

#### 3.2 Function

Your Vaillant ecoTEC plus is a gas-fired wall-hung high-efficiency boiler, which generates heat for heating and/or hot water production.

VU boilers can be operated together with a domestic hot water cylinder, which stores a larger volume of hot water.

##### 3.2.1 Heating mode

In Heating mode, the boiler heats the hot water and sends it through the radiators or underfloor heating of your home (heating circuit). The hot water pumped into the heating circuit exits the boiler at a specific heating flow temperature, emits its heat into the rooms and flows back into the boiler once cooled to return temperature. The heating water is then heated again.

##### 3.3 Hot water production with domestic hot water cylinder

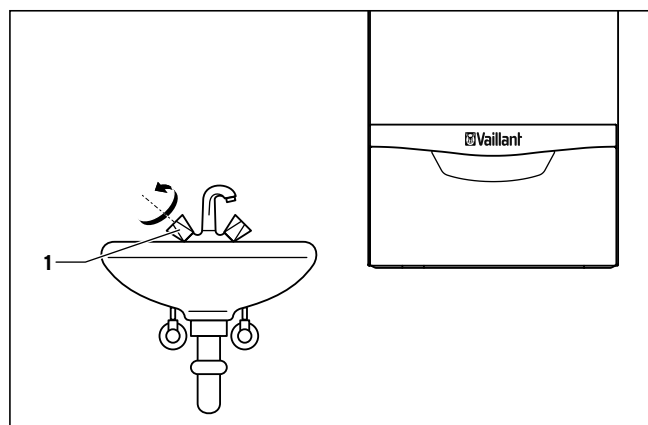

##### 3.2 Drawing hot water

When you open a hot water valve (1) (sink, shower, bath, etc.), the hot water is taken from the domestic hot water cylinder.

Cold water then flows into the domestic hot water cylinder in its place. If the hot water temperature in the domestic hot water cylinder falls below the value set, then the boiler operates automatically and reheats the domestic hot water cylinder. As soon as the water in the domestic hot water cylinder has reached the set temperature, the boiler switches off.

## 4 Operation

### 4 Operation

#### 4.1 Overview of the controls

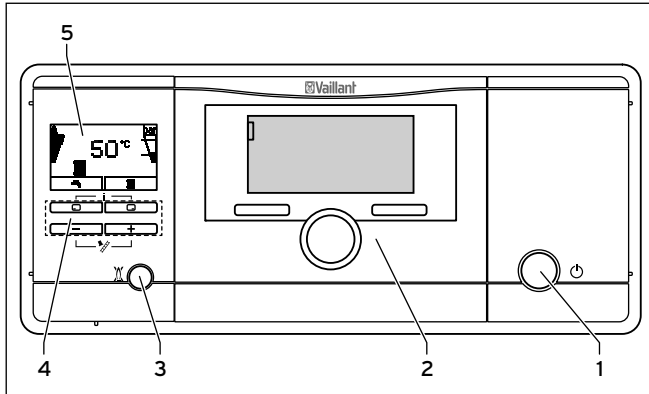

##### 4.1 ecoTEC plus controls

- 1 On/off button for switching the boiler on or off
- 2 Controller (accessory)

##### The Digital Information and Analysis System consists of:

- 3 Fault clearance key to clear certain faults
- 4 Operating buttons
- 5 Display

#### 4.2 Digital Information and Analysis System (DIA)

The ecoTEC plus boiler is equipped with a Digital Information and Analysis System (DIA system). This consists of a display showing symbols and plain text, along with 5 operation buttons. This system provides information on the operating status of your boiler and helps you deal with problems.

The display lights up,

- if you switch the boiler on or
- if you press a button for the DIA system when it is switched on. At first, pressing this button does not trigger any other function.

The light automatically switches off after one minute if you do not press any button.

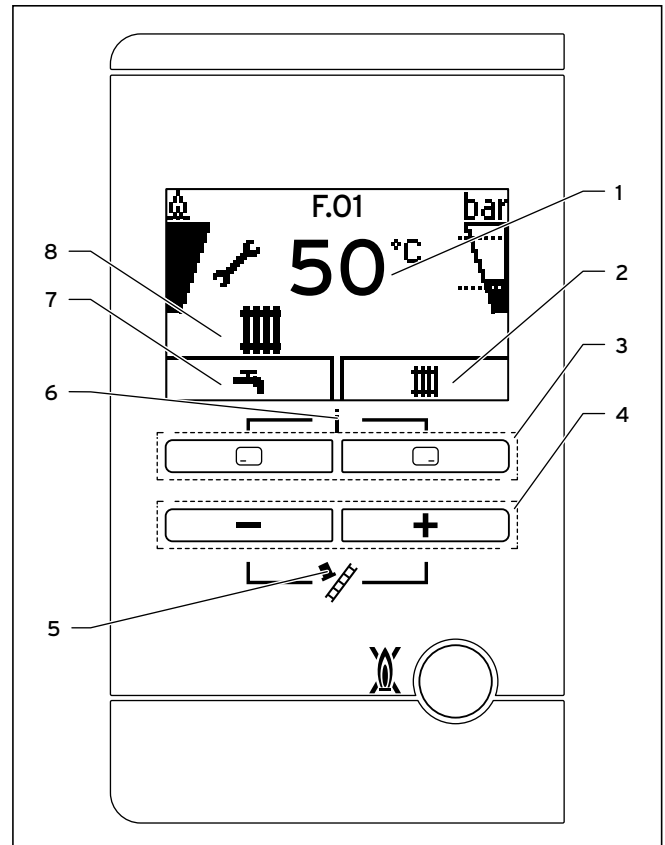

##### 4.2 DIA system with possible symbol displays

- 1 Display indicating the current heating flow temperature, the filling pressure of the heating installation, the operating mode, a fault code or other additional information in plain text
- 2 Display of the current configuration of the right-hand selector button (after switching on the boiler and in the basic display: = heating temperature)
- 3 Left and right-hand selector buttons  
Left-hand selector button: "Process water" for selecting and calling up the water temperature  
Right-hand selector button: "Heating mode" for selecting and calling up information, such as the heating temperature and water pressure in the heating circuit, for example
- 4 Minus and plus button
- 5 Maximum output mode (for chimney sweeps only)
- 6 Access to the menu for additional information
- 7 Display of the current configuration of the left-hand selector button (after switching on the boiler and in the basic display: = hot water temperature setting)
- 8 Display of the symbols for the active operating status



**Displayed symbols**



Flame:  
Permanently on: Correct burner operation; burner on

Display of the current burner modulation rate (bar graph display)



Display of the current filling pressure of the heating installation (bar graph display).

The filling pressure must be in the mid range between the two dotted lines.

Permanently on: The filling pressure is within the permitted range.

Flashing: The filling pressure is outside of the permitted range.



Heating mode active

Permanently on: Heating mode heat requirement

Flashing: Burner on in Heating mode



Hot water generation active

Permanently on: Time period activated for hot water generation

Flashing: Domestic hot water cylinder is being heated, burner on



Maintenance required. In the "Live monitor", you can read further information about the reason for the service (→ section 6.2).

Additional symbols:



Summer mode active  
Heating mode is switched off



Burner anti-cycling time active  
This function is used to prevent frequent on/off operations, and therefore contributes to prolonging the life of your boiler. The symbol also appears if the boiler is in a waiting period.



Fault in the boiler. Appears instead of the basic display (→ section 4.4).  
**F.XX** A plain text display explains the displayed fault code.  
Example; F.10 Flow NTC short circuit.

**4.3 Operating concept**

You can operate the boiler using the selector buttons and the plus/minus buttons.

Both selector buttons have a soft key function. This means that their function may change.

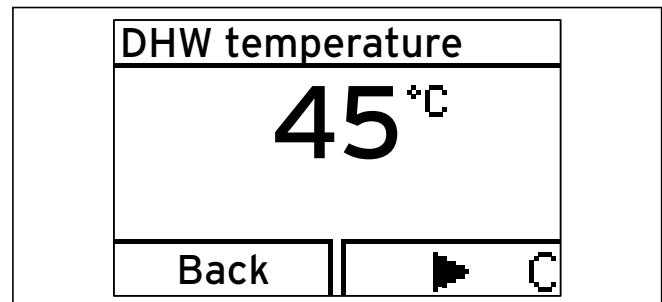

**4.3 Display after pressing the left-hand selector button**

If, for example, you press the left-hand selector button in the basic display (→ section 4.4), the current function switches from "H" (hot water temperature) to "Back".

With the left-hand selector button :

- you can navigate directly to set the hot water temperature
- you can cancel the change to a set value or the activation of an operating mode
- you can go one selection level higher in the menu



With the right-hand selector button :

- you can navigate directly to set the heating flow temperature and to the precise value of the water pressure of the heating installation
- you can confirm a set value or the activation of an operating mode
- you can go one selection level lower in the menu

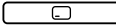
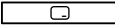
## 4 Operation

With both selector buttons  +  at the same time:

- you can navigate to the menu (→ **section 6**)

With the minus button  or the plus button  :

- you can go back and forth between the individual points of the entry list in the menu
- you can increase or decrease a selected set value

Adjustable values are always displayed as flashing. You must always confirm a change to a value. Only then is the new setting saved.

You always have the option to cancel the change to a setting or the reading of a value by pressing the left-hand selector button.

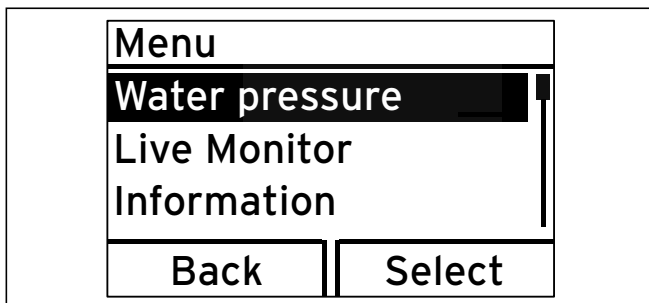

### 4.4 Selecting a list entry in the menu

A highlighted object is indicated in the display by the selected value flashing.



If you do not press any buttons for more than 15 minutes, the display returns to the basic display. Changes that are not confirmed will not be applied.

### 4.4 Basic display

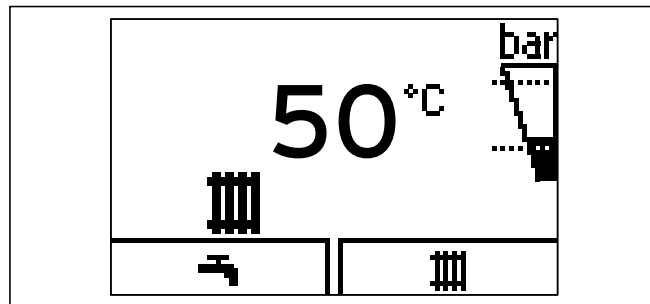

### 4.5 Basic display

In the normal operating status, you can see the basic display in the display. The basic display shows the current status of the boiler. If you press a selector button, the relevant activated function is displayed in the display. If the display becomes dark, the light is switched on by the first press of the button. In this case, to trigger the button function, you must press the button again.

You can switch back to the basic display by:

- pressing the left-hand selector button and exiting the selection levels
- not pressing any button for longer than 15 minutes. Changes that are not confirmed will not be applied.

If there is a fault message, the basic display switches to a plain text display of the fault message.

From the basic display, you can directly change and read the most important settings and information by pressing the selector buttons.

The functions that are available depend on whether a controller is connected to the boiler.

### 4.5 Operating levels

The boiler has two operating levels.

#### Operating level

The operating level for the operator offers you the most frequently used setting options that do not require any special prior knowledge and displays the most important information. You can access additional information using a menu.

#### Competent person level

The operating level for the competent person must only be operated with expertise and is therefore protected by a code. This level is used by the competent person to adjust the parameters for the boiler to the heating installation.

## 4.6 Preparing for start-up

### 4.6.1 Opening the isolator devices



The isolator devices are included in the scope of delivery of your boiler. The isolator devices are fitted by your competent person on site.

- He must explain to you the position and handling of these components.

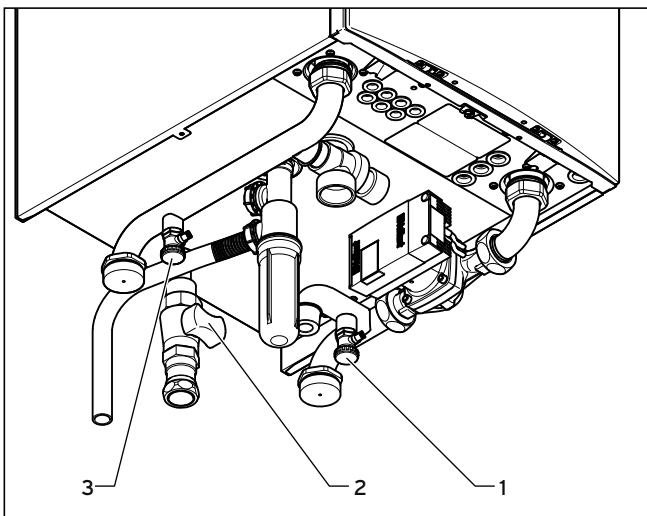

**4.6 Opening the isolator devices**  
(shown using the example of service valves)

- Open the gas isolator cock (2), by pushing the gas isolator cock in and turning it anti-clockwise.
- Check that the heating flow (3) and heating return (1) service valves are open. This is the case if the T-handle on the service valve matches the direction of the pipe.

### 4.6.2 Switching on the boiler



**Caution.**

**Material damage caused by frost.**

Frost protection and monitoring devices are only active while the boiler is connected up to the power supply.

- Do not isolate the boiler from the power supply.
- Leave your boiler switched on at the on/off switch.

To ensure that the frost protection and monitoring devices remain active, switch your boiler on and off using the controller (see the corresponding operating instructions).

→ **Section 8** describes how to fully shut down your boiler.

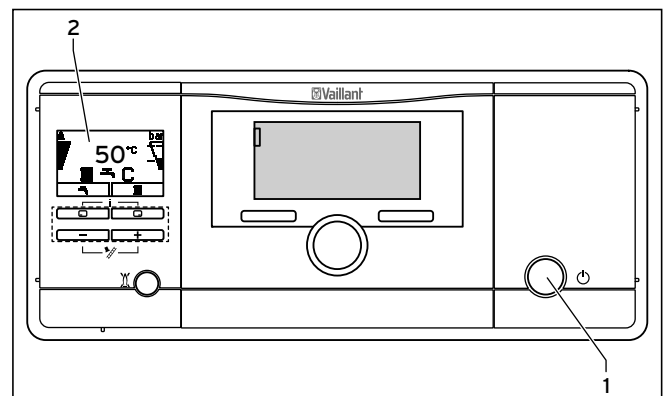

**4.7 Switching on the boiler**

- Press the on/off switch (1) to switch on the boiler.

If the boiler is switched on, the current heating flow temperature and other information will appear in the display (2) (Fig. 4.5).

To set your boiler to suit your needs, read **section 4.7** to **section 4.8** which describe the setting options for hot water generation and Heating mode.

## 4 Operation

### 4.6.3 Checking the filling pressure of the heating installation



**Caution.**  
**Low filling pressure may cause damage to the unit.**

Operating the heating installation with low filling pressure can cause damage to the boiler and the heating installation. The boiler switches off automatically when the filling pressure falls too low.

- Fill up the heating installation as soon as the filling pressure falls below 0.08 MPa (0.8 bar).

To avoid operating the system with insufficient water and to prevent possible damage associated with this, your boiler is fitted with a pressure sensor. This signals the low pressure level if the level falls below 0.08 MPa (0.8 bar) by the water pressure value in the display flashing.

- Fill up the heating installation as soon as the pressure value in the display starts to flash. (→ **section 4.6.4**).



If the filling pressure of the heating installation falls below 0.05 MPa (0.5 bar), then the boiler switches off and the fault message **F.22** appears in the display.

The ecoTEC plus boiler has a digital pressure display. You can see the filling pressure in the right bar graph display or display the exact value using the selector buttons to the right of the display.

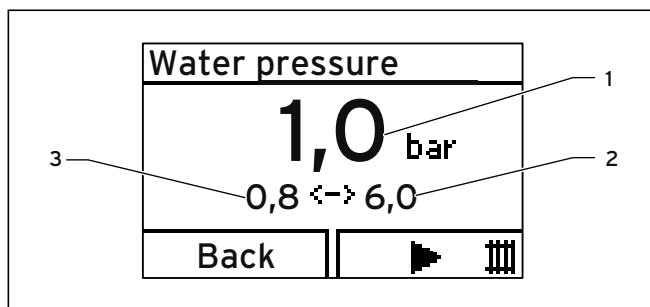

**4.8 Digital display of filling pressure**

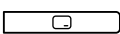
- Press the on/off switch (1) (→ **Fig. 4.7**), to switch on the boiler
- Press the right-hand selector button  twice. ("▮")

The value of the flow temperature appears in the display.

Press the right-hand selector button to access the water pressure display.

The current filling pressure (1) and the minimum (3) or maximum water pressure (2) that is to be set appear in the display.

If the heating installation extends over several storeys, a higher filling pressure may be required for the heating installation.

- Ask your competent person for details.

The filling pressure must lie between 0.01 MPa (1.0 bar) and 0.04 MPa (4.0 bar) when the heating installation is cold in order for the heating installation to operate properly. If the filling pressure is below this range, then you must top up the water before start-up.

- Check the filling pressure of the heating installation during start-up.

### 4.6.4 Filling the heating installation



**Caution.**

**Tap water that is extremely calciferous or corrosive or contaminated by chemicals can cause damage to the boiler.**

Unsuitable tap water damages the seals and diaphragms, blocks components in the boiler and heating installation through which the water flows and causes noise. The heating installation must be hydraulically separated from the unit using a plate heat exchanger. If the heating installation and boiler are operated with a system separation device, water treatment will not be necessary up to a hardness of 4.48 mol/m<sup>3</sup> (448 mg/l). Should there be good grounds not to use a system separation device, the heating water must be processed according to strict guidelines. This must take place in a treatment plant.

- Only fill the heating installation with suitable water. The calcium content of the water should not exceed the following hardness in relation to the stated system volumes:

- 1000 l: up to 1.09 mol/m<sup>3</sup> (109 mg/l)
- 2000 l: up to 0.55 mol/m<sup>3</sup> (55 mg/l)
- 4000 l: up to 0.26 mol/m<sup>3</sup> (26 mg/l)
- 7200 l: up to < 0.14 mol/m<sup>3</sup> (14 mg/l)

To this end, both the water used for initial filling and the water for any top-ups must be treated.

- In case of doubt, consult your competent person.

The heating installation is filled via a filling cock provided by the installer (if a system separation device is used between the unit heating circuit and the building heating circuit).

- Ask your competent person where the filling cock is located.
- Ask your competent person to explain how to fill the heating installation.

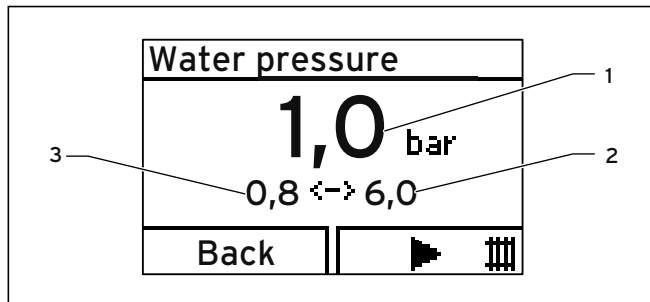

**4.9 Digital display of filling pressure**

You can show the exact filling pressure in the display (→ **section 4.6.3**).

Proceed as follows to fill the heating installation (building heating circuit):

- Open all radiator valves (thermostatic radiator valves) of the heating installation.
- Connect the filling cock for the heating installation, as explained by your competent person, to a filling system.
- Open the filling cock slowly.
- Fill it with water until the required filling pressure is reached in the display.
- Close the filling system valve.
- Purge all the radiators.
- Then check the filling pressure on the display.
- Fill with more water if required.
- Close the filling cock.

When filling the unit heating circuit, the filling pressure profile can be tracked on the unit display

- Press the "Next" or "Back" selector button until you have reached the desired level or the basic display.

If you do not press any buttons for more than 15 minutes, the display returns to the basic display.

## 4.7 Setting the heating flow temperature

### 4.7.1 Setting the heating flow temperature without a controller connected

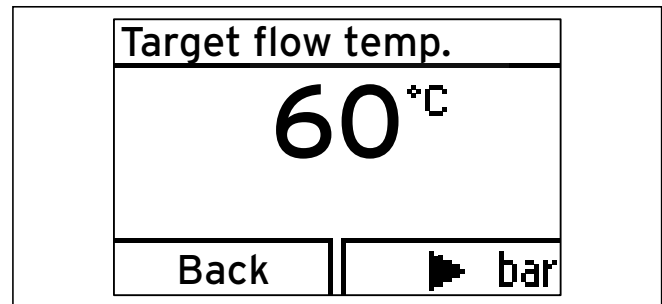



**4.10 Setting the heating flow temperature**

If no external controller is connected to the boiler, set the heating flow temperature according to the respective outside temperature as follows:

- Press the on/off switch to switch on the boiler.
- Press the right-hand selector button  ("OK").

The value of the heating flow temperature appears in the display.

- Use the minus button  or the plus button  to change the heating flow temperature.
- Confirm the change by pressing the right-hand selector button  ("OK").

The heating flow temperature is factory-set for temperatures up to 75°C.

If higher (or lower) values can be set on your boiler, this means that your competent person has calibrated your unit to adjust the maximum temperature to your heating installation.

### 4.7.2 Using a controller to set the heating flow temperature

If your gas-fired wall-hung boiler has a room thermostat control system or weather compensator, make the following settings:

- Press the on/off switch to switch on the boiler.
- Set the maximum heating flow temperature (→ **section 4.7.1**).

The actual heating flow temperature is automatically adjusted by the controller (for information about this, see the controller operating instructions).

## 4 Operation

### 4.8 Hot water generation



#### **Danger!**

#### **Risk of being scalded by hot water!**

There is a danger of scalding at the hot water draw-off points when the temperatures are in excess of 60 °C. Young children and elderly persons are particularly at risk, even at lower temperatures.

- Select the temperature so that nobody is at risk.



#### **Danger!**

#### **Possible risk of death caused by legionella formation!**

In domestic hot water cylinders there is a risk of legionella forming, which can cause illness.

- If the unit is used for post-heating within a solar-supported drinking water heating installation, set the domestic hot water outlet temperature to at least 60 °C.



#### **Caution.**

#### **Material damage due to calcification.**



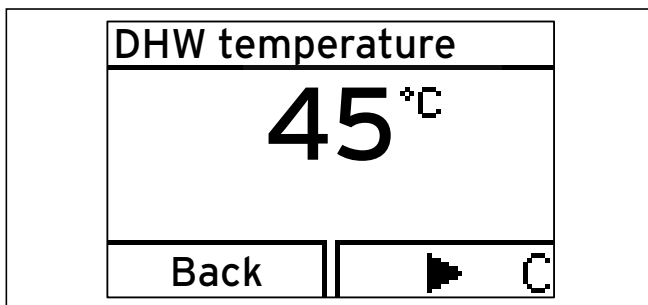

If the water hardness is more than 3.57 mol/m<sup>3</sup> (=357 mg/l), there is a risk of calcification.

- Set the maximum water temperature to 50 °C.

To generate hot water in conjunction with the VU unit type, a VIH-type domestic hot water cylinder must be connected to the boiler.

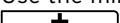

#### 4.11 Setting the hot water temperature

- Press the on/off switch to switch on the boiler.
- Press the left-hand selector button  ("←"). The hot water temperature that is set is shown flashing on the display.
- Use the minus button  or the plus button  to change the hot water temperature.
- Confirm the change by pressing the right-hand selector button  ("OK").

If your controller is connected to the boiler via a dual-cable eBUS line, you can set the target hot water target temperature on the controller. Ask your competent person whether or not your controller is connected via a dual-cable eBUS line.

If your controller is connected via a dual-cable eBUS line:

- Set the hot water temperature on the boiler to the maximum possible temperature.
- Set the desired hot water temperature

### 4.9 Setting a room thermostat or weather compensator

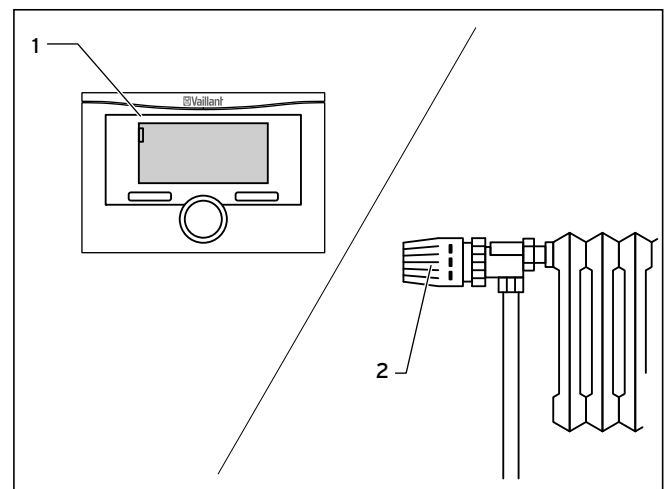

#### 4.12 Setting the room thermostat/weather compensator

- Set the room thermostat, weather compensator (1) and thermostatic radiator valves (2) as specified in the operating manuals for these accessories.

### 4.10 Switching off the functions of the boiler

#### 4.10.1 Switching off hot water generation (VU boiler)

If a domestic hot water cylinder is connected, you can switch off the cylinder charging without switching off Heating mode.

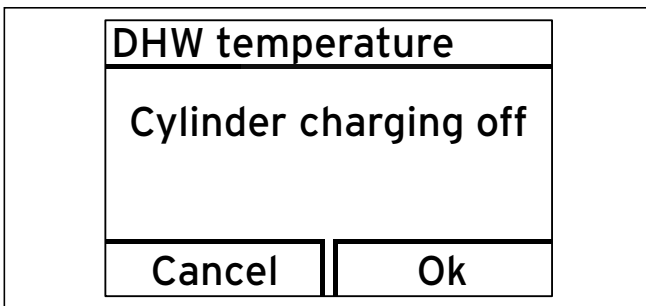

**4.13 Switching off cylinder charging**

- Press the left-hand selector button ("←"). The domestic hot water temperature that is set is shown flashing on the display.
- Use the minus button to set the hot water temperature to "Cylinder charging off"
- Confirm the change by pressing the right-hand selector button ("OK").

Cylinder charging is switched off. Only the frost protection function for the cylinder remains active.

To switch the cylinder charging on again:

- Use the plus button to set your required hot water temperature.
- Confirm the change by pressing the right-hand selector button ("OK").

**4.10.2 Switching off Heating mode (Summer mode)**

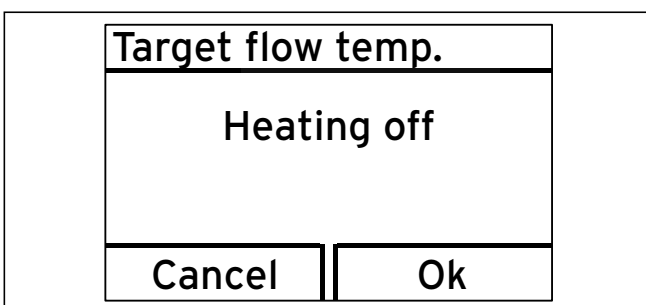

**4.14 Switching off Heating mode (Summer mode)**

You can switch off Heating mode in summer without switching off the hot water generation.

- Press the right-hand selector button ("OK"). The value of the heating flow temperature appears in the display.
- Use the minus button to set the heating flow temperature to "Heating off".
- Confirm the change by pressing the right-hand selector button ("OK").

Heating mode is switched off. The symbol appears on the display.

To switch Heating mode on again:

- Use the plus button to set your required heating flow temperature.
- Confirm the change by pressing the right-hand selector button ("OK").

**4.10.3 Temporarily shutting down the boiler**



**Caution.**

**Risk of damage caused by frost.**

Frost protection and monitoring devices are only active while the boiler is connected up to the power supply and the on/off switch is on.

- Do not isolate the boiler from the power supply.
- Leave your boiler switched on at the on/off switch.
- Only switch the boiler on and off in normal mode using the controller.
- Make sure that the boiler cannot become damaged by frost.

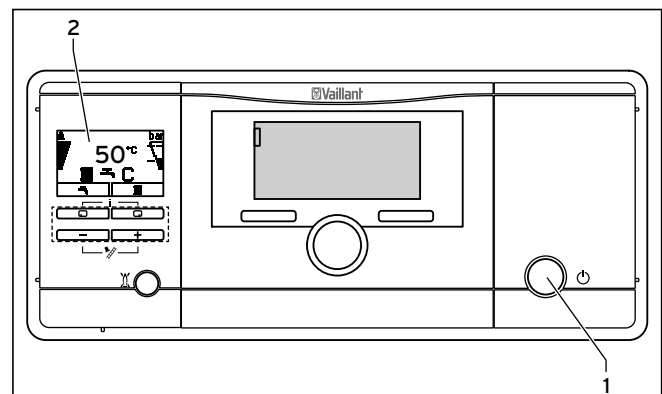

**4.15 Switching off the boiler**

- Press the on/off switch (1) to switch off the boiler.

If the boiler is switched off, the display (2) turns off.



If the boiler is going to be decommissioned for longer periods (e.g. holiday), you should also close the gas isolator cock and the cold water stop valve, but only if there is no risk of frost.



The isolator devices are included in the scope of delivery of your boiler. These are fitted by your competent person on site.

- Ask your competent person to explain to you the position and handling of these isolator devices.

## 4 Operation

### 4.11 Protecting the heating installation against frost



**Caution.**  
**Risk of damage caused by frost.**

Frost protection and monitoring devices are only active while the boiler is connected up to the power supply and the on/off switch is on.

- Do not isolate the boiler from the power supply.
- Leave your boiler switched on at the on/off switch.



**Caution.**  
**Tap water that is extremely calciferous or corrosive or contaminated by chemicals can cause damage to the boiler.**

Unsuitable tap water damages the seals and diaphragms, blocks components in the boiler and heating installation through which the water flows and causes noise.

- The boiler must be equipped with a system separation device (plate heat exchanger). Due to the low water content, special water treatment for the primary circuit is no longer necessary.

The heating installation and water pipes are sufficiently protected against frost if the heating system remains on and the rooms are sufficiently heated while you are away.

#### 4.11.1 Activating the frost protection function

Your QQQQVaillant ecoTEC plus boiler is equipped with a frost protection function:

If the heating flow temperature falls below 5 °C when the main switch is on, the boiler comes into operation and heats the circulating water to approx. 30 °C.



**Caution.**  
**Risk of damage caused by frost.**

The frost protection function cannot guarantee flow through the entire heating installation, which means that parts of the heating installation may freeze and become damaged.

- Make sure that the boiler remains on whilst you are away.
- Make sure that the rooms are heated sufficiently.

#### 4.11.2 Draining the heating installation

Another way to protect the heating installation and the boiler from frost when they are switched off for a very long time is to drain them. You must ensure that the heating installation and boiler are completely drained.

All the cold and hot water pipes in the house and in the boiler must also be drained.

- Ask your competent person to drain the heating installation.



## 5 Troubleshooting



**Danger!**  
**Risk of injury and material damage due to incorrect maintenance and repairs!**

If maintenance is not carried out, or it is carried out incorrectly, this may adversely affect the operational reliability of your boiler.

- Never attempt to perform maintenance or repairs on your boiler by yourself.
- You must employ an approved heating specialist company or Vaillant Service Solutions (0870 6060 777). to complete such work.

### 5.1 Reading fault messages

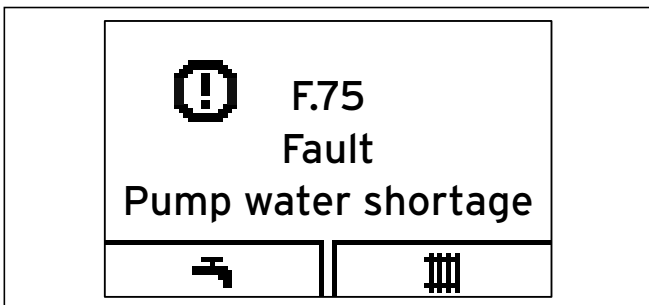

#### 5.1 Fault display

Fault messages have priority over all other displays. If a fault develops in the boiler, the display shows a fault code instead of the basic display. A plain text display explains the displayed fault code.

Example for F.75: "Fault Pump water shortage".

If multiple faults occur at the same time, the display shows the corresponding fault codes for two seconds each in sequence.

- If your boiler displays a fault message, contact your approved competent person.

You can use the "Live monitor" function to call up status messages about the status of your boiler (→ **section 6.2**).

## 5 Troubleshooting

### 5.2 Reading fault codes

If a fault develops in the boiler, the display shows a fault code starting with "F...". A plain text display explains the displayed fault code. Example for F.10 "Flow NTC short circuit". Fault codes have priority over all other displays. If a fault occurs, the display no longer shows the current heating flow temperature. If multiple faults occur at the same time, the display shows the corresponding fault codes for two seconds each in sequence.

- If your boiler displays a fault code, contact your competent person.

### 5.3 Detecting and rectifying faults

If problems occur whilst operating your boiler, you can carry out the following self-checks:

Problem	Possible cause	Solution
No hot water, heating stays cold; boiler does not start	Building gas isolator cock closed	Open building gas isolator cock (→ <b>section 4.6.1</b> )
	Building power supply switched off	Switch on building power supply
	Mains switch on boiler switched off	Switch on the mains switch on the boiler (→ <b>section 4.6.2</b> )
	The heating flow temperature is set too low or in the "Heating off" position (→ <b>section 4.7.2</b> ) and/or the hot water temperature is too low	Set the heating flow temperature to the desired temperature (→ <b>section 4.7</b> ) and/or set the domestic hot water temperature to the desired temperature (→ <b>section 4.8</b> )
	Filling pressure of the heating installation too low	Top up the heating installation with water (→ <b>section 4.6.4</b> )
	Air in the heating installation	Purge the radiators; If the problem occurs again: Contact your competent person
	Ignition malfunction	Press the reset button; If the problem occurs again: Contact your competent person (→ <b>section 5.5</b> ).
DHW mode without any problems; Heating does not start	No heat requirement via the controller	Check the timer programme on the controller and correct if necessary; Check the room temperature and, if required, correct the target room temperature (→ <b>section 4.9; Controller operating instructions</b> ).

#### 5.1 Detecting and rectifying faults

- If, after checking the points mentioned in **Table 5.1**, your boiler still shows signs of a fault, contact your competent person to eliminate the problem.

### 5.4 Rectifying low water pressure



**Caution.**  
**Tap water that is extremely calciferous or corrosive or contaminated by chemicals can cause material damage.**

Unsuitable tap water damages the seals and diaphragms, blocks components in the boiler and heating installation through which the water flows and causes noise.

- Only fill the heating installation with suitable heating water.
- In case of doubt, consult your competent person.

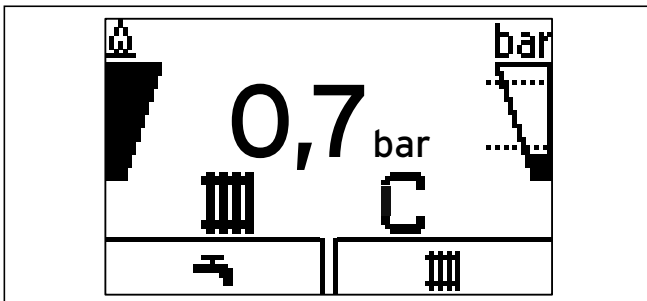

**5.2 Display of the filling pressure for the heating installation is too low**

If the filling pressure for the heating installation falls below 0.08 MPa (0.8 bar), the red bar display and the current filling pressure flash in the display.

If the pressure falls below 0.05 MPa (0.5 bar), the boiler switches off and the fault message F.22 appears in the display. To restart the boiler, you must refill the heating installation with treated water (→ section 4.6.3 and 4.6.4).

As soon as the system has been topped up with sufficient water, the message disappears automatically after approx. 20 seconds. If the pressure drops frequently, the reason for the loss of hot water must be identified and eliminated

- Contact your competent person.

If the heating installation extends over several storeys, a higher filling pressure may be required for the heating installation.

- Ask your competent person for details about this.

To fill up and to re-fill the heating installation, you can normally use tap water. In exceptional cases, however, the water quality may not be suitable for filling the heating installation because the water is highly corrosive or calciferous.

- If this is the case, contact your competent person.

### 5.5 Resolving ignition faults



**Caution.**  
**Risk of damage due to improper modifications.**

Improper modifications or persistent faults can result in material damage.

- If you are unable to resolve the ignition problem yourself by resetting the boiler three times, consult your competent person.

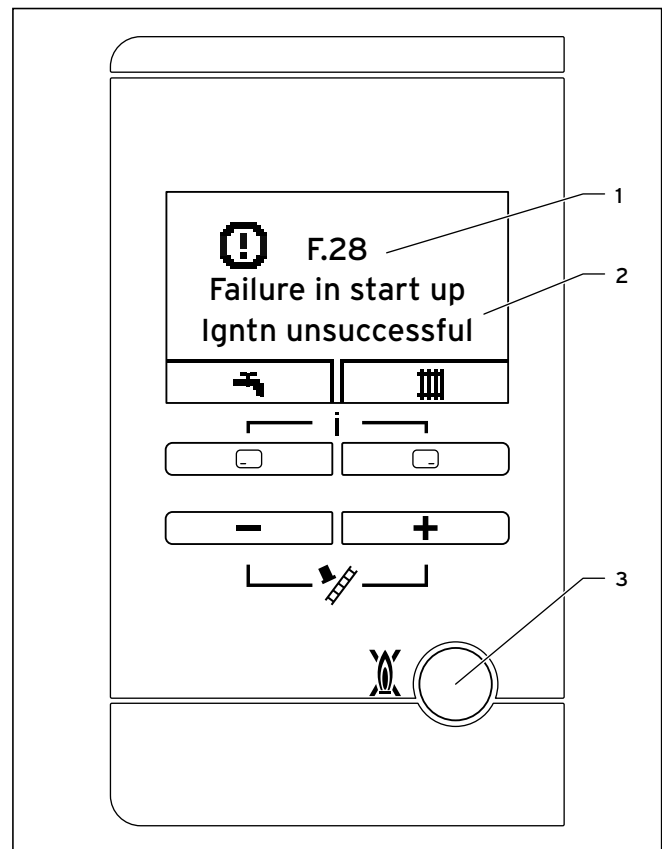

**5.3 Fault clearance**

If the burner fails to ignite after five attempts, the boiler will not operate and switches to "Fault". This is indicated by the display of fault codes "F.28" or "F.29" (1) and an accompanying plain text display in the display, e.g. for F.28: "Failure during start-up, Ignition failed" (2).

On Vaillant ecoTEC plus boilers, a crossed-out flame symbol is also displayed along with the relevant plain text in the display, e.g. for F.28:

"Failure in start-up: Ignition unsuccessful" (2). The boiler will only ignite automatically again once you have reset it manually.

- To reset the boiler manually, press the reset button (3) and hold for one second.

## 6 Auxiliary functions

### 5.6 Service message

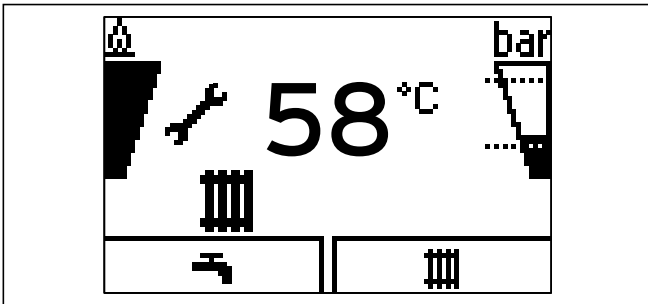

#### 5.4 Service message

If the open-ended spanner is displayed, the boiler requires a service.

- Consult your competent person about doing this. The boiler is not in fault mode but continues to operate.
- In the "Live monitor", you can read further information about the reason for the service (→ **section 6.2**).
- If your boiler shows that it is working in the Comfort safety mode, contact your approved competent person.
- Inform the approved competent person of the status code that is displayed.



If the water pressure is shown flashing at the same time (→ **section 5.4**), you only have to top up the water (→ **section 4.6.3 and 4.6.4**).

### 5.7 Resolving faults in the air/flue gas duct



**Danger!**  
**Risk of injury and material damage resulting from improper modifications!**  
 Improper modifications can affect the operating safety of your boiler.

- Never attempt to perform repairs on your boiler by yourself.
- Always employ a competent person.

The boilers are fitted with a fan. If the fan does not work properly, the boiler will switch itself off. The fault message "F.32" appears in the display. The displayed fault code is additionally explained by a corresponding plain text message in the display: "Fault: Fan".

## 6 Auxiliary functions

The digital information and analysis system provides you with further functions via the menu.

### 6.1 Operation in the menu

You can access this menu by pressing both selector buttons ("i") at the same time.

#### 6.1.1 Structure of the menu

In addition to the direct operation via the selector buttons from the basic display menu, the digital information and analysis system has a menu that, in turn, has two selection levels (sublevels).

Through the selection levels, you navigate to the display and setting levels in which you can read or change settings. The selection levels have four display fields.

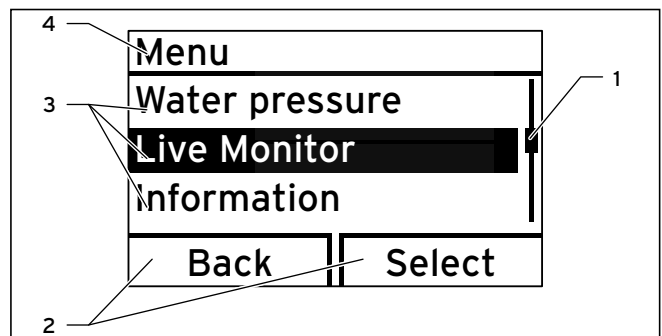

#### 6.1 Display fields in the menu

##### Key

- 1 Scroll bar (only if there are more list entries than can be shown at once on the display)
- 2 Current functions of the right and left-hand selector buttons (soft key functions)
- 3 List entries for the selection levels
- 4 Name of the selection level



In the following, path details at the beginning of an instruction specify how to access this function, e.g. **Menu → Information → Contact data**.

6.1.2 Overview of the menu structure

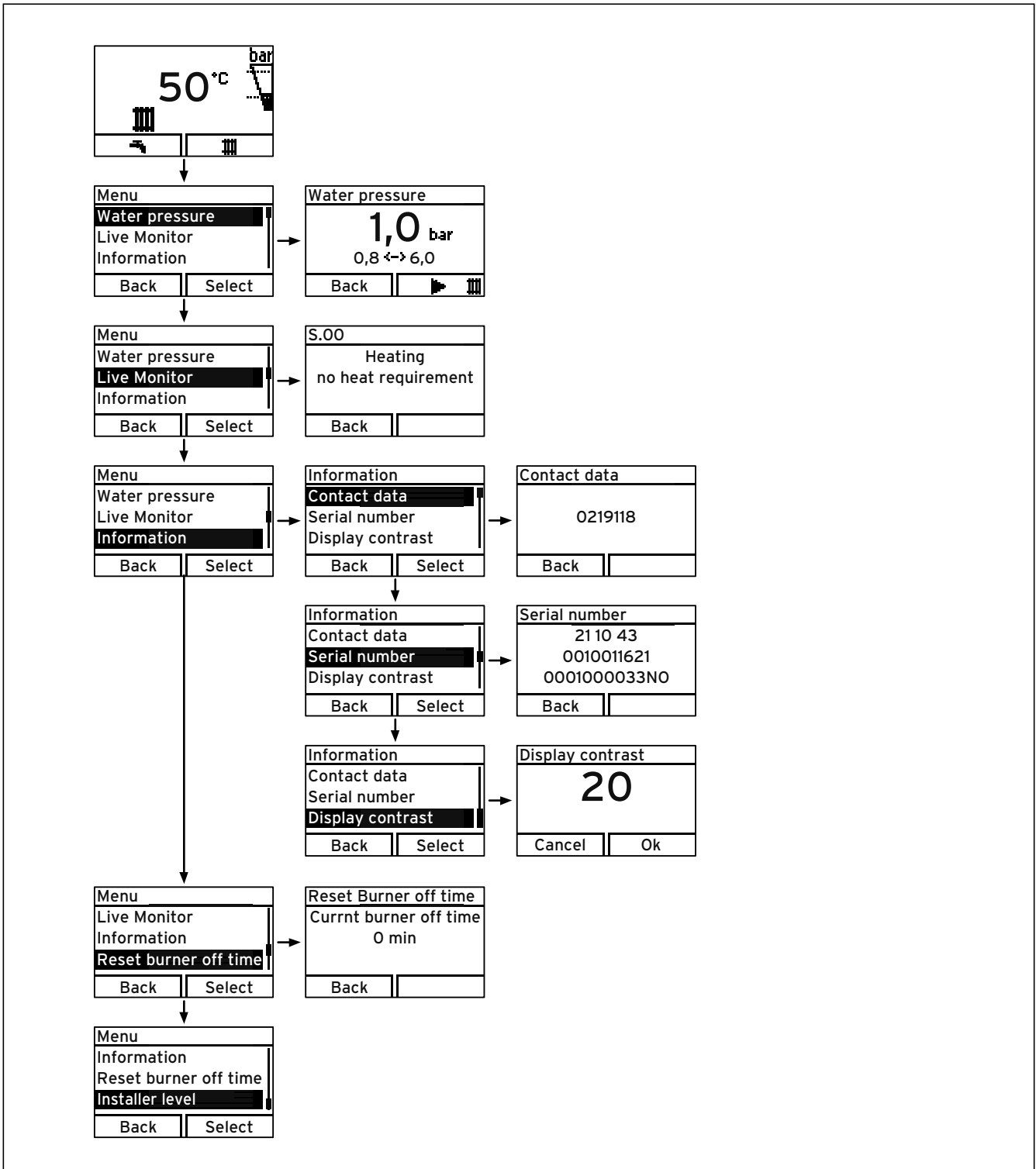

6.2 Overview of the menu structure

## 6 Auxiliary functions

### 6.2 Displaying the Live monitor (current status of the boiler)

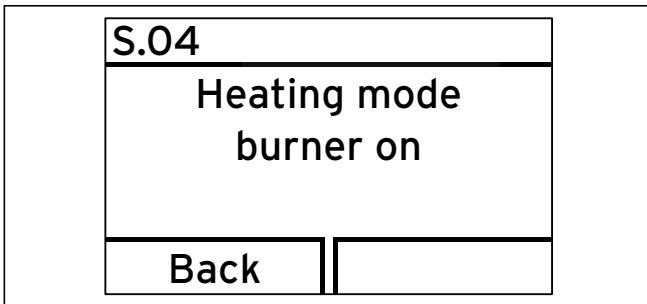

6.3 Live monitor (current status of the boiler, example)

#### Menu → Live Monitor

This function allows you to display the current status of your boiler. In addition, the meaning of the message is displayed as plain text.

The display is automatically updated if the boiler status changes.

Status codes	Meaning
	<b>Displays in Heating mode</b>
S 00	Heating mode: No heat demand
S 02	Heating mode: Water pump running
S 03	Heating mode: Ignition sequence
S 04	Heating mode: Burner ignited
S 06	Heating mode: Fan overrun
S 07	Heating mode: Pump overrun
S 08	Heating mode: Remaining anti-cycling time xx min
	<b>Displays in cylinder charging mode</b>
S 20	Warmstart demand
S 22	DHW mode: Pump running
	<b>Special cases</b>
S 31	No heat demand, summer operating mode
S 34	Heating mode: frost protection

6.1 Status codes and their meaning (selection)

### 6.3 Setting the display contrast

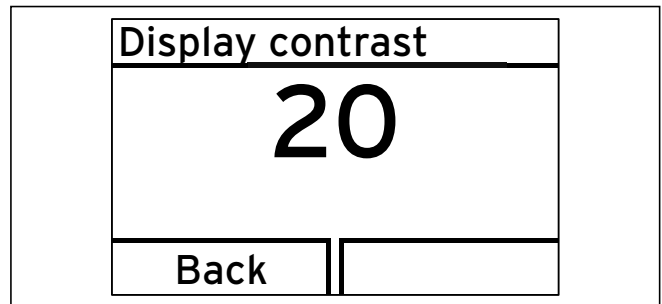

6.4 Setting the display contrast

#### Menu → Information → Display contrast

Using this function, you can set the display contrast in relation to the brightness of the surroundings to ensure that the display is clearly legible.

### 6.4 Setting the language

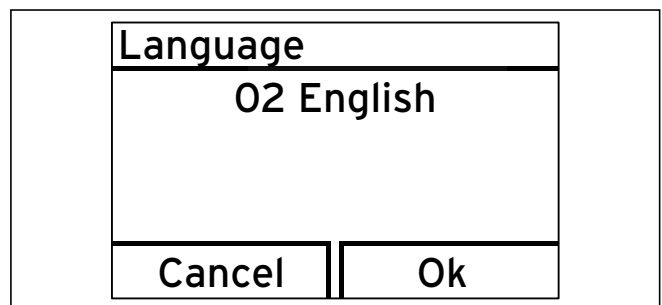

6.5 Setting the language

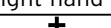
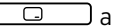
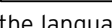
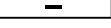
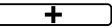
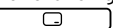

Your competent person should have set the boiler to your desired language. If you wish to set another language, you can proceed as follows:

- > Press **and hold** the right-hand selector button  and the plus button  **at the same time**.
- > **Also** press the fault clearance key briefly.
- > **Continue to press and hold** the right-hand selector button  and the plus button  until the display offers you the option to set the language.
- > Use the minus button  or plus button  to select your desired language.
- > Confirm the change by pressing the right-hand selector button  ("OK").

You must confirm the set language twice to ensure that you have not accidentally set an incorrect language.

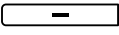

If you have accidentally set a language that you cannot understand, you can change this as described above.

- Use the minus button  or plus button  to scroll until your language appears.

### 6.5 Displaying contact data for the competent person

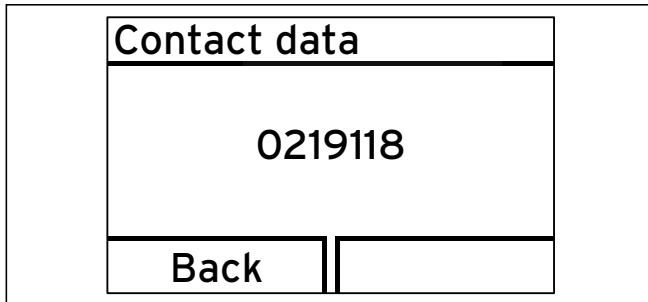

#### 6.6 Displaying contact data

**Menu → Information → Contact data**

If your competent person has entered their telephone number during the installation, you can read this data under "Contact data".

### 6.6 Displaying the serial number and article number

**Menu → Information → Serial number**

"Serial number" shows the serial number of the boiler, which the approved competent person may require from you.

The article number is found in the second line of the serial number.

The serial numbers are also located on a plate, which is stuck behind the front flap on the underside of the boiler in a plastic fish plate.

### 6.7 Reset burner off time (resetting burner anti-cycling time)

**Menu structure → Reset burner off time**



This function must only be operated by your competent person.

## 7 Service



### **Danger!**

#### **Risk of injury and material damage due to incorrect maintenance and repairs!**

If maintenance is not carried out, or it is carried out incorrectly, this may adversely affect the operational reliability of your boiler.

- Never attempt to carry out maintenance work or repairs on your boiler by yourself.
- Always employ a competent person.

### 7.1 Servicing the boiler

Permanent operational readiness and safety, reliability and a long working life require inspections and maintenance work to be carried out annually on the boiler by a competent person.

Regular servicing ensures maximum efficiency and a more economical operation of your boiler.

We recommend making a maintenance agreement.

### 7.2 Caring for your boiler



#### **Caution.**

#### **Unsuitable cleaning agents can cause damage.**

Unsuitable cleaning agents (scouring or other cleaning agents) can damage the exterior, the fittings or the controls.

- Do not use sprays, solvents or cleaning agents containing chlorine.

- Clean the exterior of your boiler with a damp cloth and a little solvent-free soap. Do not use any detergent.

## 8 Decommissioning

### 8 Decommissioning

- Contact a competent person to disconnect the boiler permanently.

#### 8.1 Disposing of the boiler

Do not dispose of your Vaillant ecoTEC plus boiler or any of its accessories in the household waste.

- Make sure the old unit and any accessories are disposed of properly.
- Observe valid national regulations.

#### 8.2 Disposing of the packaging

Arrange for the competent person who installed the boiler to dispose of the transport packaging.

### 9 Manufacturer's guarantee and Vaillant customer services

#### 9.1 Factory guarantee

##### **Two year guarantee for ecoTEC plus appliances**

Vaillant undertakes to rectify any manufacturing defect that occurs within twenty-four months of the installation date.

For the 2nd year of the guarantee to be valid an annual service must be carried out by a competent person approved at the time by the Health and Safety Executive one year after installation.

The cost of this annual service is not included in the guarantee.

##### **Registering with us**

Registration is simple. Just complete the Guarantee Registration Card and return to Vaillant within 30 days of installation. Your details will then be automatically registered within the Vaillant scheme.

Note: No receipt will be issued.

##### **Immediate help**

If your Vaillant boiler develops a fault your first action should be to contact your installer, as his professional assessment is needed under the terms of our Guarantee. If you are unable to contact your installer, phone Vaillant Service Solutions: 0870 6060 777

#### 9.2 Vaillant Service

To ensure regular servicing, it is strongly recommended that arrangements are made for a Maintenance Agreement. Please contact Vaillant Service Solutions (0870 6060 777) for further details.



## 10 Glossary

### Air/flue gas duct

The air/flue gas duct consists of all components that route combustion air to the boiler or flue gas away from the boiler.

### Burner

The burner on a gas-fired condensing boiler is the component on whose surface the gas/air mix is control-burnt.

### Calorific value

Unlike the heating value, the calorific value of a fuel describes the total usable heat during combustion, based on the quantity of fuel used, including the condensation heat in the steam. Condensing boilers use this additional condensation heat to achieve considerably higher efficiency levels than conventional boilers.

### Controller

The controller is the interface to the boiler, by means of which you can adjust, for example, the room temperature, the hot water temperature, the heating times or the night set-back phase in accordance with your requirements and wishes.

A distinction is made between room thermostat, weather compensator and solar control.

### Cylinder charging

Cylinder charging mode refers to the process of heating up the cylinder. See also hot water generation.

### Dew point

The dew point is the temperature at which steam turns to liquid (condensation). The steam in the flue gas from the boiler contains thermal energy, which can be released by condensation. In gas-fired and oil-fired boilers using calorific values, the flue gases are cooled so that the steam condenses and the heat that it contains can be output into the heating system.

### eBUS

The abbreviation eBUS is short for energyBUS.

The eBUS is a special cable system used in the heating technology field, which is used for communication between the heating technology components (e.g. controller, boiler, vrnetDIALOG).

### Frost protection

The frost protection function protects your heating installation and dwelling from frost damage. If the heating flow temperature falls below 5 °C when the on/off switch is on, the boiler comes into operation and heats the circulating water to 30 °C.

### Heating flow temperature

Your boiler heats water which is pumped through your heating installation. The temperature of this hot water as it leaves the boiler is referred to as the heating flow temperature.

### Hot water generation

Your boiler heats the water in the domestic hot water cylinder to the selected target temperature. If the temperature in the DHW cylinder falls by a specific amount, the water is heated up again to the target temperature.

### Legionella

Legionella are water-borne bacteria which can quickly propagate and cause serious lung diseases. Legionella bacteria occur wherever heated water provides the optimum conditions for multiplication. Temporarily heating the water to above 60 °C kills off legionella.

### Room thermostat

A room thermostat continuously measures the room temperature and compares it with the room temperature you have set (target room temperature). This allows the heating installation to maintain a constant set temperature in your room.

In addition, you can enter individual heating times. The target room temperature and the heating times set by you control the operation of your boiler, the power of which is adapted automatically to the respective heat demand.

### vrnetDIALOG Internet communication system

-vrnetDIALOG is a service connection to the Internet. Using vrnetDIALOG, your competent person can set the heating installation in your house from your PC. Fault diagnosis can also be carried out remotely via the integrated DIA system. -vrnetDIALOG can also forward fault messages by fax, e-mail or SMS to your competent person. This allows the competent person to prepare in advance of carrying out any work, if a repair is required, and to arrive with the right spare parts on the service date.

If necessary, your competent person can also carry out adjustments on the controller or boiler via vrnetDIALOG to save unnecessary visits.

### Weather compensator:

A weather compensator is a controller that controls the heating flow temperature of the heating installation, depending on the measured outside temperature.

With the weather compensator, you can also enter individual heating times. The outside temperatures that are measured and the heating times that are set control the operation of the burner, the output of which is adjusted automatically to the relevant heat demand.

## Index

<b>A</b>		<b>I</b>	
Air/flue gas duct .....	25	Identification plate .....	3
Air/flue gas pipe.....	20	If you smell gas .....	5
Anti-legionella function.....	14	Ignition .....	19, 22
		Intended use .....	4
		Isolator devices .....	11
<b>B</b>		<b>L</b>	
Burner anti-cycling time .....	9	Low water pressure.....	19
<b>C</b>		<b>S</b>	
CE label .....	3	Status displays .....	17
Controller.....	8, 14, 25	Summer mode .....	15, 22
Controls.....	8	Switching off	
Customer service.....	5, 24	Boiler .....	15
		Hot water generation .....	14
		Switching off the boiler.....	15
		Switching on	
		Boiler .....	11
		Frost protection function.....	16
		Power supply .....	18
		Switching on the boiler .....	11
<b>D</b>		<b>T</b>	
Decommissioning.....	24	Temperature	
Display .....	8, 11, 13, 15, 22	Hot water temperature .....	14
Disposal .....	24	Troubleshooting .....	17
<b>F</b>		<b>V</b>	
Fault .....	18, 19, 20	Vaillant customer service .....	5, 24
Fault clearance .....	19		
Fault codes .....	17		
Filling .....	12		
Filling pressure.....	12		
Filling the heating installation.....	12		
Flue gas.....	5		
Flue gas smell.....	5		
Frost			
Activating the frost protection function.....	16		
Draining the heating installation .....	16		
Protecting the heating installation against frost .....	16		
<b>H</b>			
Heating flow temperature .....	13		
Hot water			
Drawing hot water.....	7		
Setting the hot water temperature.....	14		
Hot water generation.....	7, 11, 14, 15, 25		
Hot water temperature.....	5, 7, 14		

## Brief operating instructions

For detailed information, please read the corresponding section in these installation instructions.

### 1. Switching off Heating mode (Summer mode) (→ section 4.10.2)

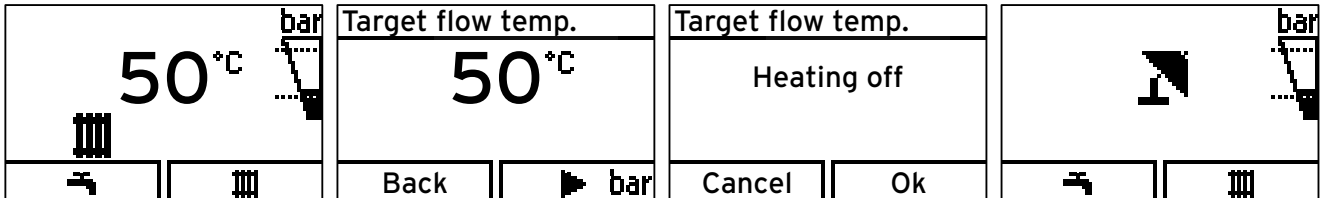

- > Right-hand selector button "III"
- > --Button to "Heating off"
- > Confirm "OK"

### 2. Setting the heating temperature (switching on Heating mode) (→ section 4.7.1)

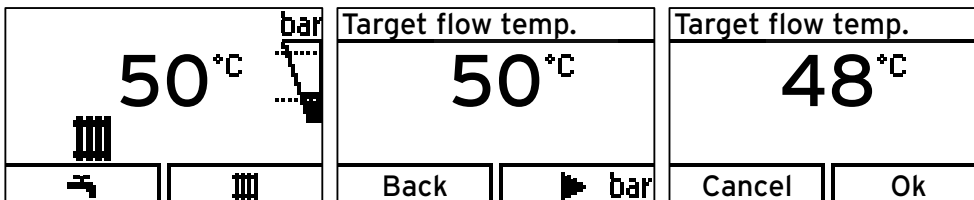

- > Right-hand selector button "III"
- > +/- button for selecting the temperature
- > Confirm "OK"

### 3. Setting the hot water temperature (→ section 4.8)

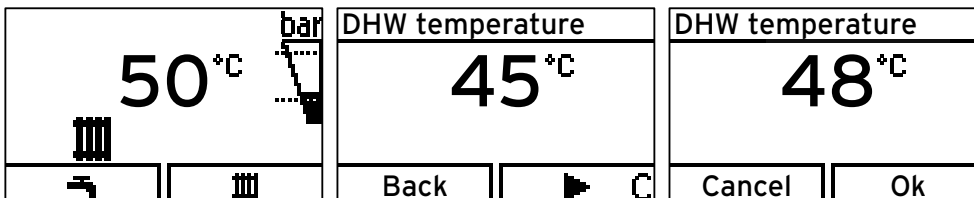

- > Left-hand selector button "I"
- > +/- button for selecting the temperature
- > Confirm "OK"

## Supplier

Vaillant Ltd

Nottingham Road ■ Belper ■ Derbyshire ■ DE56 1JT

Telephone 0845 602 2922 ■ [www.vaillant.co.uk](http://www.vaillant.co.uk) ■ [info@vaillant.co.uk](mailto:info@vaillant.co.uk)

## Manufacturer

Vaillant GmbH

Berghauser Str. 40 ■ D-42859 Remscheid ■ Telefon 0 21 91/18-0

Telefax 0 21 91/18-28 10 ■ [www.vaillant.de](http://www.vaillant.de) ■ [info@vaillant.de](mailto:info@vaillant.de)