

For the operator

Operating instructions



ecoTEC exclusive

620 (VU 206/5-7 (H-GB))

627 (VU 256/5-7 (H-GB))

835 (VUW 356/5-7 (H-GB))

843 (VUW 436/5-7 (H-GB))

GB, IE

Publisher/manufacturer

Vaillant GmbH

Berghauser Str. 40 ■ D-42859 Remscheid
Tel. +49 21 91 18-0 ■ Fax +49 21 91 18-28 10
info@vaillant.de ■ www.vaillant.de



Contents

| | | | |
|--|----------|--------------------------------------|-----------|
| Contents | B | Troubleshooting | 12 |
| | C | Status codes – Overview | 13 |
| 1 Safety | | | 3 |
| 1.1 Action-related warnings | | | 3 |
| 1.2 Intended use | | | 3 |
| 1.3 General safety information | | | 3 |
| 2 Notes on the documentation | | | 5 |
| 2.1 Observing other applicable documents | | | 5 |
| 2.2 Storing documents | | | 5 |
| 2.3 Applicability of the instructions | | | 5 |
| 3 Product description | | | 5 |
| 3.1 Product design | | | 5 |
| 3.2 Control elements | | | 5 |
| 3.3 Operator control panel | | | 5 |
| 3.4 Displayed symbols | | | 6 |
| 3.5 Information on the identification plate | | | 6 |
| 3.6 Serial number | | | 6 |
| 3.7 CE label | | | 6 |
| 3.8 Energy Saving Trust Endorsed Products | | | 6 |
| 4 Operation | | | 7 |
| 4.1 Operating concept | | | 7 |
| 4.2 Basic display | | | 7 |
| 4.3 Menu display | | | 7 |
| 4.4 Operating levels | | | 7 |
| 4.5 Cabinet-type casing | | | 7 |
| 4.6 Opening the isolator devices | | | 7 |
| 4.7 Starting up the product | | | 7 |
| 4.8 Switching on the product | | | 8 |
| 4.9 Setting the language | | | 8 |
| 4.10 Setting the hot water temperature | | | 8 |
| 4.11 Setting the heating flow temperature | | | 8 |
| 4.12 Switching Green iQ mode on and off | | | 8 |
| 4.13 Guaranteeing the correct filling pressure of the heating system | | | 9 |
| 4.14 Switching off the product's functions | | | 10 |
| 4.15 Protecting the heating installation against frost | | | 10 |
| 5 Detecting and rectifying faults | | | 10 |
| 6 Calling up (Live monitor) status codes | | | 10 |
| 7 Care and maintenance | | | 10 |
| 7.1 Maintenance | | | 10 |
| 7.2 Caring for the product | | | 10 |
| 7.3 Reading maintenance messages | | | 11 |
| 7.4 Checking the condensate drain pipework and tundish | | | 11 |
| 8 Decommissioning | | | 11 |
| 8.1 Temporarily decommissioning the product | | | 11 |
| 8.2 Permanently decommissioning the product | | | 11 |
| 9 Recycling and disposal | | | 11 |
| 10 Guarantee and customer service | | | 11 |
| 10.1 Guarantee | | | 11 |
| 10.2 Customer service | | | 11 |
| Appendix | | | 12 |
| A Operator level – overview | | | 12 |



1 Safety

1.1 Action-related warnings

Classification of action-related warnings

The action-related warnings are classified in accordance with the severity of the possible danger using the following warning signs and signal words:

Warning symbols and signal words



Danger!

Imminent danger to life or risk of severe personal injury



Danger!

Risk of death from electric shock



Warning.

Risk of minor personal injury



Caution.

Risk of material or environmental damage

1.2 Intended use

There is a risk of injury or death to the user or others, or of damage to the product and other property in the event of improper use or use for which it is not intended.

The product is intended as a heat generator for closed heating installations and for hot water generation.

Intended use includes the following:

- observance of the operating instructions included for the product and any other system components
- compliance with all inspection and maintenance conditions listed in the instructions.

This product can be used by children aged from 8 years and above and persons with reduced physical, sensory or mental capabilities or lack of experience and knowledge if they have been given supervision or instruction concerning use of the product in a safe way and understand the hazards involved. Children must not play with the product. Cleaning and user maintenance work must not be carried out by children unless they are supervised.

Any other use that is not specified in these instructions, or use beyond that specified in

this document shall be considered improper use. Any direct commercial or industrial use is also deemed to be improper.

Caution.

Improper use of any kind is prohibited.

1.3 General safety information

1.3.1 Installation by competent persons only

The installation, inspection, maintenance and repair of the product, as well as the gas ratio settings, must only be carried out by a competent person.

1.3.2 Danger caused by improper operation

Improper operation may present a danger to you and others, and cause material damage.

- ▶ Carefully read the enclosed instructions and all other applicable documents, particularly the "Safety" section and the warnings.

1.3.3 Risk of death from escaping gas

What to do if you smell gas in the building:

- ▶ Avoid rooms that smell of gas.
- ▶ If possible, open doors and windows fully and ensure adequate ventilation.
- ▶ Do not use naked flames (e.g. lighters, matches).
- ▶ Do not smoke.
- ▶ Do not use any electrical switches, mains plugs, doorbells, telephones or other communication systems in the building.
- ▶ If it is safe to do so, close the emergency control valve or the main isolator.
- ▶ If possible, close the gas isolator cock on the product.
- ▶ Warn other occupants in the building by yelling or banging on doors or walls.
- ▶ Leave the building immediately and ensure that others do not enter the building.
- ▶ Notify the gas supply company or National Grid Transco +44 (0) 800 111999 by telephone from outside of the building.

1 Safety



1.3.4 Risk of death due to a blocked or leaking flue gas pipe

What to do if you smell flue gas in the property:

- ▶ Open all accessible doors and windows fully to provide ventilation.
- ▶ Switch off the product.
- ▶ Inform a competent person.

1.3.5 Risk of death from escaping flue gas

If you operate the product with an empty condensate siphon, flue gas may escape into the room air.

- ▶ In order to operate the product, ensure that the condensate siphon is always full.

1.3.6 Risk of death due to explosive and flammable materials

- ▶ Do not use or store explosive or flammable materials (e.g. petrol, paper, paint) in the installation room of the product.

1.3.7 Risk of death due to changes to the product or the product environment

- ▶ Never remove, bridge or block the safety devices.
- ▶ Do not alter the safety devices in any way.
- ▶ Do not damage or remove any seals on components.
- ▶ Do not make any changes:
 - The product itself
 - to the gas, air, water and electricity supplies
 - to the entire flue gas installation
 - to the entire condensate drain system
 - to the expansion relief valve
 - to the drain lines
 - to constructional conditions that may affect the operational reliability of the product

1.3.8 Risk of poisoning caused by insufficient supply of combustion air

Conditions: Open-flued operation

- ▶ Ensure that there is a sufficient supply of combustion air.

1.3.9 Risk of corrosion damage due to unsuitable combustion and room air

Sprays, solvents, chlorinated cleaning agents, paint, adhesives, ammonia compounds, dust or similar substances may lead to corrosion on the product and in the air/flue pipe.

- ▶ Ensure that the supply of combustion air is always free of fluorine, chlorine, sulphur, dust, etc.
- ▶ Ensure that no chemical substances are stored at the installation site.

1.3.10 Risk of material damage caused by frost

- ▶ Ensure that the heating installation always remains in operation during freezing conditions and that all rooms are sufficiently heated.
- ▶ If you cannot ensure the operation, have a competent person drain the heating installation.

1.3.11 Risk of injury and material damage due to maintenance and repairs carried out incorrectly or not carried out at all

- ▶ Never attempt to carry out maintenance work or repairs on your product yourself.
- ▶ Faults and damage should be immediately rectified by a competent person.
- ▶ Adhere to the maintenance intervals specified.



2 Notes on the documentation

2.1 Observing other applicable documents

- ▶ You must observe all operating instructions enclosed with the system components.

2.2 Storing documents

- ▶ Keep this manual and all other applicable documents safe for future use.

2.3 Applicability of the instructions

These instructions apply only to:

Product article number

| | Article number | Gas Council Number |
|--|----------------|--------------------|
| 620 (VU 206/5-7 (H-GB)) ecoTEC exclusive | 0010017062 | 41-694-01 |
| 627 (VU 256/5-7 (H-GB)) ecoTEC exclusive | 0010017063 | 41-694-02 |
| 835 (VUW 356/5-7 (H-GB)) ecoTEC exclusive | 0010017064 | 47-044-66 |
| 843 (VUW 436/5-7 (H-GB)) ecoTEC exclusive | 0010017065 | 47-044-67 |

3 Product description

3.1 Product design

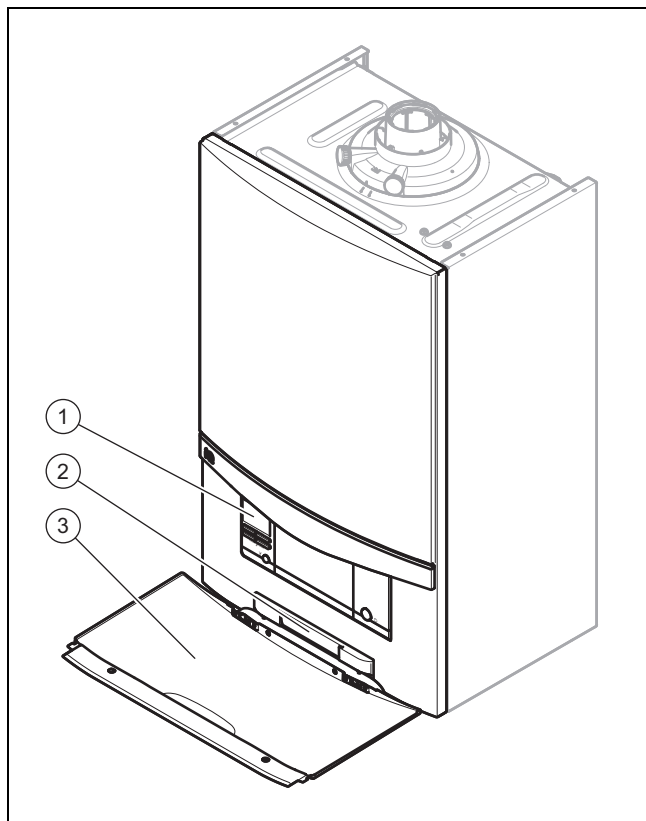

- 1 Control elements
- 2 Plate with serial number on the rear
- 3 Front flap

3.2 Control elements

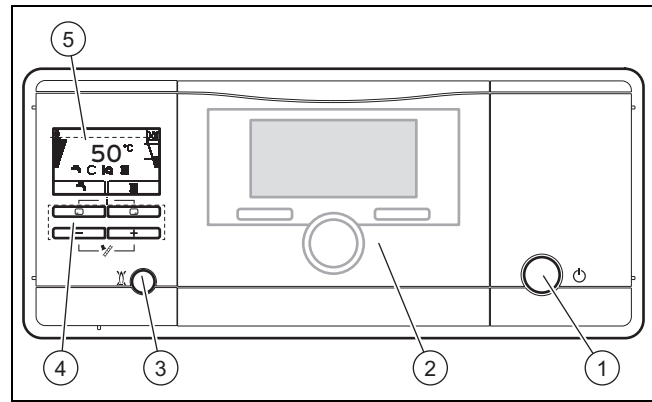

- 1 On/off button
- 2 Built-in controller (accessory)
- 3 Fault clearance button
- 4 Operating buttons
- 5 Display

3.3 Operator control panel

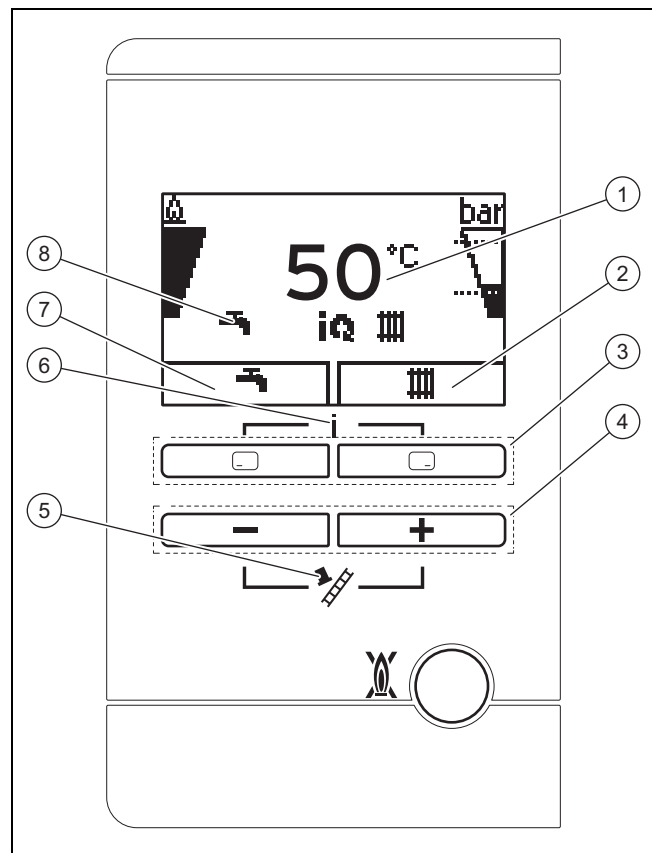

- 1 Current heating flow temperature, filling pressure of the heating installation, operating mode, fault code or additional information
- 2 Current assignment of the right-hand selection button
- 3 Left- and right-hand selection buttons
- 4 - and + button
- 5 Maximum output operation (for chimney sweeps only)
- 6 Access to the menu for additional information
- 7 Current assignment of the left-hand selection button
- 8 Active operating status

The display lights up











- if you switch on the product or

3 Product description

- if you press a button while the product is switched on. At first, pressing this button does not trigger any other function.

The light goes out after one minute if you do not press any button.



3.4 Displayed symbols

| Symbol | Meaning | Explanation |
|---|--|---|
|  | Burner operating correctly | Burner on |
|  | Current burner modulation rate | |
|  | Current filling pressure of the heating system The dashed lines show the permitted range. | <ul style="list-style-type: none"> - Permanently on: Filling pressure in the permitted range. - Flashing: Filling pressure outside the permitted range. |
|  | Hot water generation active | <ul style="list-style-type: none"> - Permanently on: Draw-off mode before burner is on - Flashing: Burner on in draw-off mode |
|  | Heating mode active | <ul style="list-style-type: none"> - Permanently on: Heating mode heat requirement - Flashing: Burner on in heating mode |
|  | Green iQ mode active | - Permanently on: Energy-saving mode active |
|  | Maintenance required | Information on maintenance message in the "Live Monitor". |
|  | Summer mode active Heating mode is switched off | |
|  | Burner anti-cycling time is active | To avoid the need for frequent switching on and off (increases the product's working life). |
|  F.XX | Fault in the product | Appears instead of the basic display, may be an explanatory plain text display. |

3.5 Information on the identification plate

The identification plate is mounted on the underside of the product in the factory.

| Information on the identification plate | Meaning |
|---|---|
|  | Read the instructions. |
| VU(W) ... | Type designation |
| ..6/5-7 | Calorific value power/product generation equipment |
| ecoTEC exclusive | Product description |
| 2H, G20 – 20 mbar (2.0 kPa) | Gas group and gas connection pressure as set at the factory |
| ww/yyyy | Date of manufacture: Week/year |

| Information on the identification plate | Meaning |
|--|---|
| Cat. | Approved unit categories |
| Types | Approved gas-fired units |
| PMS | Permissible total overpressure in heating mode |
| PMW | Permissible total overpressure during hot water generation |
| T _{max.} | Max. flow temperature |
| ED 92/42 | Current efficiency directive fulfilled with 4* rating |
| V Hz | Mains voltage and mains frequency |
| W | Max. electrical power consumption |
| IP | Level of protection |
|  | Heating mode |
|  | Hot water generation |
| P | Nominal heat output range |
| Q | Heat input range |
| D | Nominal hot water draw-off rate |
|  | Bar code with serial number, 7th to 16th digit = product article number |

3.6 Serial number

The serial number is located on a plate behind the front flap. The plate is in a plastic fish plate. You can also display the serial number in the display.

3.7 CE label



The CE label shows that the products comply with the basic requirements of the applicable directives as stated on the identification plate.

The declaration of conformity can be viewed at the manufacturer's site.

3.8 Energy Saving Trust Endorsed Products



Only the most energy efficient products can carry the 'Energy Saving Trust Endorsed Product' landmark making it easy for consumers to choose products that have met strict energy performance criteria.

Available for: Boilers, Heating controls and chemical inhibitors, the Energy Saving Trust endorsed product landmark gives consumers confidence that a product will cost less to run, help lower energy bills and reduce carbon emissions.

About the Energy Saving Trust

Energy Saving Trust is an independent and impartial organisation that provides trusted energy saving advice to empower millions of people to lead affordable, low energy lifestyles. For more information visit energysavingtrust.org.uk

4 Operation

4.1 Operating concept

| Operator control element | Function |
|--------------------------|---|
| | <ul style="list-style-type: none"> Setting the hot water temperature Cancelling the activation of an operating mode Cancelling a change to a set value Going one selection level higher |
| | <ul style="list-style-type: none"> Setting the heating flow temperature Reading the system pressure Activating the comfort mode Activating the operating mode Confirm setting Going one selection level lower |
| + at the same time | <ul style="list-style-type: none"> Calling up the menu |
| or | <ul style="list-style-type: none"> Reducing or increasing the set value Scrolling through menu entries |

The current function of the and buttons is shown in the display.

Adjustable values are always displayed as flashing.

You must always confirm a change to a value. Only then is the new setting saved. You can press to cancel a procedure.

4.2 Basic display

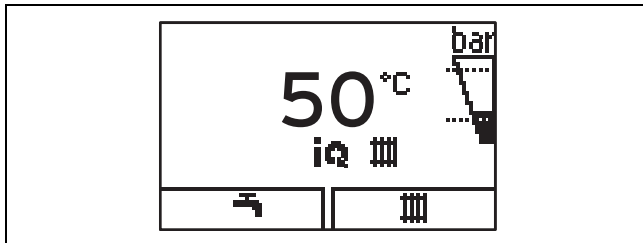

The basic display shows the current condition of the product. If you press a selection button, the activated function is displayed in the display.

The functions that are available depend on whether a controller is connected to the product.

You can switch back to the basic display by:

- Pressing to exit the selection levels
- Not pressing any button for longer than 15 minutes.

If there is an error message present, the basic display switches to the error message.

4.3 Menu display

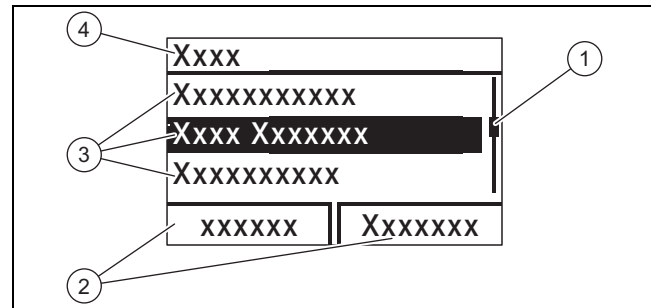

- | | | | |
|---|--|---|------------------------------|
| 1 | Scroll bar | 3 | Selection level list entries |
| 2 | Current assignment of the and buttons. | 4 | Name of the selection level |

You can find an overview of the menu structure in the appendix.

Operator level – overview (→ Page 12)

4.4 Operating levels

The product has two operating levels.

The operating level for the operator shows information and offers set-up options that do not require any special prior knowledge.

The operating level for the competent person is protected by a code.

Operator level – overview (→ Page 12)

4.5 Cabinet-type casing

Enclosing the product in cabinet-type casing requires compliance with the applicable design instructions.

If you require cabinet-type casing for your product, consult a heating specialist company. Never, under any circumstances, enclose the product yourself.

4.6 Opening the isolator devices

- Ask the competent person who installed the product to explain to you where these isolator devices are located and how to handle them.
- Open the gas isolator cock fully.
- Open the service valves in the heating installation's flow and return.

Conditions: Product with integrated hot water generation

- ▶ Open the cold water stop valve.

4.7 Starting up the product

- ▶ Only start up the product once the casing has been completely closed.

4 Operation

4.8 Switching on the product

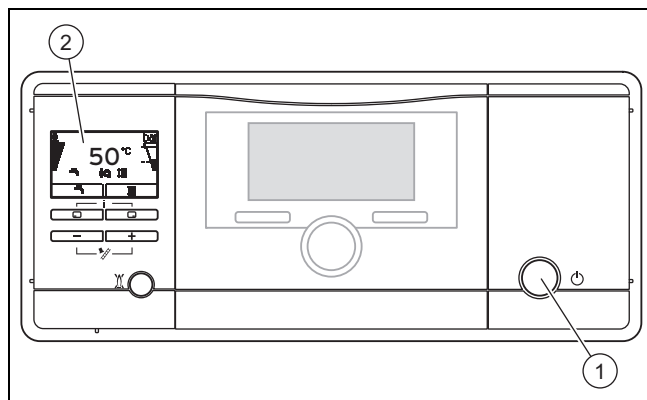

- ▶ Press the on/off button (1).
 - ◁ The "Basic display" (→ Page 7) (2) appears on the display.

4.9 Setting the language

1. Press **and hold** and **at the same time**.
2. **Also** briefly press .
3. **Press and hold** and until the display shows the language setting.
4. Select the required language by pressing or .
5. Confirm by pressing .
6. Once you have set the correct language, press again to confirm this.

4.10 Setting the hot water temperature

Conditions: Water hardness: > 3.57 mol/m³

- ▶ Have a competent person take appropriate measures to protect against Legionella.
 - ▶ Set the hot water temperature to a maximum of 50 °C.
1. Press ().
 - ◁ The set hot water temperature flashes in the display.

Conditions: No controller connected

- ▶ Change the hot water temperature by pressing or .
- ▶ Confirm by pressing .

Conditions: Controller connected

- ▶ Use to set the maximum possible hot water temperature on the product.
- ▶ Confirm by pressing .
- ▶ Set the required hot water temperature on the controller (→ Controller operating instructions).

4.11 Setting the heating flow temperature

1. Press ().
 - ◁ The target value of the heating flow temperature appears on the display.



Note

The competent person may have adjusted the maximum possible temperature.

Conditions: No controller connected

- ▶ Use or to set the required heating flow temperature.
- ▶ Confirm by pressing .

Conditions: Controller connected

- ▶ Set the maximum possible heating flow temperature on the product.
- ▶ Confirm by pressing .
- ▶ Set the required heating flow temperature on the controller (→ Controller operating instructions).

4.12 Switching Green iQ mode on and off



Note

Green iQ mode is an energy-saving operating mode. If this mode is activated, the product operates in the heating and cylinder charging mode in such a way that the maximum benefits associated with condensing technology are achieved.

1. Press and at the same time.
 - ◁ The menu is called up.
 2. Navigate to the **Green iQ** menu item and press .
 - **Menu** → **Basic settings** → **Green iQ**
 3. Press or to activate or deactivate **Green iQ** mode respectively.
 - ◁ **Mode on** or **Mode off** will flash on the display.
 4. Confirm by pressing .
- ◁ If you have activated **Green iQ** mode, the **iQ** symbol will appear on the basic display. If you have deactivated **Green iQ** mode, the **iQ** symbol will disappear from the basic display.

4.13 Guaranteeing the correct filling pressure of the heating system

4.13.1 Checking the filling pressure of the heating installation



Note

To ensure that the heating installation operates smoothly, the filling pressure when the heating installation is cold must be between 0.1 MPa and 0.2 MPa (1.0 bar and 2.0 bar) or lie between the two dashed lines in the bar graph display.

If the heating installation extends over several storeys, a higher filling pressure may be required for the heating installation. Ask a competent person for details.

In addition, the symbol appears after approx. one minute.

If the filling pressure in the heating installation falls below 0.05 MPa (0.5 bar), then the product switches off. The display alternates between the fault message **F.22** and the current filling pressure.

1. Press twice.
 - ◁ The values for the current filling pressure and for the minimum and maximum filling pressures appear in the display.
2. Check the filling pressure in the display.

1 / 2
System pressure: 0.1 ... 0.2 MPa (1.0 ... 2.0 bar)
The filling pressure is in the intended pressure range.

2 / 2
Filling pressure: < 0.08 MPa (< 0.80 bar)

 - ▶ Fill the heating installation. (→ Page 9)
 - ◁ If you have topped up the installation with sufficient heating water, the display automatically disappears after 20 seconds.

4.13.2 Filling the heating installation



Caution.

Risk of material damage due to heating water that is extremely calciferous or corrosive or contaminated by chemicals.

Unsuitable tap water damages the seals and diaphragms, blocks components in the product and heating installation through which the water flows and causes noise.

- ▶ Only fill the heating installation with suitable heating water.
- ▶ In case of doubt, ask a competent person for details.

1. Ask a competent person where the filling cock is located.
2. Open all radiator valves (thermostatic radiator valves) of the heating installation.

Conditions: Product for heating mode only

- ▶ Connect the filling cock to a hot water supply in the way you were told by the competent person.
- ▶ Open the hot water supply.
- ▶ Turn the filling cock on slowly and allow water to flow in until the required filling pressure has been reached.
- ▶ Close the hot water supply.
- ▶ Purge all radiators.
- ▶ Check the filling pressure in the display.
- ▶ Top up with more water if necessary.
- ▶ Close the hot water supply.

Conditions: Product with integrated hot water generation and filling loop

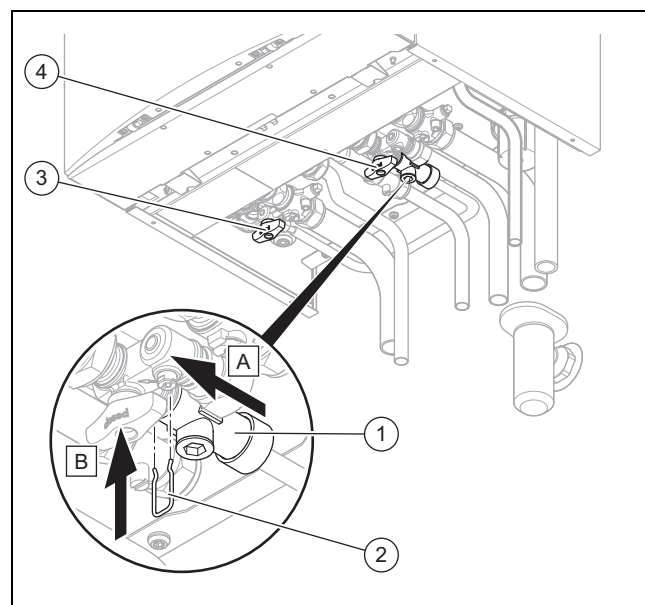

- ▶ Fit the double non-return valve (1) of the filling line to the cold water stop valve and secure the valve with the spring clip (2).
- ▶ To fill, first open the stop valve (3).
- ▶ Slowly open the stop valve (4) so that the water flows into the heating system. Fill it with water until the required filling pressure is reached.
- ▶ Close the stop valve (4).
- ▶ Purge all radiators.
- ▶ Check the filling pressure in the display.
- ▶ Top up with more water if necessary.
- ▶ After filling, close both stop valves and disconnect the filling device by removing the double non-return valve from the cold water stop valve.



Note

Both stop valves must be closed while the heating system is operating and the filling line must be removed from the double non-return valve again.





3. Return to the basic display. (→ Page 7)

5 Detecting and rectifying faults





4.14 Switching off the product's functions

4.14.1 Switching off hot water generation

Applicability: Product with hot water generation through external domestic hot water cylinder

1. To switch off cylinder charging without switching off heating mode, press  ().
 - ◁ The set hot water temperature flashes in the display.
2. Use the  button to set the hot water temperature to **Cylinder charging off**.
3. Confirm by pressing .
 - ◁ Cylinder charging is switched off.
 - ◁ Only the frost protection function for the cylinder remains active.

4.14.2 Switching off heating mode (Summer mode)

1. To switch off heating mode without switching off hot water generation, press  ().
 - ◁ The value of the heating flow temperature appears in the display.
2. Use the  button to set the heating flow temperature to **Heating off**.
3. Confirm by pressing .
 - ◁ Heating mode is switched off
 - ◁ The  symbol appears in the display.

4.15 Protecting the heating installation against frost

4.15.1 Frost protection function



Caution.

Risk of material damage due to frost.

The frost protection function cannot guarantee flow through the entire heating installation, which means that parts of the heating installation may freeze and therefore become damaged.

- ▶ During a period of frost, ensure that the heating installation remains in operation and that all rooms are sufficiently heated, even when you are away.



Note

To keep the frost protection devices active, you should switch your product on and off using the controller, if one is provided.

If the heating flow temperature falls below 5 °C when the on/off button is on, the product comes into operation and heats the circulating water to approx. 30 °C on both the heating side and the hot water side (if available).

4.15.2 Draining the heating installation



Another way to protect the heating installation and the product from frost for very long switch-off times is to drain them completely.

- ▶ Consult a competent person about this.

5 Detecting and rectifying faults

- ▶ If faults occur, proceed in accordance with the table in the appendix.
Troubleshooting (→ Page 12)
- ▶ If you are unable to eliminate the faults using the specified measures, if fault messages (F.xx) are displayed, or if the product does not function correctly, contact a competent person.

6 Calling up (Live monitor) status codes

1. Press  and  at the same time.
 - ◁ The menu is called up.
2. Navigate to **Menu** → **Live monitor** and confirm by pressing .
Status codes – Overview (→ Page 13)

7 Care and maintenance

7.1 Maintenance

An annual inspection of the product carried out by a competent person is a prerequisite for ensuring that the product is permanently ready and safe for operation, reliable, and has a long working life.

7.2 Caring for the product



Caution.

Risk of material damage caused by unsuitable cleaning agents.

- ▶ Do not use sprays, scouring agents, detergents, solvents or cleaning agents that contain chlorine.
-
- ▶ Clean the casing with a damp cloth and a little solvent-free soap.

7.3 Reading maintenance messages

If the  symbol is shown in the display, the product requires maintenance work. The product is not in fault mode; it continues to operate.

- ▶ Consult a competent person.
- ▶ If the water pressure is flashing at the same time, simply add more heating water.

7.4 Checking the condensate drain pipework and tundish

The condensate drain pipework and tundish must always be penetrable.

- ▶ Regularly check the condensate drain pipework and tundish for faults and, particularly, for blockages.

You must not be able to see or feel any obstructions in the condensate drain pipework and tundish.

- ▶ If you notice a fault, have it rectified by a competent person.

8 Decommissioning

8.1 Temporarily decommissioning the product



Caution.

Risk of material damage due to frost.

The frost protection and monitoring devices are only active while the product is connected to the power mains and switched on via the on/off button, and when the gas isolator cock is open.

- ▶ Temporarily decommission the product only if no frost is expected.

1. Switch off the product using the on/off button.
 - ◀ The display goes out.
2. When decommissioning the product for an extended period (e.g. holiday), also close the gas isolator cock.

8.2 Permanently decommissioning the product

- ▶ Have a competent person permanently decommission the product.

9 Recycling and disposal

- ▶ The competent person who installed your product is responsible for the disposal of the packaging.



If the product is identified with this symbol:

- ▶ In this case, do not dispose of the product with the household waste.
- ▶ Instead, hand in the product to a collection centre for old electrical or electronic appliances.



If the product contains batteries that are marked with this symbol, these batteries may contain substances that are hazardous to human health and the environment.

- ▶ In this case, dispose of the batteries at a collection point for batteries.

10 Guarantee and customer service

10.1 Guarantee

- Two year guarantee

Vaillant provides this appliance with a parts and labour guarantee against defects that may occur within twenty-four months of the installation date. For the 2nd year of the guarantee to be valid an annual service must be carried out by a competent person approved at the time by the Health and Safety Executive one year after installation. The cost of this annual service is not included in the guarantee.

- Registering with us

Registration is simple. Just complete the Guarantee Registration Card and return to Vaillant within 30 days of installation. Your details will then be automatically registered within the Vaillant scheme.

- Immediate help

If your Vaillant boiler develops a fault your first action should be to contact your installer, as his professional assessment is needed under the terms of our Guarantee. If you are unable to contact your installer, phone Vaillant Service Solutions:

Telephone: 0330 100 3461

10.2 Customer service

To ensure regular servicing, it is strongly recommended that arrangements are made for a Maintenance Agreement. Please contact Vaillant Service Solutions for further details:

Telephone: 0330 100 3461

Appendix

Appendix

A Operator level – overview

| Setting level | Values | | Unit | Increment, select | Default setting |
|-------------------------|------------------|------|------|-----------------------------------|------------------|
| | Min. | Max. | | | |
| Water pressure → | | | | | |
| Water pressure | Current value | | bar | | |
| Live monitor → | | | | | |
| Status | Current value | | | | |
| Information → | | | | | |
| Contact details | Phone number | | | | |
| Serial number | Permanent value | | | | |
| Display contrast | Current value | | | 1 | 25 |
| | 15 | 40 | | | |
| comDIALOG | Current value | | | No function | |
| Basic settings → | | | | | |
| Language | Current language | | | Languages available for selection | Country-specific |
| Green iQ | Current value | | | On, Off | On |
| Display contrast | Current value | | | 1 | 25 |
| | 15 | 40 | | | |
| Resets → | | | | | |
| Reset anti-cycl. time | Current value | | min | | |

B Troubleshooting

| Fault | Cause | Measure |
|--|---|--|
| Product does not start up: – No hot water – Heating remains cold | The gas isolator cock installed on-site and/or the gas isolator cock on the product is closed. | Open both gas isolator cocks. |
| | The cold water stop valve is closed. | Open the cold water stop valve. |
| | The power supply in the building is disconnected. | Check the fuse in the building. The product switches on automatically when the power is restored. |
| | The product is switched off. | Switch on the product (→ "Switching on the product" section). |
| | The heating flow temperature is set too low or to the Heating off position, and/or the hot water temperature is set too low. | Set the heating flow temperature and hot water temperature (→ "Setting the heating flow temperature" section/→ "Setting the hot water temperature" section). |
| | The system pressure is insufficient. Low water pressure in the heating installation (fault message: F.22). | Fill the heating installation (→ "Filling the heating installation" section). |
| | There is air in the heating installation. | Have your competent person purge the heating installation. |
| | After three unsuccessful attempts to ignite the flame, the product switches to fault mode (fault message: F.28). | Press the fault clearance key for one second. The product makes another attempt to ignite the flame. If you have been unable to eliminate the ignition fault after three fault clearance attempts, consult a competent person. |

| Fault | Cause | Measure |
|--|---|--|
| Product does not start up: – No hot water – Heating remains cold | There is a fault in the flue gas route (fault message: F.36/F.37): – The symbols XXXXX are shown in the display. – The red LED is lit continuously. | Have your competent person rectify the fault. |
| Hot water generation functioning correctly; heating does not start up. | The external controller is not set correctly. | Set the external controller correctly (→ Controller operating instructions). |

C Status codes – Overview

Status codes that are not listed here can be viewed in the installation instructions.

| Status code | Meaning |
|--|---|
| Displays in heating mode | |
| S.00 | Heating: No heat demand |
| S.01 | Heating mode: Fan start-up |
| S.02 | Heating mode: Pump pre-run |
| S.03 | Heating mode: Ignition |
| S.04 | Heating mode: Burner on |
| S.05 | Ventilator and pump overrun |
| S.06 | Heating mode: Fan overrun |
| S.07 | Heating mode: Pump overrun |
| S.08 | Heating, remaining anti-cycling time xx mins |
| S.09 | Heating mode: Measuring program |
| Displays in Comfort mode with warm start or hot water handling mode with cylinder | |
| S.20 | Hot water requirement |
| S.21 | DHW mode: Fan start-up |
| S.22 | DHW mode: Pump pre-run |
| S.23 | DHW mode: Ignition |
| S.24 | DHW mode: Burner on |
| S.25 | DHW mode: Pump/fan overrun |
| S.26 | DHW mode: Fan overrun |
| S.27 | DHW mode: Pump overrun |
| S.28 | Hot water burner anti-cycling time |
| S.29 | DHW mode: Measuring program |
| Other displays | |
| S.30 | Room thermostat (RT) is blocking heating mode |
| S.31 | Summer mode active |
| S.34 | Frost protection mode, frost protection |
| S.37 | Waiting time: Deviation in fan speed |
| S.40 | Comfort protection active |
| S.57 | Waiting time: Measuring program |
| S.58 | Modulation limitation due to noise/wind |
| S.76 | System pressure too low. Top up water. |



0020193967_00 ■ 14.12.2015

Vaillant Ltd.

Nottingham Road ■ Belper ■ Derbyshire ■ DE56 1JT

Telephone 0330 100 3461

info@vaillant.co.uk ■ www.vaillant.co.uk

© These instructions, or parts thereof, are protected by copyright and may be reproduced or distributed only with the manufacturer's written consent.