

For the operator

Operating instructions



ecoTEC plus

Gas-fired wall hung high efficiency boiler

GB, IE

Table of Contents

Table of Contents

1	Notes on the documentation	3	5.8	Protecting the heating system against frost	19
1.1	Storing documents	3	5.8.1	Activating the frost protection function	19
1.2	Symbols used	3	5.8.2	Draining the heating system	19
1.3	Applicability of the instructions	3			
1.4	Identification plate	3			
1.5	CE label	3			
2	Safety	5	6	Energy saving tips	20
2.1	Safety and warning information	5	7	Troubleshooting	22
2.1.1	Classification of warnings	5	7.1	Reading fault messages	22
2.1.2	Structure of warnings	5	7.2	Detecting and rectifying malfunctions	23
2.2	Intended use	5	7.3	Rectifying a water shortage	23
2.3	Basic safety instructions	6	7.4	Resolving ignition faults	24
			7.5	Maintenance message	24
3	Description of devices and functions	8	8	Additional functions	25
3.1	Design	8	8.1	Operation in the menu	25
3.2	Function	8	8.1.1	Structure of the menu	25
3.2.1	Heating mode	8	8.1.2	Overview of menu structure	26
3.2.2	Hot water production with domestic hot water cylinder (VU boiler)	8	8.2	Displaying Live monitor (current status of the boiler)	27
3.2.3	Hot water production with VUW boiler	8	8.3	Setting the display contrast	27
3.2.4	Hot water production with VUI boiler/VUW boiler with actoSTOR	9	8.4	Setting the language	27
			8.5	Displaying contact data for the competent person	28
4	Operation	10	8.6	Displaying the serial number and article number	28
4.1	Overview of the control elements	10	8.7	Reset burner off time (resetting burner anti-cycling time)	28
4.2	Digital Information and Analysis System (DIA)	10	9	Service	29
4.3	Operating concept	11	9.1	Servicing the boiler	29
4.4	Basic display	12	9.2	Caring for your boiler	29
4.5	Operating levels	12	10	Decommissioning	30
5	Operation	13	10.1	Disposing of the boiler	30
5.1	Putting the boiler into service	13	10.2	Disposing of the packaging	30
5.1.1	Opening/closing the isolator devices	13	11	Manufacturer's guarantee and works customer services	31
5.1.2	Switching on the boiler	13	11.1	Factory guarantee	31
5.1.3	Checking the fill level of the heating system	14	11.2	Vaillant Service	31
5.1.4	Filling the heating system	14	12	Glossary	32
5.2	Setting the heating flow temperature	15	Index		33
5.2.1	Setting the heating flow temperature without a controller connected	15	Brief operating instructions		35
5.2.2	Using a controller to set the heating flow temperature	15			
5.3	Hot water production with VUW boilers	15			
5.3.1	Setting the hot water temperature	16			
5.3.2	Activating/deactivating Comfort mode	16			
5.3.3	Setting the cylinder charging mode (VUI 937 only)	16			
5.4	Hot water production with VU boilers	17			
5.5	Setting a room thermostat or weather compensator	18			
5.6	Switching off the functions of the boiler	18			
5.6.1	Switching off hot water production (VU boiler)	18			
5.6.2	Switching off Heating mode (summer mode)	18			
5.7	Temporarily shutting down the boiler	19			

1 Notes on the documentation

The following instructions are intended to guide you throughout the entire documentation. Other documents apply in addition to these operating instructions. We accept no liability for any damage caused by failure to observe these manuals.

Other applicable documents

When operating the ecoTEC plus, you must observe all operating instructions that are included with other components of your system.

Further instructions for all accessories and controllers used also apply.

The benchmark check list for starting up gas-fired boilers (contained in the installation instructions) must be completed by the competent person present during the commissioning and must be passed on to the system operator. After reading through these instructions, if you have any questions regarding the operation of the boiler, please contact your recognised approved heating specialist company or Vaillant's technical department.

In these instructions, the heating specialist company and competent person approved by the Health and Safety Executive will be abbreviated as the heating specialist company and competent person.

1.1 Storing documents

- Store these operating instructions and all other applicable documents in such a way that they are available whenever required.
- If you move out or sell the house, pass on the documents to the next occupant as well.

1.2 Symbols used

The symbols used in the text are explained below: Symbols for identifying dangers are also used in these operating instructions (→ **Section 2.1.1**).



Symbol that denotes useful tips and information

- Symbol for a required action

1.3 Applicability of the instructions

These operating instructions apply exclusively to appliances with the following article numbers:

Boiler	Type designation	Article number
ecoTEC plus	VU GB 612/5-5	0010011677
ecoTEC plus	VU GB 615/5-5	0010011678
ecoTEC plus	VU GB 618/5-5	0010011679
ecoTEC plus	VU GB 618/5-5 (LPG)	0010011680
ecoTEC plus	VU GB 624/5-5	0010011681
ecoTEC plus	VU GB 630/5-5	0010011682
ecoTEC plus	VU GB 630/5-5 (LPG)	0010011683
ecoTEC plus	VU GB 637/5-5	0010011684
ecoTEC plus	VUW GB 824/5-5	0010011685
ecoTEC plus	VUW GB 831/5-5	0010011686
ecoTEC plus	VUW GB 831/5-5 (LPG)	0010011687
ecoTEC plus	VUW GB 837/5-5	0010011688
ecoTEC plus	VUI GB 937/5-5	0010011691

1.1 Type overview

To find out the article number of your boiler, refer to the identification plate.

1.4 Identification plate

The identification plate of your Vaillant ecoTEC plus boiler is attached at the factory to the underside of your boiler. The seventh to sixteenth digits of the serial number on the identification plate represent the article number. The serial numbers are also located on a plate, which is stuck behind the front flap on the underside of the boiler in a plastic fish plate (→ **Fig. 3.1 Item 2**). You can also view the serial number in the display of the boiler (→ **Section 8.6**).

1.5 CE label



The CE label shows that the boilers comply with the basic requirements of the applicable directives as stated on the identification plate.

1 Notes on the documentation



Vaillant Ltd. supports the Benchmark Initiative. A benchmark check-list for commissioning gas-fired boilers is attached to these installation instructions. It is very important that this document be filled out properly when installing, commissioning and handing-over to the system operator.







2 Safety

2.1 Safety and warning information

- When operating your boiler, take account of the general safety instructions and the warning notes that appear before each action.

2.1.1 Classification of warnings

The warnings are classified in accordance with the severity of the possible danger using the following warning signs and signal words:

Warning sign	Signal word	Explanation
	Danger!	Immediate danger to life or risk of severe personal injury
	Danger!	Risk of death from electric shock
	Warning!	Risk of minor personal injury
	Caution!	Risk of material or environmental damage

2.1 Meaning of warning signs and signal words

2.1.2 Structure of warnings

Warnings are identified by an upper and lower separating line and are laid out according to the following basic principle:



Signal word!

Type and source of danger!

Explanation of the type and source of danger

- Measures for averting the danger

2.2 Intended use

The Vaillant ecoTEC plus boilers are state-of-the-art appliances which have been constructed in accordance with recognised safety regulations. Nevertheless, there is still a risk of injury or death to the operator or others or of damage to the boiler and other property in the event of improper use or use for which it is not intended.

This boiler is not intended for use by persons (including children) having limited physical, sensory or mental capacities or who have inadequate experience and/or knowledge, unless supervised by a person responsible for their safety or who has been given instructions from them as to how to operate the boiler.

Children must be supervised to ensure that they do not play with the boiler.

The boiler is intended as a heater for closed hot water/central heating systems and for hot water generation.

The use of the ecoTEC plus in vehicles, such as mobile homes and caravans, is not classed as intended use. Units that are not classed as vehicles are those that are installed in a fixed and permanent location and that do not have any wheels (fixed installation).

Any other use, or use beyond that specified, shall be considered as improper use. Any direct commercial or industrial use is also deemed to be improper.

The manufacturer or supplier is not liable for any damage resulting from such use. The user alone bears the risk.

Intended use includes the following:

- observing the included operating, installation and maintenance instructions for the Vaillant product and any other parts and components of the system
- installing and fitting the appliance in accordance with the boiler and system approval
- complying with all of the inspection and maintenance conditions listed in the instructions.

Caution!

Any misuse is forbidden.



2 Safety



2.3 Basic safety instructions

- Observe the following safety instructions at all times.

Installation and settings

The boiler must only be installed by a suitably qualified competent person. The existing regulations, rules and guidelines must be observed when doing so. He is also responsible for inspection, maintenance and repairs to the boiler, and alterations to the gas volume setting.

What to do if you smell gas in buildings

Installation errors, damage, handling, an unauthorised installation site or similar can cause gas to escape and result in a risk of poisoning and explosion. If there is a smell of gas in the building, proceed as follows:

- Avoid rooms that smell of gas.
- If possible, open doors and windows fully and ensure adequate ventilation.
- Avoid the use of naked flames (e.g. lighters, matches).
- Do not smoke.
- Do not use any electrical switches, mains plugs, doorbells, telephones or other intercommunication systems in the building.
- Close the gas meter isolator device or the main isolator device.
- If possible, close the gas isolator cock on the boiler (→ **Section 5.1.1**).
- Warn other occupants in the building by calling out or banging on doors or walls.
- Leave the building.
- If you can actually hear gas leaking, leave the building immediately and ensure that others do not enter the building.
- Alert the police and fire brigade once you are outside the building.
- Use a telephone outside the building to inform the emergency service department of the gas supply company.

National phone number for gas emergencies:
0800 111 999

What to do in an emergency if you smell flue gas

Installation errors, damage, handling, an unauthorised installation site or similar can cause flue gas to escape and result in a risk of poisoning. If there is a smell of flue gas in the building, proceed as follows:

- Open all accessible doors and windows fully and ensure adequate ventilation.
- Switch the boiler OFF.
- Inform a heating specialist company.

Explosives and highly flammable substances

The risk of explosion arises from the flammable mixture of gas and air. Take note of the following:

- Do not use or store explosive or highly flammable substances (e.g. petrol, paper, paint) in the same room as the boiler.

Preventing scalding

There is a danger of scalding at the hot water draw-off points if the hot water temperatures are greater than 60 °C. Young children and elderly persons are particularly at risk, even at lower temperatures.

- Select the temperature so that nobody is at risk.

Preventing material damage due to unauthorised changes to the appliance.

Take note of the following:

- Never interfere or tamper with the boiler or other parts of the heating system.
- Never try to carry out maintenance work or repairs on the boiler yourself.
- Do not damage or remove any seals on components.

Only recognised heating specialist companies are authorised to alter sealed components.

Material damage caused by corrosion

To prevent corrosion on the boiler and also on the flue system, note the following:

- Do not use sprays, solvents, chlorinated cleaning agents, paint, adhesives or similar substances in the vicinity of the boiler.

These substances can cause corrosion, even in the flue system.

Preventing frost damage

If there is a power cut, or if the room temperature is set too low in individual rooms, it cannot be ruled out that sections of the heating system might be damaged by frost.

- If you are going to be away during a cold period, make sure the heating system remains in operation and that the rooms are sufficiently heated.
- Always observe the information on frost protection provided in → **Section 5.8**.

Even if rooms, or the whole dwelling, are not in use for certain periods, the heating must remain in operation.

Caution!

Frost protection and monitoring devices are only active while the boiler is connected up to the power supply. The boiler must be connected to the power supply. The boiler must be switched on. You can see from symbols and/or text in the display that the boiler is switched on.



Caution!

- Under no circumstances should you add frost protection agents (or other additives, e.g. jointing compounds, corrosion protection agents, etc.) to the heating water without first consulting your qualified competent person. Otherwise, this could result in damage to seals and diaphragms as well as noises during heating operation. Vaillant assumes no liability for this or any consequential damage.

Another way to protect the heating system and the boiler from frost is to drain them. In doing so, you must ensure that the heating system and boiler are completely drained.

- Contact your approved heating specialist company for advice.

Keeping the boiler ready for operation with an emergency power generator in the event of a power cut

Your recognised heating specialist company connected your boiler to the power mains during installation.

If the power supply is cut, it is possible that parts of the heating system may become damaged by frost.

If you want to maintain the operation of the boiler during a power cut using an emergency power generator, take note of the following:

- Make sure that the technical values of this generator (frequency, voltage, earthing) match those of the power mains.
- Contact your approved heating specialist company for advice.

Changes to the surroundings of the boiler

You must not make any changes to the surroundings of the boiler:

- Never shut down the safety devices.
- Do not tamper with any of the safety devices.
- Do not make any changes:
 - to the boiler
 - to the gas, air, water and electricity supply lines,
 - to the entire flue system,
 - to the entire condensate drain system,
 - to the expansion relief valve or the drain line and
 - to constructional conditions that could affect the operational reliability of the boiler.

Cupboard Installation

- If you require your boiler to be fitted into a kitchen type cupboard then please consult your approved heating specialist company. Under no circumstances must you enclose your boiler yourself.

Enclosing the boiler in a cupboard requires compliance with the special design instructions. This is to ensure all necessary access is available for all necessary future service requirements.

What to do if there are leaks in the hot water pipes

Take note of the following:

- In the event of leaks, immediately close the cold water stop valve in the hot water pipework between the boiler and the draw-off points.
- Have the leak repaired by your approved heating specialist company.

With Vaillant ecoTEC plus boilers, the cold water stop valve is not included in the scope of delivery of your boiler.

- Ask your approved heating specialist company where they fitted the cold water stop valve.

Preventing damage caused by low system pressure in the heating system

To prevent the heating system being used when the amount of water is too low and to therefore prevent any subsequent damage that may be caused by this, note the following:

- Check the filling pressure of the heating system at regular intervals.
- Always observe the information on filling pressure provided in → **Section 5.1.3.**

Requirements for the installation site

It is not necessary to keep a clearance between the boiler and combustible materials or components since, at the nominal heat output of your boiler, the temperature on the surface of the casing is always lower than the maximum permissible temperature of 85°C.

3 Description of devices and functions

3 Description of devices and functions

3.1 Design

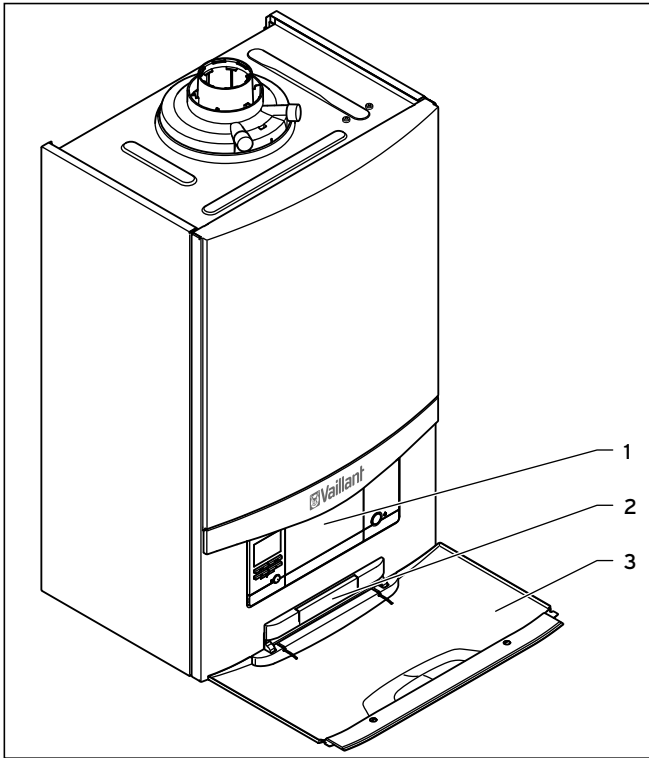

3.1 Front view of the ecoTEC plus (VU and VUW boiler)

Key

- 1 Controls
- 2 Plate with serial number on the rear
- 3 Front flap

The controls for your boiler are arranged behind the front flap.

To access the controls, open the front flap as follows:

- Reach into the recessed grip in the front flap.
- Fold down the front flap.

3.2 Function

Your Vaillant ecoTEC plus is a gas-fired wall hung high efficiency boiler, which generates heat for heating and/or hot water production.

VU boilers can be operated together with a domestic hot water cylinder, which stores a larger volume of hot water. VUI boilers are fitted with internal hot water production and a domestic hot water cylinder to achieve increased hot water convenience.

3.2.1 Heating mode

In heating mode, the boiler heats the hot water and sends it through the radiators or underfloor heating of your home (heating circuit). The hot water pumped into the heating circuit exits the boiler at a specific heating flow temperature, emits its heat into the rooms and flows back into the boiler once cooled to return temperature. The heating water is then heated again.

3.2.2 Hot water production with domestic hot water cylinder (VU boiler)

When you open a hot water tap (sink, shower, bath, etc.), the hot water is taken from the domestic hot water cylinder. Cold water then flows into the domestic hot water cylinder in its place. If the hot water temperature in the domestic hot water cylinder falls below the value set, then the boiler operates automatically and reheats the domestic hot water cylinder. As soon as the water in the domestic hot water cylinder has received the set temperature, the boiler switches off.

3.2.3 Hot water production with VUW boiler

When you open a hot water tap (sink, shower, bath, etc.), the boiler operates automatically and supplies hot water at a temperature set by you.

When you close the hot water tap, the boiler automatically stops producing hot water.

If you have activated Comfort mode, the boiler supplies you with hot water at the requested temperature without you having to wait for the water to heat up.



To prevent unnecessary energy loss, do not set the temperature higher than is required.

3.2.4 Hot water production with VUI boiler

The hot water production with additional stratified cylinder functions in the same way as on the VUW boiler (→ **Section 3.2.3**).

In addition, you can activate the heating of the stratified cylinder by switching on Comfort mode. This uses special charging technology to ensure that you have a similar hot water convenience as you would get with a much bigger conventional domestic hot water cylinder. You immediately get hot water at the required temperature without having to wait for the water to heat up and you have a larger hot water volume at your disposal.

4 Operation

4 Operation

4.1 Overview of the control elements

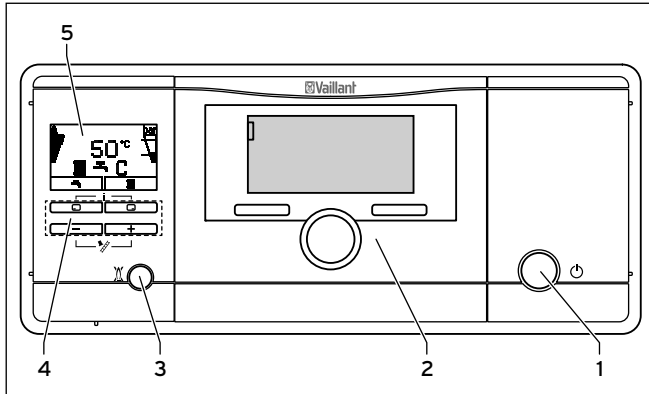

4.1 ecoTEC plus control elements

- 1 On/off button for switching the boiler on or off
- 2 Controller (accessory)

The Digital Information and Analysis System consists of:

- 3 Reset button to clear certain faults
- 4 Operating buttons
- 5 Display

4.2 Digital Information and Analysis System (DIA)

The ecoTEC plus boiler is equipped with a digital information and analysis system (DIA system). It consists of a display showing symbols and plain text, along with 5 operation buttons. This system provides information on the operating status of your boiler and helps you deal with problems.

The display lights up,

- if you switch the boiler on or
- if you press a button for the DIA system when it is switched on. At first, pressing this button does not trigger any other function.

The light automatically switches off after one minute if you do not press any button.

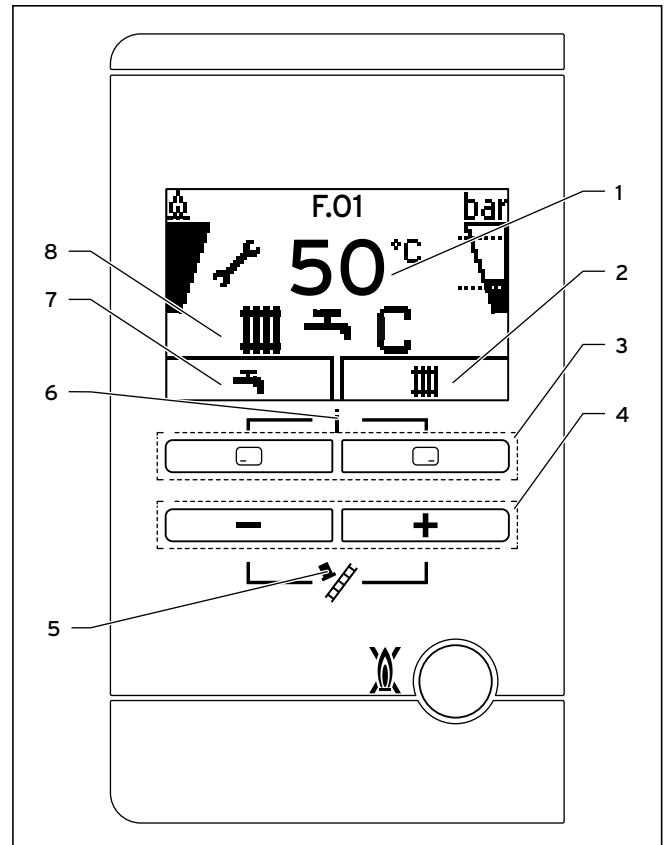

4.2 DIA system with possible symbol displays

- 1 Display indicating the current heating flow temperature, the filling pressure of the heating system, the operating mode, a fault code or other additional information in plain text
- 2 Display of the current configuration of the right-hand selection button (after switching on the boiler and in the basic display: = heating)
- 3 Left and right-hand selection buttons
- 4 Minus and plus button
- 5 Chimney sweep mode (for chimney sweeps only)
- 6 Access to the menu for additional information
- 7 Display of the current configuration of the left-hand selection button (after switching on the boiler and in the basic display: = hot water production)
- 8 Display of the symbols for the active operating status

Displayed symbols



Flame:
Permanently on: Correct burner operation; Burner on



Display of the current burner modulation rate (bar graph display)

bar



Display of the current filling pressure of the heating system (bar graph display).
The filling pressure must be in the mid range between the two dotted lines.

Permanently on: The filling pressure is within the permitted range.

Flashing: The filling pressure is outside of the permitted range (→ **Section 5.1.3**).



Heating mode active

Permanently on: Heat demand, heating mode

Flashing: Burner on in heating mode



Hot water generation active

For VUI/VUW boilers:
Permanently on: In draw-off mode before the burner is on

Flashing: Burner on in draw-off mode

On VU boilers:
Permanently on: time slot activated for hot water generation

Flashing: Domestic hot water cylinder is being heated, burner on



Only on VUI/VUW boilers:
Comfort mode active

Permanently on: Comfort mode is activated

Flashing: Comfort mode is active, burner on



Service required. In the "Live monitor", you can read further information about the reason for the service (→ **Section 8.2**).

Additional symbols:



Summer mode active
Heating mode is switched off



Boiler anti-cycling time is active
This function is used to prevent frequent on/off operations, and therefore contributes to prolonging the life of your boiler.
The symbol also appears if the boiler is in a waiting period.



Fault in the boiler. Appears instead of the basic display (→ **Section 4.4**).
F.XX A plain text display explains the displayed fault code.
Example: F.10 Flow NTC short circuit.

4.3 Operating concept

You can operate the boiler using the selection buttons and the plus/minus buttons.
Both selection buttons have a soft key function. This means that their function can change.

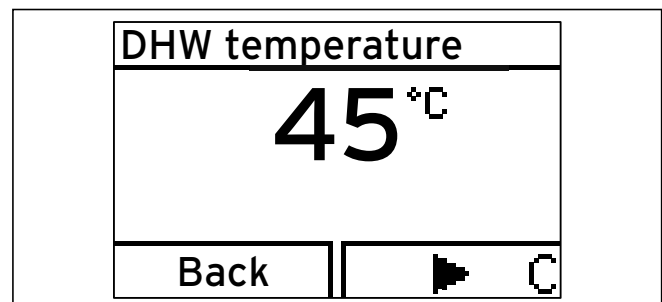



4.3 Display after pressing the left-hand selection button

If, for example, you press the left-hand selection button in the basic display (→ **Section 4.4**), the current function switches from "🔥" (hot water temperature) to "Back".

- With the left-hand selection button :
- you can navigate directly to set the hot water temperature
 - you can cancel the change to a set value or the activation of an operating mode
 - you can go one selection level higher in the menu

- With the right-hand selection button :
- you can navigate directly to set the heating flow temperature, to the precise value of the water pressure of the heating system and to activate Comfort mode
 - you can confirm a set value or the activation of an operating mode
 - you can go one selection level lower in the menu

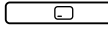
4 Operation

With both selection buttons  +  at the same time:

- you can navigate to the menu (→ **Section 8**)

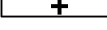
With the minus button  or the plus button :

- you can go back and forth between the individual points of the entry list in the menu
- you can increase or decrease a selected set value

Adjustable values are always displayed as flashing. You must always confirm a change to a value. Only then is the new setting saved.

You always have the option to cancel the change to a setting or the reading of a value by pressing the left-hand selection button.

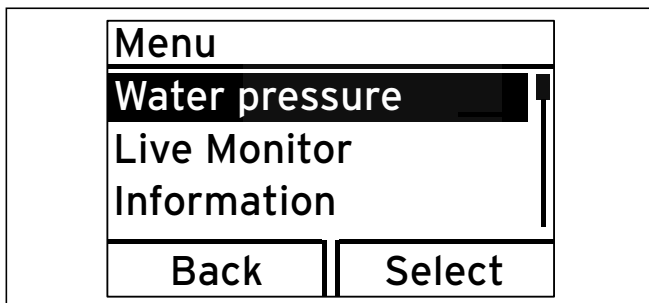

4.4 Selecting a list entry in the menu

A highlighted object is indicated in the display inversely (light text on dark background).



If you do not press any buttons for more than 15 minutes, the display returns to the basic display. Changes that are not confirmed will not be applied.

4.4 Basic display

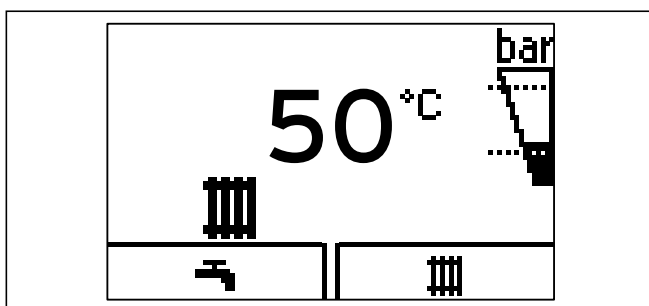

4.5 Basic display

In the normal operating status, you can see the basic display in the display. The basic display shows the current status of the boiler. If you press a selection button, the relevant activated function is displayed in the display. If the display becomes dark, the light is first switched on by the first

press of the button. In this case, to trigger the button function, you must press the button again.

You can switch back to the basic display by:

- pressing the left-hand selection button and exiting the selection levels
 - not pressing any button for longer than 15 minutes.
- Changes that are not confirmed will not be applied.

If there is a fault message, the basic display switches to a plain text display of the fault message.

From the basic display, you can directly change and read the most important settings and information by pressing the selection buttons.

The functions that are available depend on whether a controller is connected to the boiler.

4.5 Operating levels

The boiler has two operating levels.

Operating levels for the operator

The operating level for the operator offers you the most frequently used setting options that do not require any special prior knowledge and displays the most important information. You can access additional information using a menu.

Operating level for the heating engineer

The operating level for the heating engineer must only be operated with expertise and is therefore protected by a code. This level is used by the competent person to adjust the parameters for the boiler to the heating system.

5 Operation

5.1 Putting the boiler into service.

5.1.1 Opening/closing the isolator devices



If the boiler is fitted with a bottom cover, the isolating devices are under this cover.

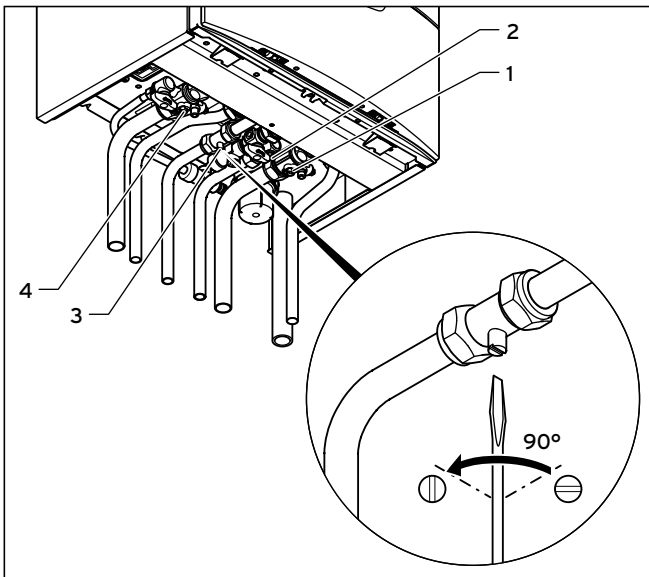

5.1 Opening the isolator devices on the VUW boiler

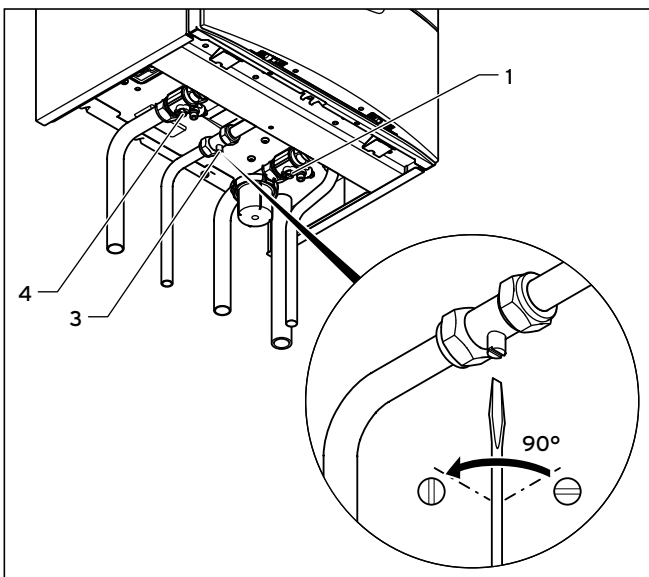

5.2 Opening the isolator devices on the VU boiler

The isolator devices are open if the slot for the screwdriver is parallel to the pipes.

- Open the gas isolator cock (3).
- Check that the heating flow (4) and heating return (1) isolator devices are open. Open these if they are closed.

For the unit version VUW and VUI:

- Also open the cold water stop valve (2).
- In order to check this, open a hot water tap at a draw-off point and check that water flows out.

Closing isolator devices

The isolator devices are closed if the slot for the screwdriver is at a right-angle to the pipes.

5.1.2 Switching on the boiler



Caution!

Risk of damage caused by frost.

Frost protection and monitoring devices are only active while the boiler is connected up to the power supply and your boiler is switched on using the on/off switch.

- Do not isolate the boiler from the power mains.
- Leave your boiler switched on at the on/off switch.

To ensure that the frost protection and monitoring devices remain active, switch your boiler on and off using the controller (see the corresponding operating instructions for more information on this).

→ **Section 10** describes how to fully shut down your boiler.

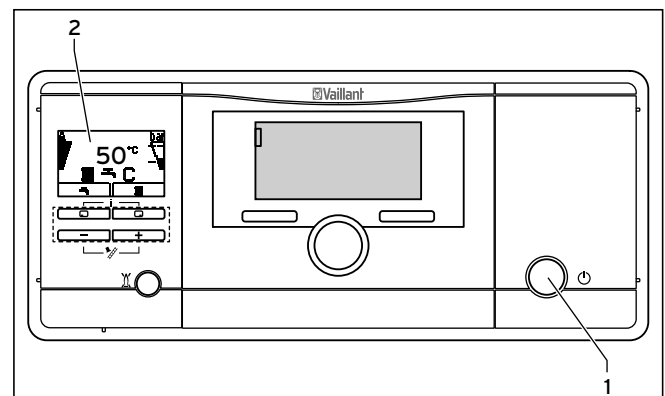

5.3 Switching on the boiler

- Press the on/off switch (1) to switch on the boiler.

5 Operation

If the boiler is switched on, the current heating flow temperature and other information will appear in the display (2) (→ Fig. 4.5).

To set your boiler to suit your needs, read → Section 5.2 to Section 5.4 which describe the setting options for hot water production and the heating mode.

5.1.3 Checking the fill level of the heating system



Caution!
Low filling pressure can cause damage to the unit.

Operating the heating system with low filling pressure can cause damage to the boiler and the heating system. The boiler switches off automatically when the filling pressure falls too low.

- Fill up the heating system as soon as the filling pressure falls below 0.08 MPa (0.8 bar).

To avoid operating the system with insufficient water and to prevent possible damage associated with this, your boiler is fitted with a pressure sensor and a digital pressure display. To ensure that the heating system operates smoothly, the filling pressure when the heating system is cold must be between 0.1 MPa and 0.2 MPa (1.0 bar and 2.0 bar) or lie between the two dotted lines in the bar graph display.

If the heating system extends over several storeys, a higher filling pressure may be required for the heating system.

- Ask your approved competent person for details about this.

If the pressure falls below 0.08 MPa (0.8 bar), the right-hand bar graph display and the current pressure flash in the display.

- Fill up the heating system (→ Section 5.1.4).



Switch off the boiler if the filling pressure in the heating system falls below 0.05 MPa (0.5 bar). The display alternates between the fault message F.22 and the current filling pressure.

The heating system must be topped up with water before the boiler can be put into operation again. As soon as the system has been topped up with sufficient water, the message disappears automatically after approx. 20 seconds. If the pressure drops frequently the reason for the loss of hot water must be identified and eliminated

- Contact your heating engineer.

You can see the filling pressure in the right-hand bar graph display or display the exact value using the selection buttons to the right of the display.

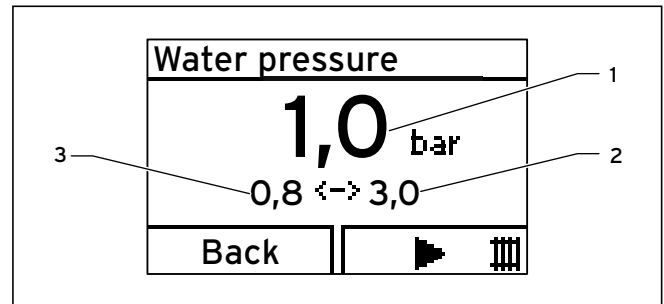

5.4 Digital display of filling pressure

- Press the right-hand selection button  twice.

The current filling pressure (1) and the minimum (3) or maximum water pressure (2) that is to be set appear in the display.

5.1.4 Filling the heating system



Caution!
Risk of damage caused by tap water that is extremely calciferous or corrosive or contaminated by chemicals.

Unsuitable tap water damages the seals and diaphragms, blocks components in the boiler and heating system through which the water flows and causes noise.

- Only fill the heating system with suitable tap water.
- In case of doubt, consult your approved competent person regarding this.

To fill up and to refill the heating system, you can normally use tap water. In exceptional cases, however, the water quality may not be suitable for filling the heating system because the water is highly corrosive or calciferous.

- If this is the case, contact your approved heating engineer.

The heating system is filled via a filling cock provided by the installer.

- Ask your approved competent person where the filling cock is located.
- Ask your approved competent person to explain how to fill the heating system.

You can show the exact filling pressure in the display (→Section 5.1.3).

Proceed as follows to fill the heating system:

- Open all radiator valves (thermostatic radiator valves) of the heating system.
- Connect the filling cock for the heating system, as explained by your approved competent person, to a cold water draw-off valve.
- Open the filling cock slowly.
- Fill it with water using the draw-off valve until the required filling pressure is reached in the display.
- Close the draw-off valve.
- Bleed all the radiators.
- Then check the filling pressure on the display.
- Fill with more water if required.
- Close the filling cock.
- Remove the connection between the filling cock and the draw-off valve.
- Return to the basic display.

5.2 Setting the heating flow temperature

5.2.1 Setting the heating flow temperature without a controller connected

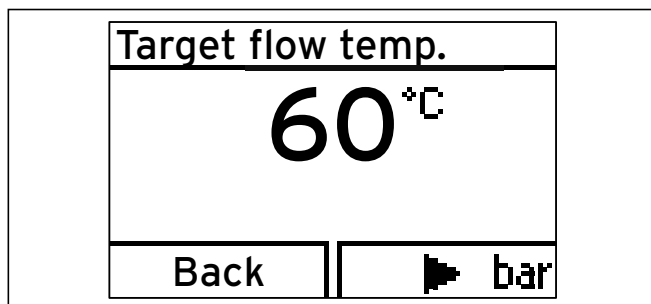

5.5 Setting the heating flow temperature

If no external controller is connected to the boiler, set the heating flow temperature according to the respective outside temperature as follows:

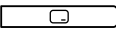
- Press the right-hand selection button  ("OK").

The value of the heating flow temperature appears in the display.

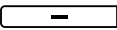
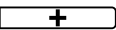
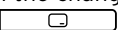
- Use the minus button  or the plus button  to change the heating flow temperature.
- Confirm the change by pressing the right-hand selection button  ("OK").

The heating flow temperature is factory-set for temperatures up to 75°C.

If higher (or lower) values can be set on your boiler, this means that your approved competent person has calibrated your unit to adjust the maximum temperature to your heating system.

5.2.2 Using a controller to set the heating flow temperature

If your boiler has a weather compensator or a room thermostat control system, you must make the following settings:

- Set the maximum heating flow temperature on the boiler (→ **Section 5.2.1**).

The actual heating flow temperature is automatically adjusted by the controller (for information about this, see the controller operating instructions).

5.3 Hot water production with VUW boilers



Danger!

Risk of being scalded by hot water.

There is a danger of scalding at the hot water draw-off points if the hot water temperatures are greater than 60°C. Young children and the elderly can even be at danger at lower temperatures.

- Select the temperature so that nobody is at risk.



Danger!

Possible danger to life from legionella!

If the boiler is used to reheat water in a solar-based drinking water heating system, note the following:

- Set the minimum hot water temperature to 60°C.



Caution!

Risk of damage caused by calcification.

If the water hardness is greater than 3.57 mol/m³ (= 357 mg/l CaCO₃), there is a risk of calcification.

- Set the water temperature to a maximum of 50°C.

5 Operation

5.3.1 Setting the hot water temperature

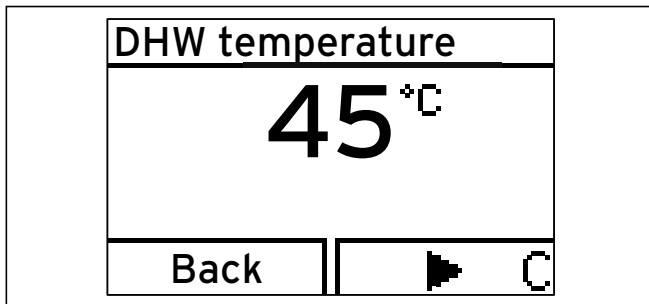

5.6 Setting the hot water temperature

- Press the left-hand selection button ("←"). The hot water temperature that is set is shown flashing on the display.
- Use the minus button or the plus button to change the hot water temperature.
- Confirm the change by pressing the right-hand selection button ("OK").

If you have connected an eBUS auto controller to the boiler, you can set the hot water target temperature on the controller.

- Ask your approved competent person whether an eBUS auto controller is connected.

If you are using an eBUS auto controller:

- Set the hot water temperature on the boiler to the maximum possible temperature.
- Set the desired hot water temperature (hot water target temperature) on your controller.

5.3.2 Activating/deactivating Comfort mode

Comfort mode immediately supplies you with hot water at the required temperature, without you having to wait for the water to heat up. To do this, the plate-type heat exchanger of the ecoTEC plus is kept at your selected temperature level.

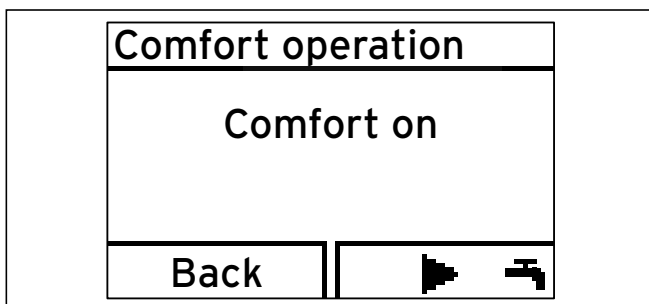

5.7 Switching Comfort mode on and off

- Press the left-hand selection button ("←").

- Press the right-hand selection button ("→").

"Comfort mode on" or "Comfort mode off" flashes in the display.

- Use the minus button or the plus button to activate or deactivate the comfort mode.
- Confirm the change by pressing the right-hand selection button ("OK").

When you have activated Comfort mode, the symbol "C" is shown in the basic display.

When you have deactivated Comfort mode, the symbol "C" goes out in the basic display.

5.3.3 Setting the cylinder charging mode (VUI 937 only)

If an additional stratified storage tank is connected, you can switch cylinder charging on and off using the controller on your boiler.

"Cylinder charging mode" refers to the process for heating up the cylinder.



Cylinder charging is deactivated ex-works and must be activated during initial start-up.

The cylinder charging of the layer storage tank is only active if Comfort mode is switched on.

If Comfort mode is activated, the symbol "C" appears in the display (→ **Section 5.3.2**).

When cylinder charging is switched on, the following temperatures can be set for the hot water temperature (→ **Section 5.3.1**):

- **minimum temperature** **50 °C**
- **maximum temperature** **65 °C**

When cylinder charging is switched off, the following temperatures can be set for the hot water temperature (→ **Section 5.3.1**):

- **minimum temperature** **35 °C**
- **maximum temperature** **65 °C**

If cylinder charging is switched off, the storage tank is not held at temperature. If you draw off the water, the boiler switches on and, in this case, only operates on the through-flow principle.



Danger!
Risk of scalding.

VUI 937 only: The boilers are equipped with an automatic Legionella protection function:

If the temperature in the hot water domestic hot water cylinder falls below 50 °C, the cylinder is heated up to 70 °C once every 24 hours.

- If this is the case, try not to draw off any water.

Your approved competent person can switch off the Legionella protection function. Ask your approved competent person for details about this.

Switching cylinder charging on and off

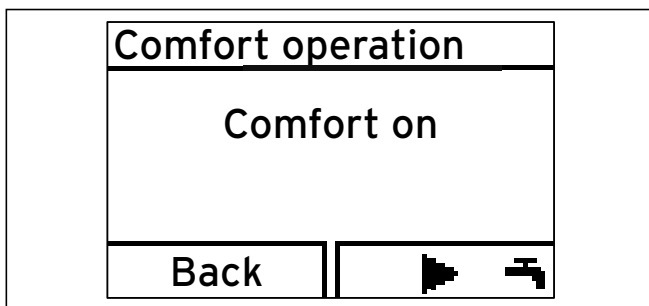

5.8 Switching cylinder charging (Comfort mode) on and off

- Press the left-hand selection button ("←").
- Press the right-hand selection button ("→").

"Comfort mode on" or "Comfort mode off" flashes in the display.

- Use the minus button or the plus button to activate or deactivate Comfort mode.
- Confirm the change by pressing the right-hand selection button ("OK").

When you have activated Comfort mode, the symbol "C" is shown in the basic display.

When you have deactivated Comfort mode, the symbol "C" goes out in the basic display. The boiler now operates in the through-flow principle; the cylinder is not held at temperature.

- Set the cylinder temperature using the hot water temperature setting (→ **Section 5.3.1**).

5.4 Hot water production with VU boilers



Danger!
Risk of being scalded by hot water.

There is a danger of scalding at the hot water draw-off points if the temperatures are greater than 60 °C. Young children and elderly persons are particularly at risk, even at lower temperatures.

- Select the temperature so that nobody is at risk.



Danger!
Possible danger to life from legionella!

In domestic hot water cylinders there is a risk of legionella forming, which can cause illness.

- If the boiler is used for post-heating within a solar-supported drinking water heating system, set the hot water temperature to at least 60 °C.



Caution!
Risk of damage caused by calcification.

If the water hardness is greater than 3.57 mol/m³ (= 357 mg/l CaCO₃), there is a risk of calcification.

- Set the water temperature to a maximum of 50 °C.

To produce hot water in conjunction with the VU unit type, a VIH-type domestic hot water cylinder must be connected to the boiler.

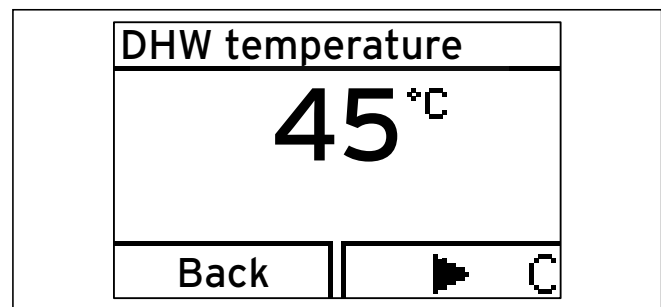

5.9 Setting the hot water temperature

- Press the left-hand selection button ("←"). The hot water temperature that is set is shown flashing on the display.

- Use the minus button or the plus button to change the hot water temperature.
- Confirm the change by pressing the right-hand selection button ("OK").

If you have connected an eBUS auto controller to the boiler, you can set the hot water target temperature on the controller.

5 Operation

- Ask your approved competent person whether an eBUS auto controller is connected.

If you are using an eBUS auto controller:

- Set the hot water temperature on the boiler to the maximum possible temperature.
- Set the desired hot water temperature (hot water target temperature) on your controller.

5.5 Setting a room thermostat or weather compensator

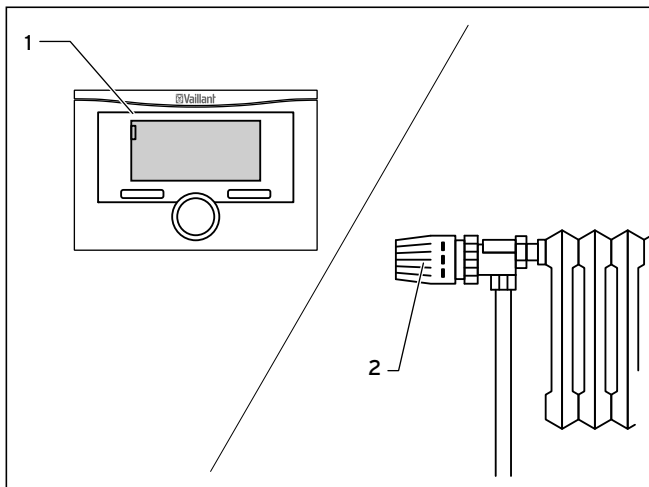

5.10 Setting the room temperature controller/weather compensator

- Set the room thermostat, weather compensator (1) and thermostatic radiator valves (2) as specified in the operating instructions for these accessories.

5.6 Switching off the functions of the boiler

5.6.1 Switching off hot water production (VU boiler)

If a domestic hot water cylinder is connected, you can switch off the cylinder charging without switching off the heating mode.

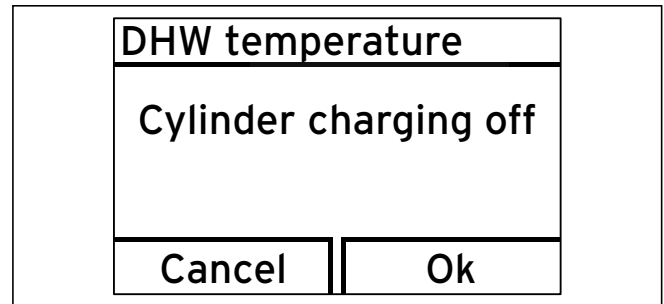

5.11 Switching off cylinder charging

- Press the left-hand selection button ("←"). The hot water temperature that is set is shown flashing on the display.

- Use the minus button to set the hot water temperature to "Cylinder charging off"
- Confirm the change by pressing the right-hand selection button ("OK").

Cylinder charging is switched off. Only the frost protection function for the cylinder remains active.

To switch the cylinder charging on again:

- Use the plus button to set your required hot water temperature.
- Confirm the change by pressing the right-hand selection button ("OK").

5.6.2 Switching off Heating mode (summer mode)

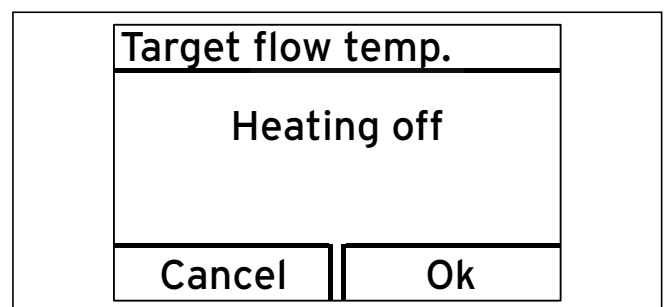

5.12 Switching off Heating mode (summer mode)

You can switch off the heating mode in summer without switching off the hot water supply.

- Press the right-hand selection button ("OK"). The value of the heating flow temperature appears in the display.

- Use the minus button to set the hot water flow temperature to "Cylinder charging off".
- Confirm the change by pressing the right-hand selection button ("OK").

Heating mode is switched off. The symbol appears on the display.

To switch the heating mode on again:

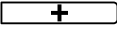
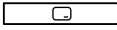
- Use the plus button  to set your required heating flow temperature.
- Confirm the change by pressing the right-hand selection button  ("OK").

5.7 Temporarily shutting down the boiler



Caution!
Risk of damage caused by frost.

Anti-freeze and monitoring devices are only active while the boiler is connected up to the power mains and the on/off switch is on.

- Do not isolate the boiler from the power mains.
- Leave your boiler switched on at the on/off switch.
- Only switch the boiler on and off in normal mode using the controller.
- Make sure that the boiler cannot become damaged by frost.

5.8 Protecting the heating system against frost

5.8.1 Activating the frost protection function

Your Vaillant ecoTEC plus boiler is fitted with a frost protection function:

If the heating flow temperature falls below 5 °C when the on/off switch is on, the boiler comes into operation and heats the heat generation circuit to approx. 30 °C on both the heating side and the hot water side (if available).



Caution!
Risk of damage caused by frost.

The frost protection function cannot guarantee flow through the entire heating system, which means that parts of the heating system may freeze and become damaged.

- Make sure that the boiler remains on whilst you are away.
- Make sure that the rooms are heated sufficiently.

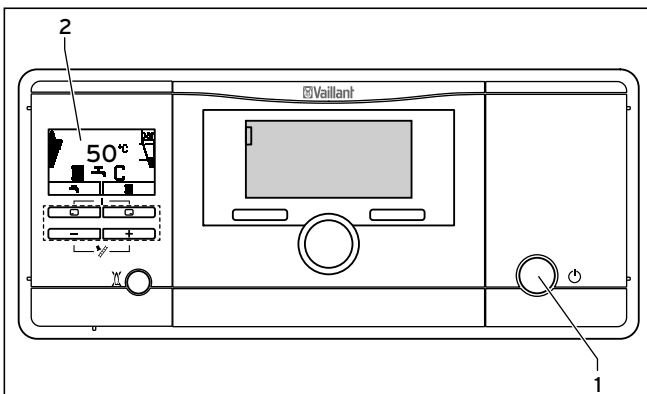

5.13 Switching off the boiler

- Press the on/off switch (1) to switch the boiler off.

If the boiler is switched off, the display (2) turns off.



If the boiler is going to be unused for longer periods (e.g. holiday), you should also close the gas isolator cock and the cold water stop valve, but only if there is no risk of frost.

5.8.2 Draining the heating system

Another way to protect the heating system and the boiler from frost when they are switched off for a very long time is to drain them. You must ensure that the heating system and boiler are completely drained.

All the cold and hot water pipes in the house and in the boiler must also be drained.

- Ask your heating engineer to drain the heating system.

6 Energy saving tips

Fitting a weather compensator

Weather compensators regulate the heating supply temperature according to the outside temperature. Thus it is ensured that heat in excess of what is required at that moment is not generated. In addition, desired heating and set-back phases (e.g. at night) are automatically turned on and off by using integrated time programmes.

Weather compensators combined with thermostatic radiator valves are the most economical form of heating regulation.

Operating the heating system in energy-saving mode

- Reducing the room temperature at night and in your absence.

The simplest and most reliable way is to be able to reduce the room temperature using the controller with individually selectable timer programmes.

- At such times, set the room temperature approx. 5 °C lower than during full heating times.

If the room temperature falls by more than 5 °C, you are not saving any additional energy because increased heating capacity would then be required for the next full heating period. Only for longer absences, e.g. during holidays, is it worthwhile to further lower the temperatures.

Caution.

- In winter, make sure that adequate frost protection is maintained (→ **Section 5.8**).

Room temperature

- Set the room temperature only as high as would be enough for your comfort level.

Each extra degree would cause an increased energy consumption of about 6%.

- Adjust the room temperature according to the purpose of use of the room.

For example, normally, bedrooms or rooms that are seldom used are heated to 20 °C.

Uniform heating

- Heat all of the rooms in your dwelling to the same level and according to their use.

If you only heat one room or individual rooms in your dwelling, the adjacent unheated rooms will also be heated through walls, doors, windows, roofs and floors and this heating will be unregulated. The capacity of the radiators for the heated rooms is insufficient for this type of operation. The heated rooms are then not heated sufficiently (the same effect is caused if doors between heated and unheated rooms (or rooms that are heated to a limited degree) are left open).

Thermostatic radiator valves and weather compensators or room thermostats

Thermostatic valves on all radiators maintain the room temperature exactly once it is set. You can adjust the room temperature to suit your individual requirements and ensure effective operation of your heating system using thermostatic valves in combination with a room thermostat or a weather compensator.

This is how a thermostatic valve works: If the room temperature rises above the value set on the sensor head, the thermostatic radiator valve shuts off automatically and when the temperature drops below the defined value, it opens again.

Do not obstruct the controller

- Do not obstruct your controller with furniture, curtains or other objects.

The controller must be able to record the circulating room air unhindered. Covered thermostatic radiator valves can be equipped with remote sensors and thus still work.

Ventilating living rooms

- During the heating period, open windows only for ventilation and not for temperature regulation.

A brief ventilation boost is more effective and energy-saving than windows that are kept open for a long time. Close all the thermostatic valves in the room during ventilation.

- If you have a room thermostat, set it to the minimum temperature.

This guarantees adequate exchange of air without unnecessary loss of energy and cooling off.

Setting the operating mode

- In warmer seasons, when the dwelling needs no heating, turn the heating to summer mode.

The heating mode is then switched off. The boiler and system remain ready for operation for the hot water production.

Setting the hot water temperature

- Only heat the warm water up to the extent that is necessary for use.

Any further heating results in unnecessary power consumption and hot water temperatures of more than 60 °C also lead to increased limescale reduction.

Switching on comfort mode (only VUW):

Comfort mode immediately supplies you with hot water at the required temperature, without you having to wait for the water to heat up. For this, the hot water heat exchanger is kept at a preselected temperature level.

If you do not need hot water for a long period, it is recommended to turn off comfort mode to save energy further.

Energy-conscious use of water

Energy-conscious use of water can reduce your bills considerably. For example, taking a shower instead of a bath: whereas about 150 litres of water are required for a bath, a modern shower equipped with water-saving fittings only requires a third of this water quantity.

By the way: A dripping water tap wastes up to 2000 litres of water and a leaking toilet flush wastes up to 4000 litres of water each year.

Run circulation pumps only if needed (VU only)

Circulation pumps increase convenience when it comes to hot water production. But they also need power. And circulating hot water that is not used cools off when passing through pipes and then needs to be reheated.

- Operate circulation pumps only when hot water is actually needed for the household.
- Use a weather compensator or autotimers to set time programmes for your circulation pump.
- Or turn on the circulation only for specific needs for a specific period of time by using a button or switch installed near a frequently used draw-off point.
- For more information, consult your competent person.

7 Troubleshooting

7 Troubleshooting



Danger!

Risk of injury and material damage due to incorrect maintenance and repairs.

If maintenance is not carried out, or carried out incorrectly, this may adversely affect the operational reliability of your boiler.

- Never perform maintenance or repairs on your boiler by yourself.
- You must employ an approved competent person or Vaillant Service Solutions (0870 6060 777) to complete such work.

7.1 Reading fault messages

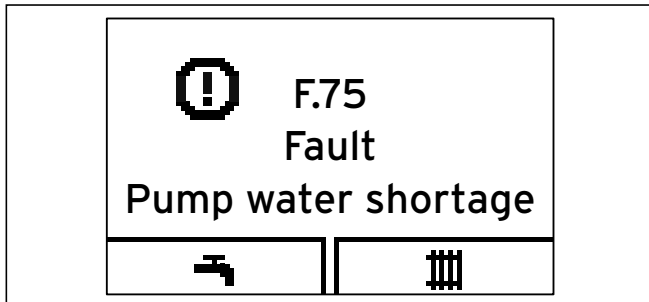

7.1 Fault display

Fault messages have priority over all other displays. If a fault develops in the boiler, the display shows a fault code instead of the basic display. A plain text display explains the displayed fault code.

Example for F.75: "Fault Pump water shortage".

If multiple faults occur at the same time, the display shows the corresponding fault codes for two seconds each in sequence.

- If your boiler displays a fault message, contact your approved competent person.

You can use the "Live monitor" to call status messages about the status of your boiler (→ **Section 8.2**).

7.2 Detecting and rectifying malfunctions

If problems occur whilst operating your boiler, you can carry out the following self-checks:

Problem	Possible cause	Solution
No hot water, heating stays cold; Boiler does not start	Building gas isolator cock closed	► Open building gas isolator cock (→ Section 5.1.1)
	Building power supply switched off	► Switch on building power supply
	On/off switch on boiler switched off	► Switch on the on/off switch on the boiler(→ Section 5.1.2)
	The heating flow temperature is set too low or in the "Heating off" position (→ Section 5.6.2) and/or the hot water temperature is too low	► Set the heating flow temperature to the desired temperature (→ Section 5.2) and/or set the hot water temperature to the desired temperature (→ Section 5.3.1 and 5.4)
	Filling pressure of the heating system too low	► Top up the heating system with water (→ Section 5.1.4)
	Air in the heating system	► Purge the radiators. ► If the problem occurs again: Contact your heating engineer
	Ignition malfunction	► Press the reset button ► If the problem occurs again: Contact your competent person (→ Section 7.4)
DHW mode without any problems; Heating does not start:	No heating demand via the controller	► Check the timer programme on the controller and correct it if necessary. ► Check the room temperature and, if required, correct the target room temperature (→ Section 5.5 ; → Controller operating instructions).

7.1 Detecting and rectifying malfunctions

- If, after checking the points mentioned in **Tab. 7.1**, your boiler still shows signs of a fault, contact your approved competent person to troubleshoot the problem.

7.3 Rectifying a water shortage

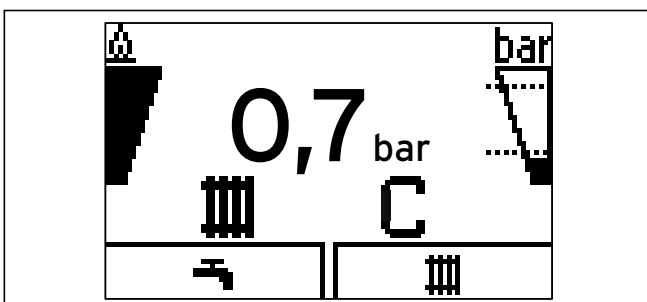

7.2 Display of the filling pressure for the heating system is too low

If the filling pressure for the heating system falls below 0.08 MPa (0.8 bar), the right-hand bar display and the current filling pressure flash in the display.

7 Troubleshooting

In addition, the maintenance symbol (open-ended spanner) is displayed after approx. one minute.

If the filling pressure falls below 0.05 MPa (0.5 bar), the boiler switches off and the fault message F.22 appears in the display. To put the boiler into operation again, you must fill the heating system with water (→ **Section 5.1.3 and 5.1.4**).

7.4 Resolving ignition faults



Caution!
Risk of damage due to improper modifications.

Improper alterations or persistent faults can result in material damage.

- If you are unable to resolve the ignition problem yourself by resetting the boiler three times, then consult your approved competent person.

The boiler will only ignite automatically again once you have reset it manually.

- To reset the boiler manually, press the reset button (3) and hold for one second.
- If you are unable to resolve the ignition problem yourself by resetting the boiler three times, then consult your approved competent person.

7.5 Maintenance message

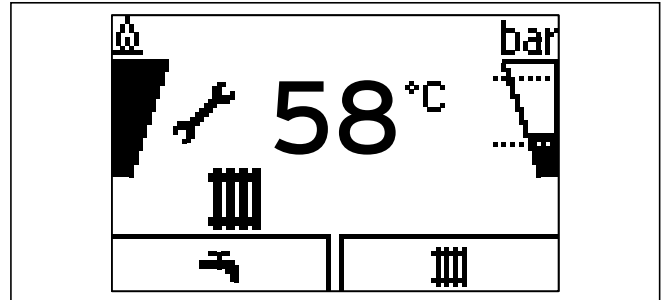

7.4 Maintenance message

If the open-ended spanner is displayed, a service is required for the boiler.

- Consult your skilled tradesman about doing this. The boiler is not in fault mode but continues to operate.
- In the "Live monitor", you can read further information about the reason for the service (→ **Section 8.2**).



If the water pressure is shown flashing at the same time (→ **Section 7.3**), you only have to top up the water (→ **Section 5.1.3 and 5.1.4**).

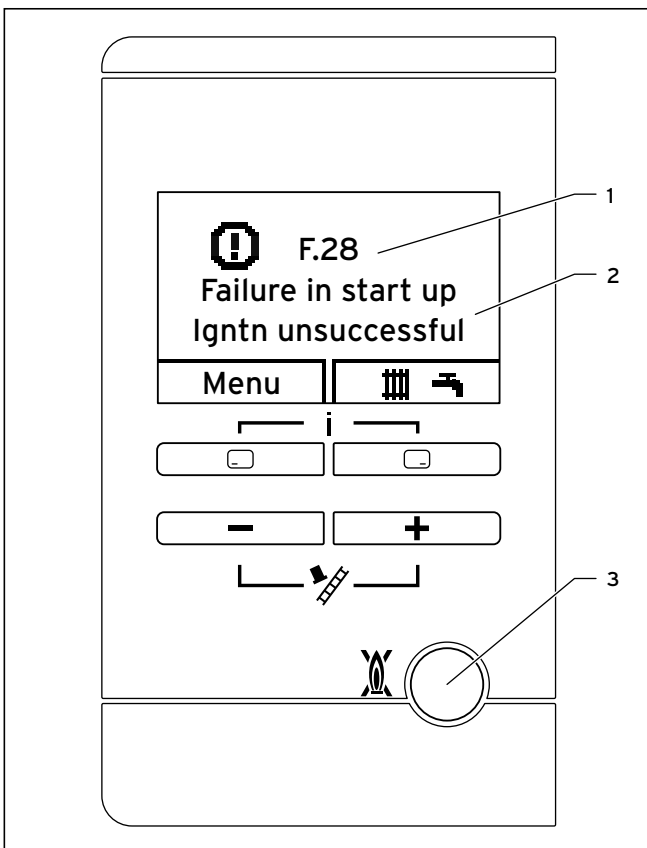

7.3 Resetting the boiler

If the burner fails to ignite after five attempts, the boiler will not operate and switches to "Fault". This is indicated by the fault code F.28 or F.29 (1) and a corresponding plain text display on the display, e.g. for F.28. "Failure during starting, ignition unsuccessful" (2).

8 Additional functions

The digital information and analysis system provides you with further functions via the menu.

8.1 Operation in the menu

You can access this menu by pressing both selection buttons ("i") at the same time.

8.1.1 Structure of the menu

In addition to the direct operation via the selection buttons from the basic menu, the digital information and analysis system has a menu that, in turn, has two selection levels (sublevels).

Through the selection levels, you navigate to the display and setting levels in which you can read or change settings. The selection levels have four display fields.

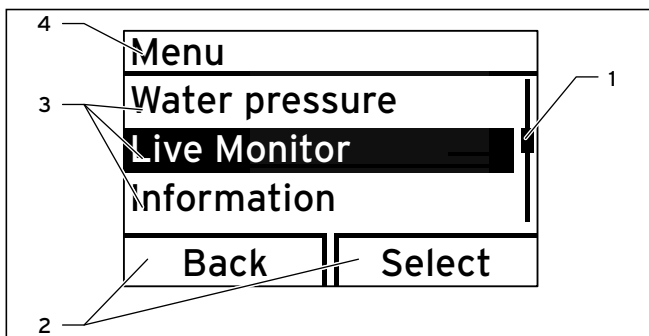

8.1 Display fields in the menu

Key

- 1 Scroll bar (only if there are more list entries than can be shown at once on the display)
- 2 Current functions of the right and left-hand selection buttons (soft key functions)
- 3 List entries for the selection levels
- 4 Name of the selection level



Path details at the start of an instruction on how to access this function are provided at the start, e.g. **Menu → Information → Contact data.**

8 Additional functions

8.1.2 Overview of menu structure

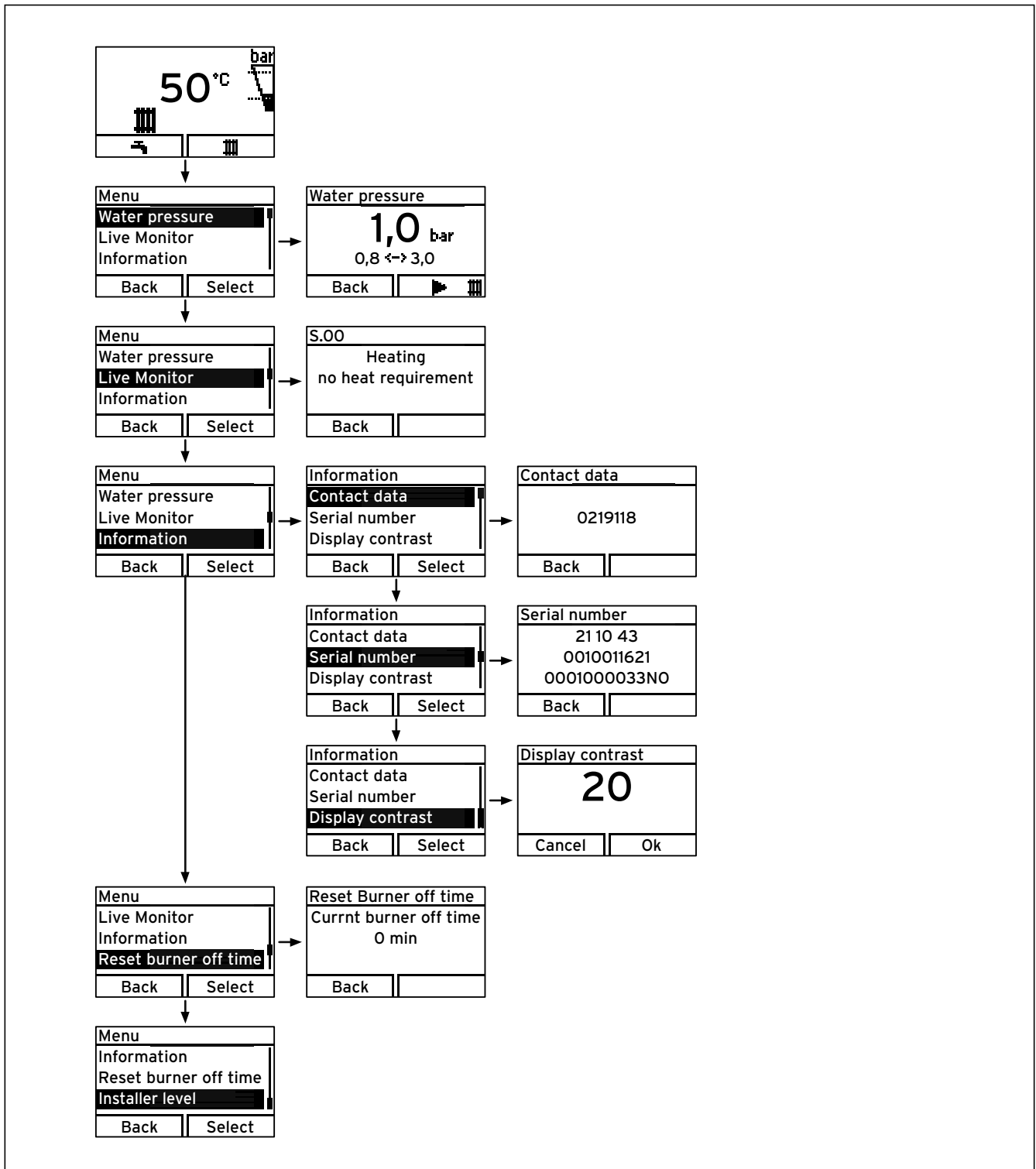

8.2 Overview of menu structure

8.2 Displaying Live monitor (current status of the boiler)

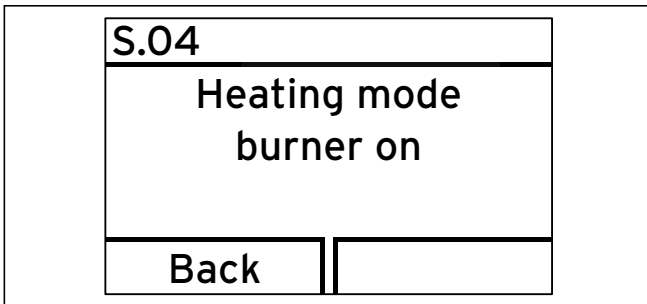

8.3 Displaying Live monitor (current status of the boiler; example)

Menu → Live Monitor

This function allows you to read the current appliance status of your boiler. In addition, the meaning of the message is displayed as plain text. The display is automatically updated if the appliance status changes.

Status code	Meaning
	Displays in heating mode
S.00	Heating, no heat demand
S.02	Heating mode, Water pump running
S.03	Heating mode, Ignition sequence
S.04	Heating mode, Burner ignited
S.06	Heating mode, Fan overrun
S.07	Heating mode, Pump overrun
S.08	Heating, remaining cut-off time xx min
	Displays in DHW mode (VUW boiler)
S.10	Hot water demand via fan sensor
S.14	DHW mode, Burner on
	Displays in cylinder charging mode
S.20	DHW demand
S.22	DHW mode, Pump running
	Special cases
S.31	No heat demand, summer operating mode
S.34	Heating mode, frost protection
S.40	Comfort safety mode active

8.1 Possible appliance statuses (selection)

8.3 Setting the display contrast

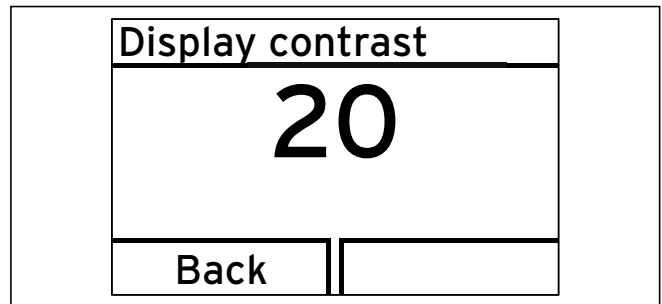

8.4 Setting the display contrast

Menu → Information → Display contrast





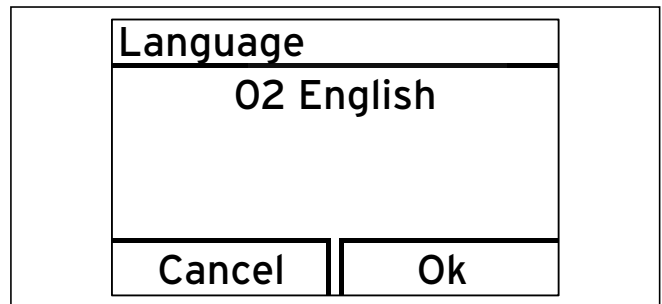

Using this function, you can set the display contrast in relation to the brightness of the surroundings, to ensure that the display is clearly legible.

8.4 Setting the language



8.5 Setting the language

Your approved competent person should have set the boiler to your desired language. If you wish to set another language, you can proceed as follows:



- ▶ Press **and hold** the right-hand selection button  and the plus button  **at the same time.**
- ▶ **Also** press the reset button briefly.
- ▶ **Continue to press and hold** the right-hand selection button  and the plus button  until the display offers you the option to set the language.
- ▶ Use the minus button  or plus button  to select your desired language.
- ▶ Confirm the change by pressing the right-hand selection button  ("OK").

You must confirm the set language twice to ensure that you have not accidentally set an incorrect language.

8 Additional functions



If you have accidentally set a language that you cannot understand, you can change this as described above.

- Use the minus button  or plus button  to scroll until your language appears.

8.5 Displaying contact data for the competent person

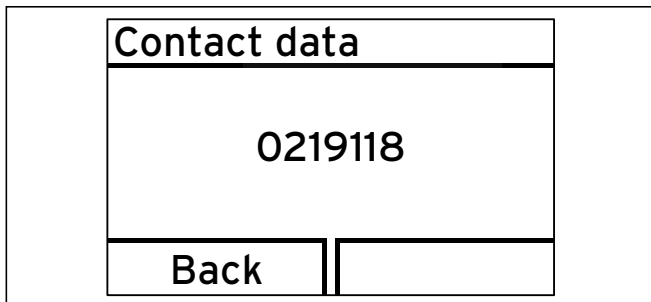

8.6 Displaying contact data

Menu → Information → Contact data

If your competent person has entered their telephone number during the installation, you can read this data under "Contact data".

8.6 Displaying the serial number and article number

Menu → Information → Serial number

"Serial number" shows the serial number of the boiler, which the approved competent person may require from you.

The article number is found in the second line of the serial number.

The serial numbers are also located on a plate, which is stuck behind the front flap on the underside of the boiler in a plastic fish plate.

8.7 Reset burner off time (resetting burner anti-cycling time)

Menu structure → Reset burner off time



This function must only be operated by your approved competent person.

9 Service



Danger!
Risk of injury and material damage due to incorrect maintenance and repairs.

If maintenance is not carried out, or carried out incorrectly, this may adversely affect the operational reliability of your boiler.

- Never attempt to perform maintenance work or repairs on your water boiler by yourself.
- Always employ a recognised heating engineer.

9.1 Servicing the boiler

Permanent operational readiness and safety, reliability and a long working life require inspections and maintenance work to be carried out annually on the boiler by your approved competent person.

Regular servicing ensures maximum efficiency and economical operation of your boiler.

We recommend making a maintenance agreement.

9.2 Caring for your boiler



Caution!
Unsuitable cleaning agents can cause damage!

Unsuitable cleaning agents (scouring or other cleaning agents) can damage the exterior, the fittings or the controls.

- Do not use sprays, solvents or cleaning agents containing chlorine.

- Clean the exterior of your boiler with a damp cloth and a little solvent-free soap. Do not use any detergent.

10 Decommissioning

10 Decommissioning

- Contact a heating engineer to disconnect the boiler permanently.

10.1 Disposing of the boiler

Do not dispose of your Vaillant ecoTEC plus boiler or any of its accessories in the household waste.

- Make sure the old unit and any accessories are disposed of properly.
- Observe national regulations.

10.2 Disposing of the packaging

Arrange for the approved heating engineer who installed the boiler to dispose of the transport packaging.

11 Manufacturer's guarantee and works customer services

11.1 Factory guarantee

Two year guarantee for ecoTEC plus appliances

Vaillant undertakes to rectify any manufacturing defect that occurs within twenty-four months of the installation date.

For the 2nd year of the guarantee to be valid an annual service must be carried out by a competent person approved at the time by the Health and Safety Executive one year after installation.

The cost of this annual service is not included in the guarantee.

Registering with us

Registration is simple. Just complete the Guarantee Registration Card and return to Vaillant within 30 days of installation. Your details will then be automatically registered within the Vaillant scheme.

Note: No receipt will be issued.

Immediate help

If your Vaillant boiler develops a fault your first action should be to contact your installer, as his professional assessment is needed under the terms of our Guarantee. If you are unable to contact your installer, phone Vaillant Service Solutions: 0870 6060 777

11.2 Vaillant Service

To ensure regular servicing, it is strongly recommended that arrangements are made for a Maintenance Agreement. Please contact Vaillant Service Solutions (0870 6060 777) for further details.

12 Glossary

Air/flue gas duct

The air/flue gas duct consists of all components that route combustion air to the boiler or exhaust gas from the boiler.

Burner

The burner on a gas-fired condensing boiler is the component on whose surface the gas/air mix is control-burnt.

Calorific value

Unlike the heating value, the calorific value of a fuel describes the total useable heat during combustion, based on the quantity of fuel used, including the condensation heat in the steam. Condensing boilers use this additional condensation heat to achieve much higher efficiency levels than conventional boilers.

Controller

The controller is the interface to the boiler and can be used to adjust the room temperature, hot water temperature, heating times or night-time temperature reduction. A distinction is made between room thermostat, weather compensator and solar controller.

Cylinder charging

Cylinder charging mode refers to the process for heating up the cylinder.
See also hot water generation.

eBUS

The abbreviation eBUS is short for energyBUS. The eBUS is a special cable system used in the heating technology field, which is used for communication between the heating technology components (e.g. controller, boiler, vrnetDIALOG).

Frost protection

The frost protection function protects your heating system and dwelling from frost damage. If the heating flow temperature falls below 5 °C when the on/off switch is on, the boiler comes into operation and heats the heat generation circuit to approx. 30 °C.

Heating flow temperature

Your boiler heats water which is pumped through your heating system. The temperature of this hot water as it leaves the boiler is referred to as the heating flow temperature.

Hot water production in VU boilers

Your boiler heats the water in the domestic hot water cylinder to the selected target temperature. If the temperature in the domestic hot water cylinder falls by a specific amount, the water is heated up again to the target temperature.

Hot water production in VUW boilers

In the VUW boiler, the water is heated directly in the through-flow principle.

Comfort mode immediately supplies you with hot water at the required temperature, without you having to wait for the water to heat up. In order to do this, the hot water heat exchanger is kept at a preselected temperature level.

Legionella

Legionella are water-borne bacteria which can quickly propagate and cause serious lung diseases. Legionella bacteria occur wherever heated water provides the optimum conditions for multiplication. Temporarily heating the water to above 60 °C kills off the legionella.

Room thermostat

A room thermostat continuously measures the room temperature and compares it with the room temperature you have set (target room temperature). This allows the heating system to maintain a constant set temperature in your room.

In addition, you can enter individual heating times. The target room temperature and the heating times set by you control the operation of your boiler, the power of which is adapted automatically to the respective heat demand.

Weather compensator

A weather compensator is a controller that controls the heating flow temperature of the heating system as a function of the measured outside temperature.

On the weather compensator you can also enter individual heating times. The outside temperatures measured and the heating times set control the operation of the burner, the output of which is adjusted automatically to the respective heat demand.

Index

A		H	
Air/flue gas duct	32	Heating flow temperature	15
B		Hot water production.....	5, 8, 14, 18, 32
Boiler anti-cycling time	11	Hot water temperature.....	6, 8, 15, 17
C		I	
CE label	3	Identification plate	3
Controller.....	10, 15, 16, 17, 18, 32	Ignition	24, 27
Controls.....	10	Intended use	5
Customer service.....	31	Isolator devices	13
D		L	
Decommissioning.....	30	Legionella protection function.....	17
Display	10, 14, 15, 19	M	
Disposal.....	30	Malfunction	23, 24
Domestic hot water		Must be reported	27
Drawing hot water.....	8	S	
Setting cylinder charging mode (VUW unit).....	16	Setting	
Setting the hot water temperature.....	15, 17	Setting the hot water temperature (VUW unit).....	16
Setting the temperature (VUW unit)	16	Setting cylinder charging mode (VUW unit).....	16
E		Status displays	22
Energy saving tips	20	Summer mode	18, 27
F		Switching off	
Fault codes	22	Boiler	19
Fault elimination	24	Hot water production	18
Filling	14	Switching off the boiler	19
Filling pressure.....	14	Switching on	
Filling the heating system	14	Boiler	13
Flue gas.....	6	Electricity supply.....	23
Flue gas smell.....	6	Frost protection function.....	19
Frost		Setting cylinder charging mode (VUW unit).....	16
Activating the frost protection function.....	19	Switching on the boiler	13
Draining the heating system.....	19	Symbols.....	3
Protecting the heating system against frost.....	19	Symbols used.....	3

Index

T

Temperature	
Setting the hot water temperature.....	15, 17
Setting the hot water temperature (VUW unit).....	16
Troubleshooting	22

V

Vaillant customer service	31
---------------------------------	----

W

Water shortage.....	23
---------------------	----

Brief operating instructions

For detailed information, please read the corresponding Section in these installation instructions.

1. Switching the heating mode off (summer mode) (→Section 5.6.2)

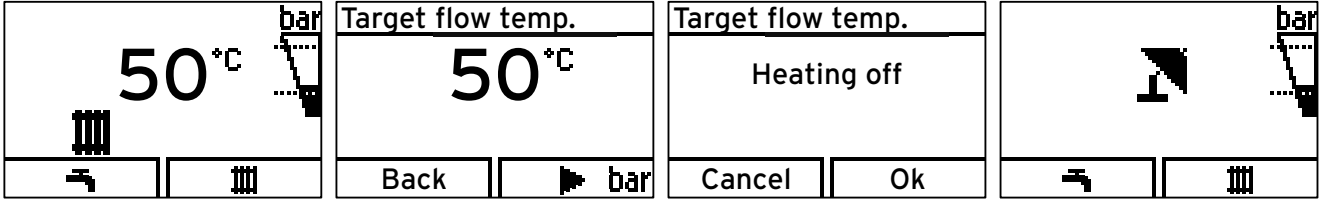

- > Right-hand selection button "→"
- > --Button to "Heating off"
- > Confirm "OK"

2. Setting the heating temperature (switching on Heating mode) (→ Section 5.2.1)

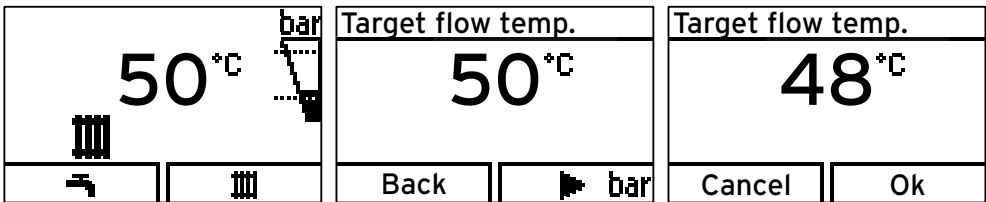

- > Right-hand selection button "→"
- > +/- button for selecting the temperature
- > Confirm "OK"

3. Setting the hot water temperature (→Section 5.3.1)

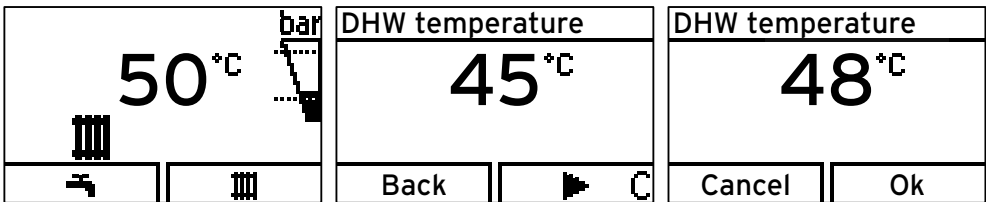

- > Left-hand selection button "←"
- > +/- button for selecting the temperature
- > Confirm "OK"

4. Switching Comfort mode on/off (→Section 5.3.2)

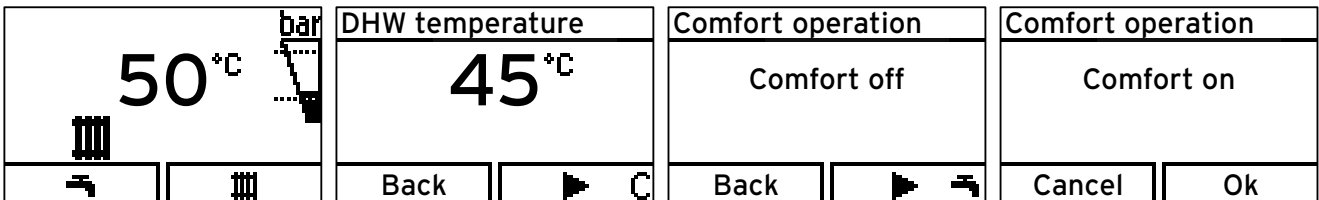

- > Left-hand selection button "←"
- > Right-hand selection button for Comfort mode
- > +/- button for switching on/off
- > Confirm "OK"

Supplier

Vaillant Ltd

Nottingham Road ■ Belper ■ Derbyshire ■ DE56 1JT

Telephone 0845 602 2922 ■ www.vaillant.co.uk ■ info@vaillant.co.uk

Manufacturer

Vaillant GmbH

Berghauser Str. 40 ■ D-42859 Remscheid ■ Telefon 0 21 91/18-0

Telefax 0 21 91/18-28 10 ■ www.vaillant.de ■ info@vaillant.de