

Service instructions

for heating engineers

VIESSMANN

Vitodens 200

Type **WB2A**, 8.8 to 26.0 kW

Gas fired wall mounted condensing boiler
natural gas and LPG version

See applicability on the last page



VITODENS 200



Safety instructions



Please follow these safety instructions closely to prevent accidents and material losses.

Safety instructions explained



Danger

This symbol warns against the risk of injury.



Important information

This symbol warns against the risk of material losses and environmental pollution.

Note

Details identified by the words "Note" contain additional information.

Warranty

All warranty rights are void if these service instructions are not observed.

Target group

These service instructions are exclusively designed for qualified personnel.

Work on gas equipment must only be carried out by a registered gas fitter. Only approved contractors may modify this equipment for countries other than those designated on the type plate. That contractor will then arrange for the relevant approval in that country.

Electrical work must only be carried out by a qualified electrician.

The system must be commissioned by the system installer or a qualified person authorised by the installer.

Regulations

Observe the following during service work:

- all legal instructions regarding the prevention of accidents,
- the TRGI, TRF and special regulations, e.g. those of the BDH, (A) ÖVGW-TR Gas, ÖVGW-TRF, (CH) SVGW,
- all legal instructions regarding environmental protection,
- the Code of Practice by relevant trade associations and all local regulations.

If you notice a smell of gas



Danger

Escaping gas can cause explosions which may lead to serious injury.

- Do not smoke. Prevent naked flames and sparks. Never switch electrical lights or equipment.
- Open windows and doors.
- Close the gas shut-off valve.
- Remove all personnel from the danger zone.
- Observe the safety regulations of your local gas supplier which can be found on the gas meter.
- Notify your heating contractor from outside the building.

Safety instructions (cont.)

If you smell flue gas



Danger

Flue gas may lead to life-threatening poisoning.

- Shut down the heating system.
- Ventilate the boiler room.
- Close all doors leading to living areas.

Repair work

It is not permitted to carry out repairs on parts that fulfil a safety function. Use only original Viessmann spare parts, or equivalent parts that have been approved by Viessmann.

Service work on the heating system

- Isolate the system from mains supply and check that it is no longer "live", e.g. by removing a separate fuse or by means of a mains electrical isolator.
- Safeguard the system against unauthorised reconnection.
- When using gas as fuel, also close the main gas shut-off valve and safeguard against unauthorised reopening.

Ancillary components, spare and wearing parts



Important information

Components which are not tested with the heating system, the installation of non-approved spare parts and unauthorised conversion may lead to damage to the heating system, which may affect their function and limit our warranty. For conversions or replacements, use only original parts from Viessmann or those spare parts which are approved by Viessmann.

| | |
|--|-----|
| Index | |
| Initial start-up, inspection, maintenance | |
| Steps - initial start-up, inspection and maintenance | 5 |
| Further details regarding the individual steps | 7 |
| Coding | |
| Code 1..... | 39 |
| Code 2..... | 42 |
| Resetting the coding to the as delivered condition | 62 |
| Service scans | |
| Service level summary..... | 63 |
| Temperatures, boiler coding card and brief scans | 64 |
| Checking outputs (relay test) | 68 |
| Scanning operating conditions and sensors | 69 |
| Troubleshooting | |
| Downloading fault codes history..... | 72 |
| Call up current fault codes | 72 |
| Checking and acknowledging faults | 74 |
| Repairs | 84 |
| Function description | |
| Constant temperature control unit | 96 |
| Weather-compensated control unit..... | 98 |
| Extensions for external connections (accessory)..... | 100 |
| Control functions | 104 |
| Designs | |
| Connection and wiring diagrams – internal connections..... | 109 |
| Connection and wiring diagrams – external connections..... | 111 |
| Parts lists | 113 |
| Commissioning/service reports | 120 |
| Specification | 126 |
| Certificates | |
| Declaration of conformity | 127 |
| Manufacturer's certificate according to the 1st BImSchV [Germany]..... | 128 |
| Keyword index | 129 |

Steps - initial start-up, inspection and maintenance

For further instructions on individual steps, see pages indicated

| | Page |
|--|------|
| <ul style="list-style-type: none"> • Commissioning steps • Inspection steps • Maintenance steps | |
| • 1. Filling the heating system | 7 |
| • 2. Venting the boiler | 9 |
| • 3. Venting the heating system | 9 |
| • 4. Filling the siphon with water | 10 |
| • 5. Checking the electrical mains connection | |
| • 6. Language selection (if required) - only for weather-compensated control units | 10 |
| • • 7. Setting the time and date (if required) - only for weather-compensated control units | 11 |
| • • 8. Checking the gas type | 11 |
| • • 9. Gas type conversion | 12 |
| • • • 10. Function sequence and possible faults | 12 |
| • • • 11. Checking static and supply pressure | 14 |
| • • • 12. Checking the CO ₂ settings | 16 |
| • • • 13. Setting the max. output | 18 |
| • • • 14. Check all connections on the primary and DHW side for leaks | |
| • • • 15. Checking the burner (recording values on page 120 of the commissioning report) | |
| • • • 16. Checking the balanced flue system for soundness (annular gap check) | 19 |
| • • • 17. Removing the burner and checking the burner gasket (replace gasket every two years) | 20 |
| • • • 18. Checking the burner gauze assembly | 21 |
| • • • 19. Checking and adjusting the ignition and ionisation electrodes | 22 |
| • • • 20. Cleaning the combustion chamber/cleaning the heating surfaces and installing the burner | 23 |

Further details regarding the individual steps

Filling the heating system

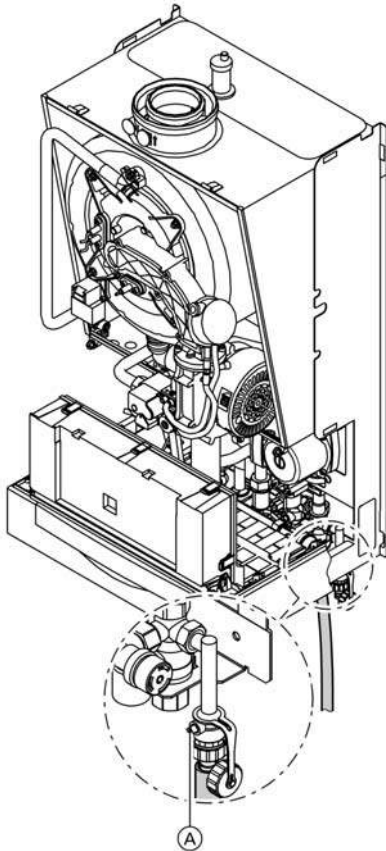

1. Check the charge pressure of the diaphragm expansion vessel.

2. Close the gas shut-off valve.

3. **!** **Important information**
- Unsuitable fill water increases the level of deposits and corrosion and may lead to boiler damage.
- Thoroughly flush the entire heating system prior to filling with water.
 - Only use fill water of potable quality.
 - Soften fill water harder than 20 °dH (3.58 mmol/l). For suitable means of water softening, see the Vitotec price list.
 - An anti-freeze additive suitable for heating systems can be mixed with the fill water.

Fill the heating system via the boiler fill & drain valve (A). (minimum system pressure > 0.8 bar).

Note

The diverter valve actuator will be in the central position, and the system will be completely filled, if the control unit has not been switched ON before the system was filled.

Initial start-up, inspection, maintenance

Further details regarding the individual steps (cont.)

4. If the control unit had already been switched ON before filling began: Start the control unit and in code 1, set coding address 2F:2. The diverter valve will then be in its central position.
5. Close the boiler fill & drain valve .
6. Set coding address 2F:0.

Note

To call up code 1 and for setting the coding address, see page 39.

Whilst filling is in progress, the display shows bF (constant temperature control unit) or "Filling" (weather-compensated control unit).

Continue filling the system.

Further details regarding the individual steps (cont.)

Venting the boiler

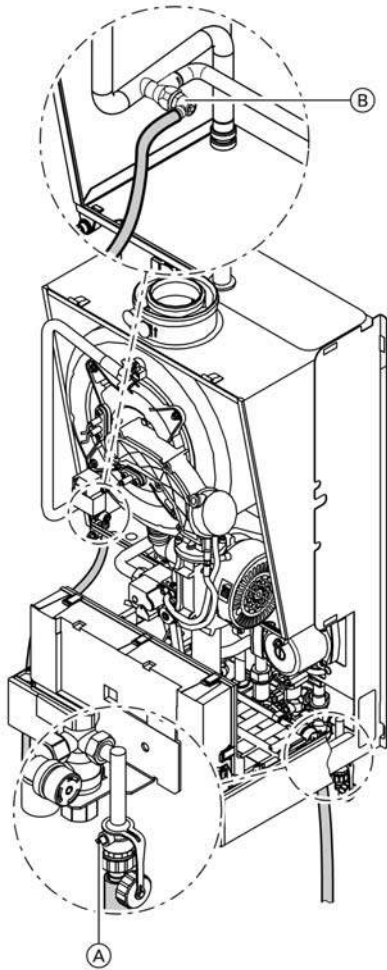

1. Close the shut-off valves on the heating water side.
2. Connect the drain hose on upper valve **(B)** with a drain outlet.
3. Open valves **(A)** and **(B)**, and vent at mains pressure, until no sound of escaping air can be heard.
4. Close valves **(A)** and **(B)**, and open the primary shut-off valves.

Venting the heating system

1. Close the gas shut-off valve and start the control unit.

Further details regarding the individual steps (cont.)

2. Activate the venting program via coding address 2F:1.
3. Check the system pressure.

Note

To call up code 1 and for setting the coding address, see page 39.
For function and sequence of the venting program, see page 105.
Whilst venting is in progress, the display shows EL (constant temperature control unit) or "Venting" (weather-compensated control unit).

Filling the siphon with water

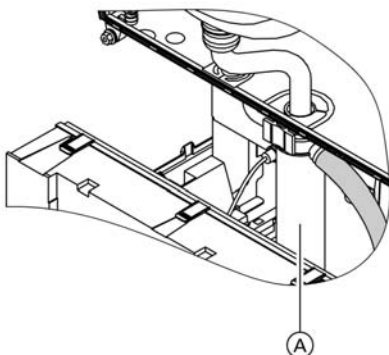

1. Remove the retaining clip and siphon (A).
2. Fill the siphon with water.
3. Fit siphon (A) and secure with the retaining clip.

Language selection (if required) - only for weather-compensated control units



1. Press (i).
The display shows "Select heating circuit".
2. Press (OK).
3. After approx. 4 seconds press (i).
4. Select the required language with (-).
5. Confirm with (OK).

Further details regarding the individual steps (cont.)

Setting the time and date (if required) - only for weather-compensated control units

Note

During commissioning, or after prolonged time out of use, it may be necessary to set the time and date.

1. Press .
2. Set the time with \oplus/\ominus .
3. Confirm with ; "Date" will be displayed.
4. Set the current date with \oplus/\ominus .
5. Confirm with .

Checking the gas type

1. Enquire about the gas type and Wobbe index (Wo) from your local mains gas or LPG supplier.
3. If these details do not match the fuel provided, the burner must be converted according to the details provided by the mains gas or the LPG supplier.

Note

In the as delivered condition, Vito-dens 200 is set up for natural gas E.

The boiler can be operated in the Wobbe index range 12.0 to 16.1 kWh/m³ (43.2 to 58.0 MJ/m³).

2. Compare the gas category (gas type) and gas group with the details on the burner label.



See separate conversion kit installation instructions.

After conversion to

■ Natural gas LL

The boiler can be operated in the Wobbe index range 10.0 to 13.1 kWh/m³ (36.0 to 47.2 MJ/m³).

■ LPG P

The boiler can be operated in the Wobbe index range 21.4 to 22.5 kWh/m³ (76.9 to 81.0 MJ/m³).

Initial start-up, inspection, maintenance

Further details regarding the individual steps (cont.)

4. Set the gas type via coding address 1E at the control unit.
5. Record the gas type in the service report on page 120.

Note

To call up code 1 and for setting the coding address, see page 39.

Gas type conversion



Gas restrictor installation instructions.

Gas restrictor allocation

| Gas type | | Int. \varnothing gas restrictor |
|------------------|----|-----------------------------------|
| ■ Natural gas E | mm | 6.2 |
| ■ Natural gas LL | mm | 8.1 |
| ■ LPG P | mm | 4.2 |

Function sequence and possible faults

For further details regarding faults, see page 72.

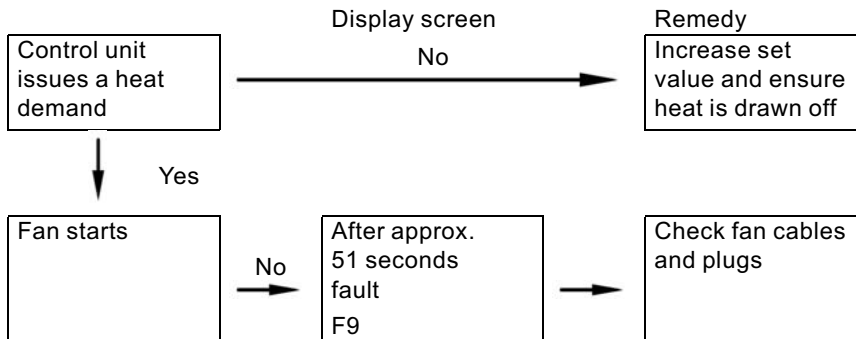

Further details regarding the individual steps (cont.)

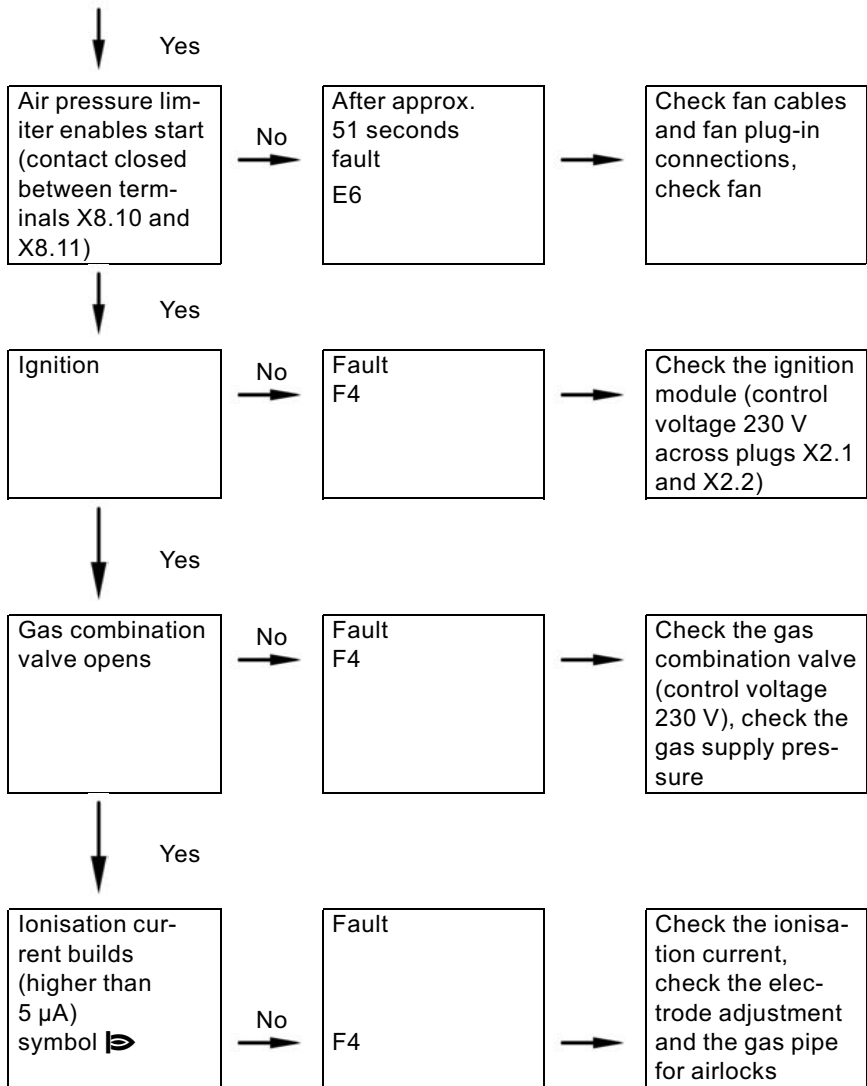

Initial start-up, inspection, maintenance

Further details regarding the individual steps (cont.)

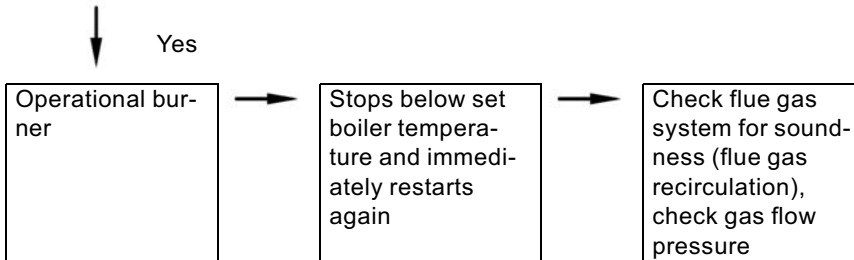

Checking static and supply pressure



Danger

Higher CO emissions can lead to poisoning.

Measure the CO value before and after any work on gas equipment to prevent any health hazards and to ensure the perfect operational condition of the system.

Operation with LPG

Flush the LPG tank twice during commissioning/replacement. Thoroughly vent the tank and gas lines after flushing.

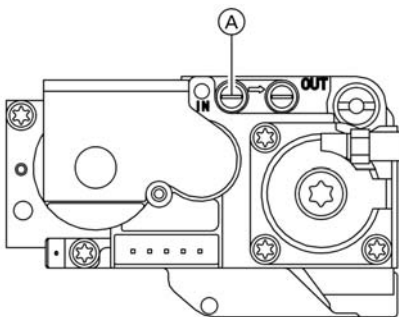

1. Close the gas shut-off valve.
2. Release the screw inside test nipple IN (A) on the gas combination valve, but do not remove, and connect the pressure gauge.
3. Open the gas shut-off valve.
4. Check the static pressure; it should be a max. of 57.5 mbar. Record the actual value in the service report.

Further details regarding the individual steps (cont.)

5. Start up boiler.

Note

During commissioning, the boiler can enter a fault state because of airlocks in the gas pipe. After approx. 5 seconds, press  to reset the burner.

6. Check the supply (flow) pressure; it should be

- 20 mbar for natural gas,
- and 50 mbar for LPG.

Note

Use suitable test equipment with a resolution of at least 0.1 mbar to measure the supply pressure.

Record the actual value in the service report.

Take the action shown in the table.

| Supply (flow) pressure for natural gas | Supply (flow) pressure for LPG | Remedy |
|--|--------------------------------|--|
| Below 17.4 mbar | Below 42.5 mbar | Do not start up. Notify your mains gas or LPG supplier. |
| 17.4 to 57.5 mbar | 42.5 to 57.5 mbar | Start up boiler. |
| In excess of 57.5 mbar | In excess of 57.5 mbar | Install a separate gas governor downstream of the system and regulate the pressure to 20 mbar for natural gas or 50 mbar for LPG. Notify your mains gas or LPG supplier. |

7. Shut down the boiler, close the gas shut-off valve, remove the pressure gauge, and close test nipple  with the screw.

Further details regarding the individual steps (cont.)

8.  **Danger**
Gas escaping from the test nipple leads to a risk of explosion.
Check for gas leaks.

Open the gas shut-off valve, start up the boiler and check soundness of test nipple (A).

Checking the CO₂ settings

Vitodens 200 is set up in the factory for natural gas E, and can be converted to natural gas LL or LPG P using a conversion kit.

During commissioning or maintenance, check the CO₂ level at the boiler adaptor.

Subject to the Wobbe index, the CO₂ content fluctuates between

- 7.4 to 10.5 % for natural gas E
- 7.8 to 10.5 % for natural gas LL and
- 8.5 to 11.0 % for LPG P.

Compare the actual CO₂ value with the above CO₂ value ranges for the individual gas groups (check the gas group with your mains gas or LPG supplier).

If the actual CO₂ value deviates by more than 1 % for natural gas or 0.5 % for LPG, proceed as follows:

- Check whether the correct gas restrictor has been installed.
- Check the balanced flue system for soundness, see page 19.

Further details regarding the individual steps (cont.)

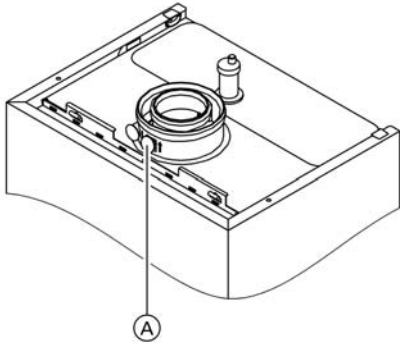

1. Connect a flue gas analyser at flue gas connector (A) on the flue outlet.
2. Open the gas shut-off valve, commission the boiler and create a heat demand.
3. Select the lower rated output.

Constant temperature control unit:

- Press both keys \odot and OK simultaneously until the display shows 1.

Weather-compensated control unit:

- Press both keys \odot and OK simultaneously until the display shows "Relay test".
- With \oplus/\ominus in the display, select "Basic load".

4. Check the CO₂ content. Should the actual value deviate by more than 1 % from the above range, implement steps from page 16 (possibly replace the burner).
5. Enter actual values into the service report.
6. Set the upper rated output.

Constant temperature control unit:

- With \oplus/\ominus in the display, select 2.

Weather-compensated control unit:

- With \oplus/\ominus in the display, select "Full load".







Further details regarding the individual steps (cont.)

7. Check the CO₂ content. Should the actual value deviate by more than 1 % from the above range, implement steps from page 16 (possibly replace the burner).
8. After testing, press .
9. Enter actual values into the service report.

Setting the max. output

Note

The max. output can be limited for **heating operation**. You can limit the output via the modulation range.

1. Start up the boiler.
2. Press  and  simultaneously until 85 flashes on the display (= rated output) and  appears. On weather-compensated control units the display additionally shows "Max. output".
3. With / select the required value in % of rated output as max. output.
4. Confirm the set value with .
5. Record the settings for max. output on the additional type plate included with the technical documentation. Affix the type plate next to the original type plate on top of the boiler.

Note

The output can also be limited for **DHW loading**. For this, change coding address 6F in code 2.

Further details regarding the individual steps (cont.)

Checking the balanced flue system for soundness (annular gap check)

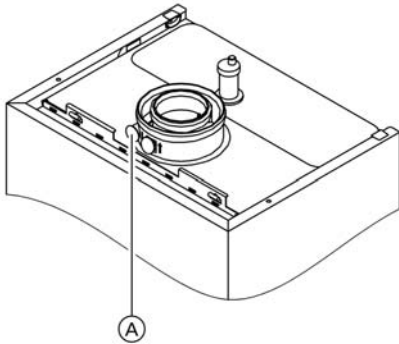

Ⓐ Combustion air aperture

For balanced flue systems tested together with gas fired wall mounted boilers, some Federal States (e.g. Nordrhein-Westphalia) waive the requirement for a soundness test (overpressure test) during commissioning by the flue gas inspector. For such cases we recommend that your heating contractor carries out a simple soundness test during the initial start-up of your system. For this, it would be sufficient to check the CO₂ concentration in the combustion air at the annular gap in the balanced flue pipe.

The flue pipe is deemed to be sound, if the CO₂ concentration of the combustion air is no higher than 0.2 % or the O₂ concentration is at least 20.6 %.

If actual CO₂ values are higher or O₂ values are lower, carry out a pressure test on the flue pipe at a static pressure of 200 Pa.

Further details regarding the individual steps (cont.)

**Removing the burner and checking the burner gasket
(replace gasket every two years)**

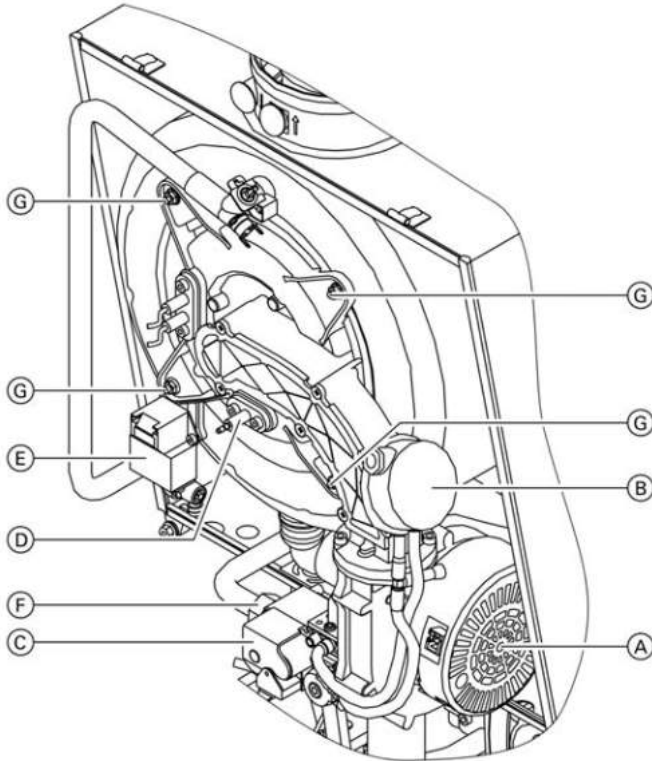

1. Switch OFF the control unit ON/OFF switch and the mains electrical supply.
2. Close the gas shut-off valve and safeguard against reopening.
3. Pull electrical cables from fan motor (A), pressure switch (B), gas valve (C), ionisation electrode (D) and ignition unit (E).

4. Release gas connection pipe (F).
5. Release four nuts (G), and remove the burner.

! **Important information**
To prevent damage,
never rest the burner on the
gauze assembly.

Further details regarding the individual steps (cont.)

6. Check the burner gasket for damage.
Generally, replace the burner gasket **every two years**.

Checking the burner gauze assembly

Replace the burner gauze assembly if it is damaged.

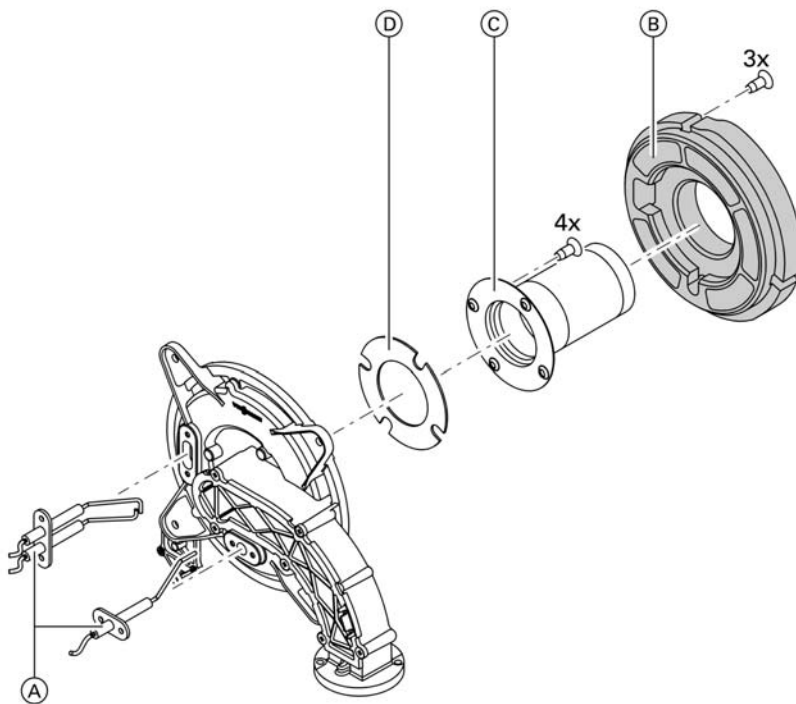

1. Remove electrodes (A).
2. Release the three Torx screws, and remove thermal insulating ring (B).
3. Release the four Torx screws, and remove burner gauze assembly (C) with its gasket (D).
4. Insert and secure a new burner gauze assembly (C) with a new gasket (D).
Torque: 3.5 Nm.
5. Refit the thermal insulation ring (B).

Initial start-up, inspection, maintenance

Further details regarding the individual steps (cont.)

6. Refit the electrodes (A).
Torque: 2.5 Nm.

Checking and adjusting the ignition and ionisation electrodes

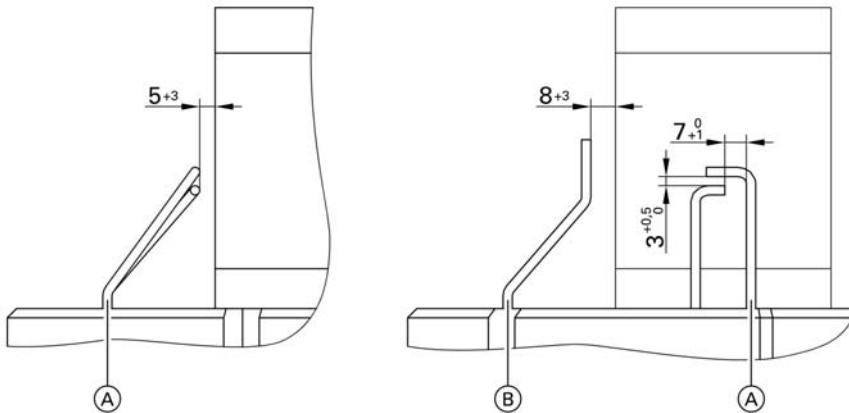

(A) Ignition electrodes

1. Check the electrodes for wear and contamination.
2. Clean the electrodes with a small brush (not with a wire brush) or emery paper.

(B) Ionisation electrode

3. Check all clearances. If the gaps are not as specified or the electrodes are damaged, replace and align the electrodes together with new gaskets. Tighten the electrode fixing screws with 2.5 Nm.

Further details regarding the individual steps (cont.)

Cleaning the combustion chamber/cleaning the heating surfaces and installing the burner

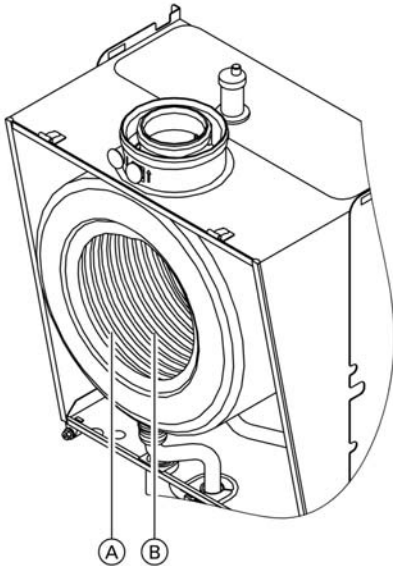

1. If required, clean combustion chamber (A) and heating surfaces (B) with a brush, or flush with water.

! **Important information**
Scratches on parts which are in contact with flue gases, can lead to corrosion. Only use plastic brushes and NOT wire brushes.

Apply a solvent-/potassium-free cleaning agent if residues remain:

- Remove soot deposits with alkaline cleaning agents with additional surfactants (e.g. Fauch 600).
- Remove coatings and surface discolouration (yellow-brown) with slightly acidic, chloride-free cleaning agents based on phosphoric acid (e.g. Antox 75 E).
- Thoroughly flush with water.

Note

Fauch 600 and Antox 75 E are supplied by

Hebro Chemie GmbH

Rostocker Straße 40

D 41199 Mönchengladbach

☎: Intec Bassersdorf AG

Grindelstrasse 12

Postfach

CH-8303 Bassersdorf

2. Install the burner and torque screws diagonally with 4 Nm.

Further details regarding the individual steps (cont.)

3. Secure the gas supply pipe with a new gasket.
4. Check the gas connections for soundness.



Danger

Escaping gas leads to a risk of explosion.
Check all fittings for soundness.

5. Connect the electrical cables/leads to each corresponding component.

Checking the condensate drain and cleaning the siphon

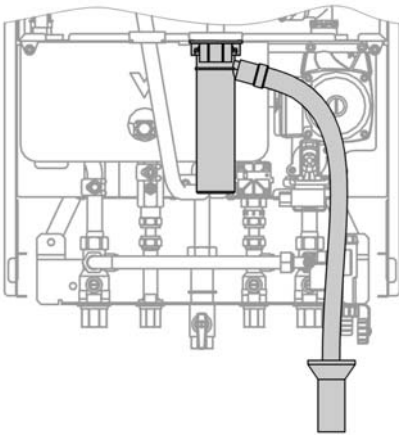

1. Check at the siphon, that the condensate can drain freely.
2. Remove the retaining clip and the siphon.
3. Clean the siphon.
4. Fill the siphon with water, fit it to the boiler and secure with the retaining clip.

Further details regarding the individual steps (cont.)

Flow limiter (only for gas combination boilers)

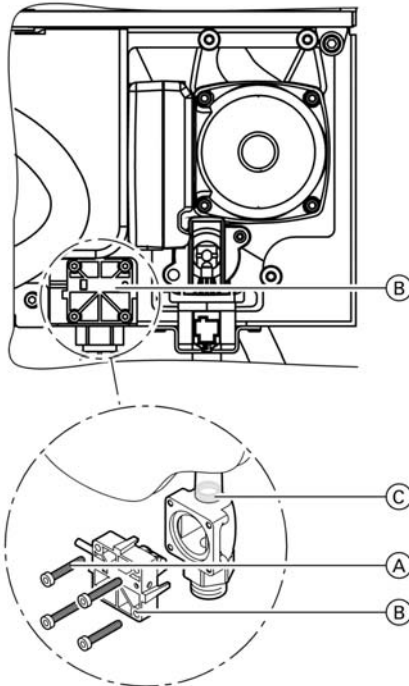

1. Switch OFF the control unit, shut off the cold water supply line and drain the secondary (DHW) side of the boiler.

2. Release the Allen screws (A).

Note

Residual water may escape during dismantling.

3. Remove flow switch (B) and remove flow limiter (C) downwards.

4. Check flow limiter (C); replace in case of excessive calcination or damage.

Secure flow switch (B).

Checking all gas equipment for soundness at operating pressure



Danger

Escaping gas leads to a risk of explosion.

Check gas equipment for soundness.

Further details regarding the individual steps (cont.)

Checking the ionisation current

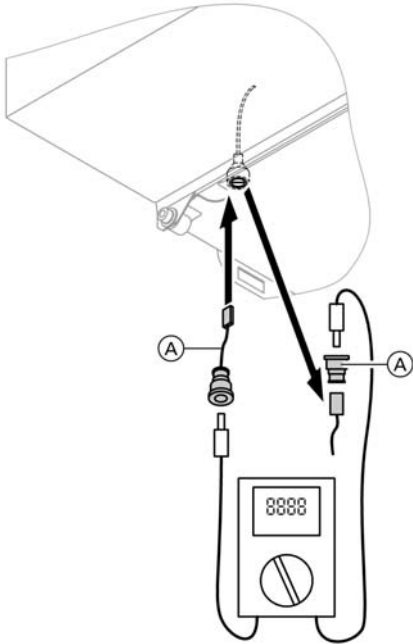

(A) Adaptor line (available as accessory)

1. Pull the line off and connect test equipment (adaptor line available as accessory).

2. Set the upper rated output.

Constant temperature control unit:

- Press \square and OK simultaneously for a minimum of 2 seconds.
- With \oplus/\ominus in the display, select 2.

Weather-compensated control unit:

- Press \square and OK simultaneously for a minimum of 2 seconds.
- With \oplus/\ominus in the display, select "Full load".

Note

The minimum ionisation current should be at least $4 \mu\text{A}$ as soon as the flame is established (approx. 2 - 3 seconds after opening the gas combination valve).

3. If the ionisation current is $< 4 \mu\text{A}$

- Check the electrode gap, see page 22.
- Check the control unit power supply.

4. After testing, press OK .

5. Record the actual value in the service report.

Further details regarding the individual steps (cont.)

Matching the control unit to the heating system

Note

The control unit must be matched to the system equipment. Various system components are automatically recognised by the control unit, and codes are automatically set.

In the following system designs, DHW loading is illustrated with a separate DHW cylinder. The designs also apply to systems where DHW is heated by an integral instantaneous water heater. In that case, the cylinder temperature sensor [5] is factory fitted to the boiler.

- For selection of an appropriate design, see the following diagrams.
- For coding steps, see page 39.

System design 1

With/without DHW loading/heating with one heating circuit without mixer A1

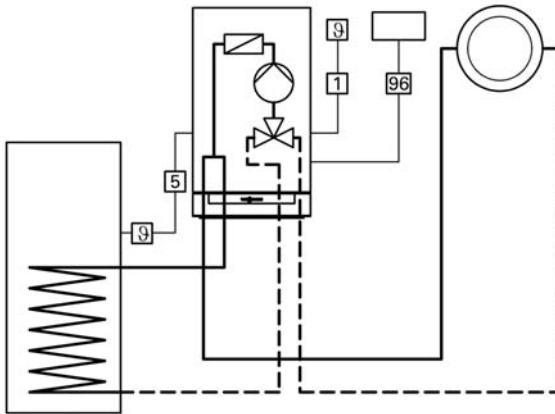

- [1] Outside temperature sensor (only for weather-compensated control units) or
- [96] Vitotrol 100 (only for constant temperature control units)
- [5] Cylinder temperature sensor

5692.573 GB

| Required coding | Address |
|---|---------|
| Operation with natural gas (as delivered condition) or | 1E:0 |

Initial start-up, inspection, maintenance

Further details regarding the individual steps (cont.)

| Required coding | Address |
|--------------------|---------|
| Operation with LPG | 1E:1 |

System design 2

With/without DHW heating with one heating circuit without mixer A1 and one heating circuit with mixer M2

Note

The volume flow of the heating circuit without mixer must be at least 30 % greater than the volume flow of the heating circuit with mixer.

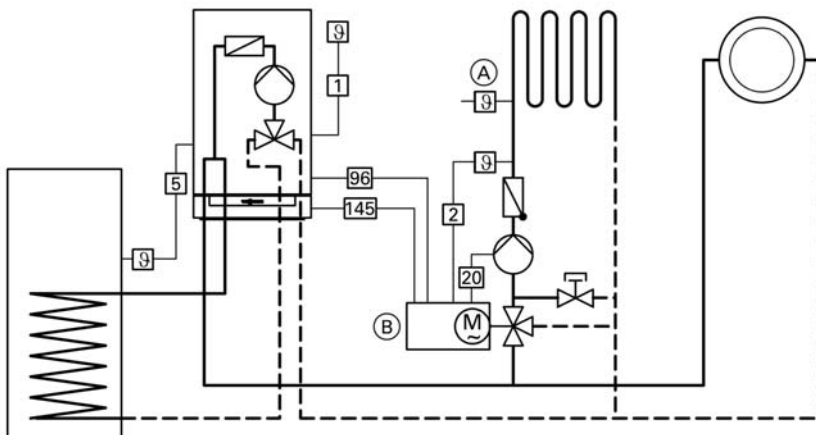

- | | | | |
|----|------------------------------|-----|---|
| 1 | Outside temperature sensor | 145 | KM BUS |
| 2 | Flow temperature sensor | (A) | Maximum temperature controller (underfloor heating) |
| 5 | Cylinder temperature sensor | (B) | Extension kit for one heating circuit with mixer |
| 20 | Heating circuit pump | | |
| 96 | Mains supply (extension kit) | | |

| Required coding | Address |
|---|---------|
| Operation with natural gas (as delivered condition) | 1E:0 |
| or | |
| Operation with LPG | 1E:1 |
| System with only one heating circuit with mixer | |
| ■ with DHW cylinder | 00:4 |
| ■ without DHW cylinder | 00:3 |

5692.573 GB

Further details regarding the individual steps (cont.)

System design 3

With/without DHW heating with one heating circuit without mixer A1 and one heating circuit with mixer M2 and system separation

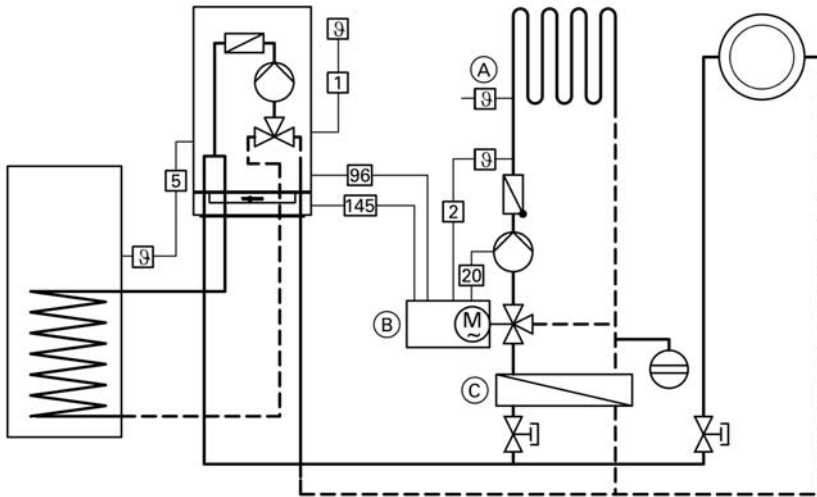

- | | |
|--|---|
| <ul style="list-style-type: none"> 1 Outside temperature sensor 2 Flow temperature sensor 5 Cylinder temperature sensor 20 Heating circuit pump 96 Mains supply (extension kit) 145 KM BUS | <ul style="list-style-type: none"> (A) Maximum temperature controller (underfloor heating) (B) Extension kit for one heating circuit with mixer (C) Heat exchanger for system separation |
|--|---|

| Required coding | Address |
|---|------------------|
| Operation with natural gas (as delivered condition) or Operation with LPG | 1E:0 1E:1 |

System design 4

With/without DHW heating with one heating circuit with mixer M2 (with extension kit), one heating circuit with mixer (Vitoltronic 050) and low loss header

5692.573 GB

Initial start-up, inspection, maintenance

Further details regarding the individual steps (cont.)

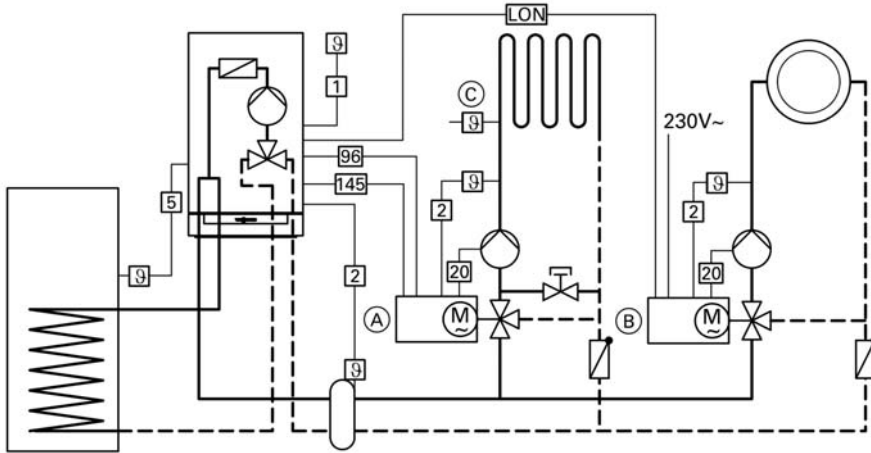

- | | | | |
|-----|------------------------------|-----|---|
| 1 | Outside temperature sensor | (A) | Extension kit for one heating circuit with mixer |
| 2 | Flow temperature sensor | (B) | Vitotronic 050 |
| 5 | Cylinder temperature sensor | (C) | Maximum temperature controller (underfloor heating) |
| 20 | Heating circuit pump | | |
| 96 | Mains supply (extension kit) | | |
| 145 | KM BUS | | |

| Required coding | Address |
|--|---------|
| One heating circuit with mixer with extension kit for mixer and one heating circuit with mixer with Vitotronic 050 | |
| ■ with DHW cylinder | 00:4 |
| ■ without DHW cylinder | 00:3 |
| Operation with natural gas (as delivered condition) | 1E:0 |
| or | |
| Operation with LPG | 1E:1 |

System design 5

With one heating circuit without mixer A1, solar panels and Vitocell-W 100 DHW cylinder (type CVB) installed adjacent to the boiler

Further details regarding the individual steps (cont.)

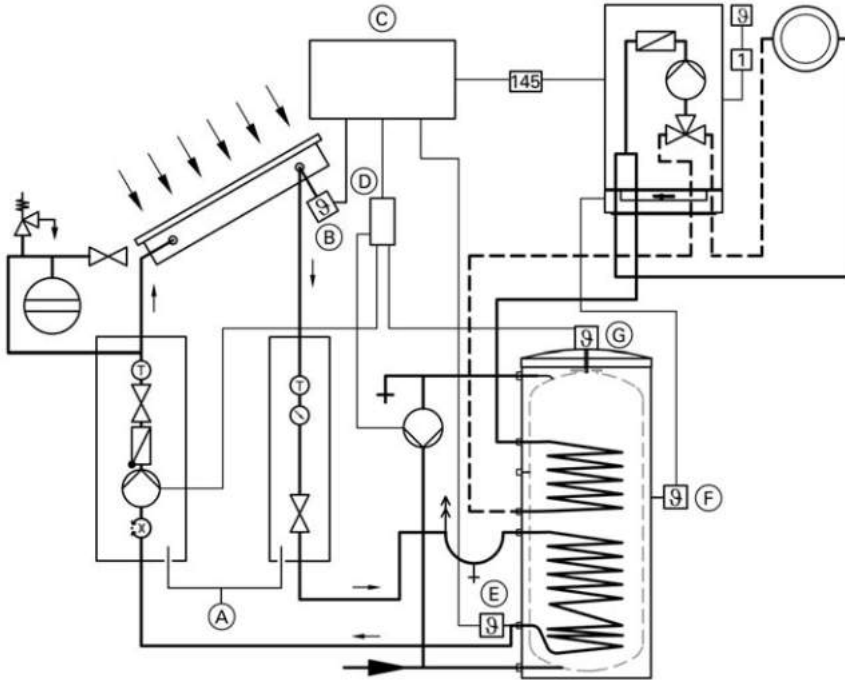

- | | | | |
|-----|--|---|---|
| 1 | Outside temperature sensor | E | Cylinder temperature sensor for solar operation |
| 145 | KM BUS | F | Cylinder temperature sensor (accessory) |
| A | Solar-Divicon | G | High limit safety cut-out* ¹ |
| B | Collector temperature sensor | | |
| C | Vitosolic 100 or 200 | | |
| D | Connection extension (only for Vitosolic 100, accessory) | | |

| Required coding | Address |
|---|--------------|
| 3. Set DHW temperature at 40 °C (check as delivered condition) | 67:40 |
| Operation with natural gas (as delivered condition) or Operation with LPG | 1E:0 1E:1 |

5692 573 GB

*¹High limit safety cut-out required only for:

DHW volume smaller than 30 litres/m² absorber surface when using Vitosol 100.

DHW volume smaller than 100 litres/m² absorber surface when using Vitosol 200 or 300.

Initial start-up, inspection, maintenance

Further details regarding the individual steps (cont.)

Connecting the control unit to the LON system (only for weather-compensated control units)

The LON communication module (accessory) must be plugged in.



Installation instructions
for LON communication module

Note

Data transfer via the LON system can take 2 to 3 minutes.



Setting up LON user numbers

Adjust the user number via coding address 77 (see below).

In a LON system, the same number **cannot** be allocated twice.

Updating the LON user list

Only possible, if all users are connected, and the control unit is encoded as fault manager (code 79:1).

1. Press  and  simultaneously for approx. 2 seconds. User check initiated (see page 33).
2. Press . The user list is updated after approx. 2 minutes. User check completed.

Single boiler system with Vitotronic 050 and Vitocom 300

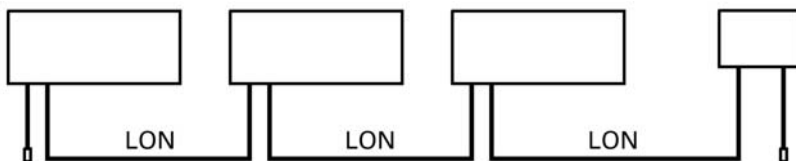

| Boiler control unit | Vitotronic 050 | Vitotronic 050 | Vitocom |
|---|---|--|-------------------------------|
| User no. 1 Code 77:1 | User no. 10 Code 77:10 | User no. 11 Set code 77:11 | User no. 99 |
| Control unit is fault manager *1 Code 79:1 | Control unit is not fault manager *1 Code 79:0 | Control unit is not fault manager*1 Code 79:0 | Control unit is fault manager |

*1 In each heating system, **only one Vitotronic** may be encoded as fault manager.

5692 573 GB

Further details regarding the individual steps (cont.)

| Boiler control unit | Vitotronic 050 | Vitotronic 050 | Vitocom |
|---|--|--|-----------------------|
| Sent time via LON Code 7b:1 | Time received via LON Set code 81:3 | Time received via LON Set code 81:3 | Time received via LON |
| Transmit outside temperature via LON Set code 97:2 | Outside temperature is received via LON Set code 97:1 | Outside temperature is received via LON Set code 97:1 | — |

Implementing a user check (in conjunction with the LON system)

The communication with the system devices connected to the fault manager is tested with a user check.

Preconditions:

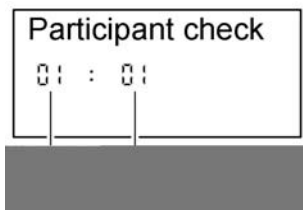

- The control unit must be encoded as fault manager (code 79:1).
- The LON user number must be encoded in all control units (see page 32).
- The fault manager user list must be up to date (see page 32).



- (A) Consecutive list number
- (B) User number

1. Press and simultaneously for approx. 2 seconds. User check initiated.
2. Select the required user with and .
3. Activate checking with . "Check" flashes until its completion. The display and all key illuminations of the selected user flash for approx. 60 seconds.
 - "Check OK" flashes during communication between both devices.
 - "Check not OK" flashes if there is no communication between both devices. Check LON connection.
4. For checking further users, proceed as for items 2 and 3.

Further details regarding the individual steps (cont.)

5. Press  and  simultaneously for approx. 1 second. User check completed.

Adjusting heating curves (only for weather-compensated control units)

The heating curves illustrate the relationship between the outside temperature and the boiler water or the flow temperature. To put it simply: The lower the outside temperature, the higher the boiler water or flow temperature. The room temperature, again, depends on the boiler water or the flow temperature.

Settings in the delivered condition:

- Slope = 1.4
- Level = 0

Generally, the slope of the heating curve lies

- in the range of (A) for underfloor heating systems,
- in the range of (B) for low temperature heating systems (according to the Energy Savings Order [Germany]).

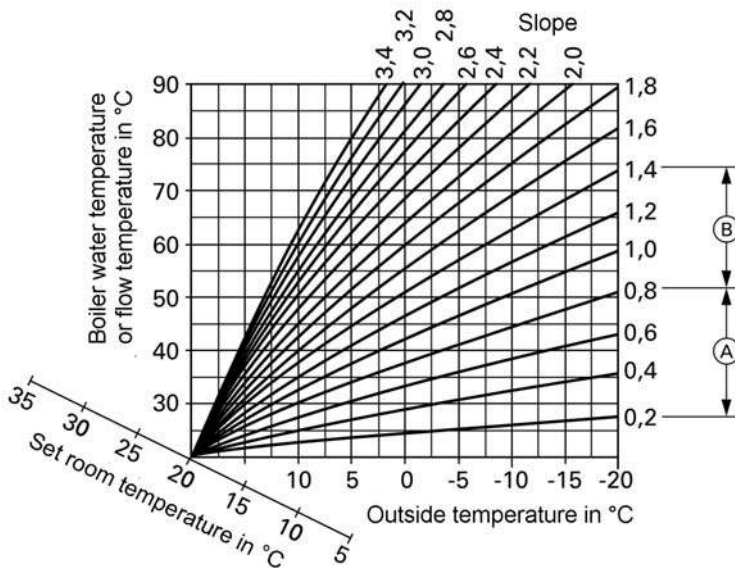

Further details regarding the individual steps (cont.)

Changing slope and level

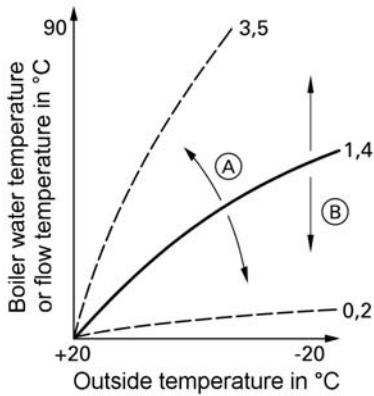

- (A) Changing the slope
- (B) Changing the level

1. Modify the slope in code 1 with coding address d3 (see page 39). Adjustable value 2 to 35 (equals slope 0.2 to 3.5).
2. Modify the slope in code 1 with coding address d4 (see page 39). Value adjustable from -13 to +40 K.

Adjusting the set room temperature

Standard room temperature:

1. For two heating circuits – select heating circuit:
 - Press \oplus .
 - 1 \blacksquare flashes on the display.
 - Select heating circuit A1 (heating circuit without mixer):
Press \otimes .
 - Select heating circuit M2 (heating circuit with mixer):
 - Press \oplus .
 - 2 \blacksquare flashes on the display.
 - Press \otimes .

Further details regarding the individual steps (cont.)

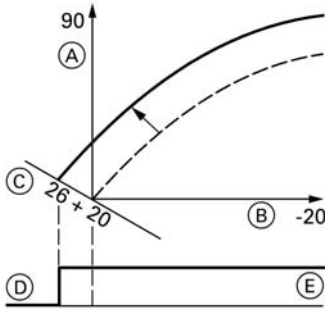



2. Adjust the set day temperature with rotary selector .

The value will be automatically adopted after approx. 2 seconds. Accordingly, the heating curve is adjusted along set room temperature axis **C**, which results in modified start/shutdown characteristics of the heating circuit pumps, if the heating circuit pump logic is activated.

Example 1: Modifying the standard room temperature from 20 °C to 26 °C

- A** Boiler water or flow temperature in °C
- B** Outside temperature in °C
- C** Set room temperature in °C
- D** Heating circuit pump OFF
- E** Heating circuit pump ON

Reduced room temperature:

1. For two heating circuits – select heating circuit:
 - Press **+**.
 - 1  flashes on the display.
 - Select heating circuit A1 (heating circuit without mixer):
Press **OK**.
 - Select heating circuit M2 (heating circuit with mixer):
 - Press **+**.
 - 2  flashes on the display.
 - Press **OK**.

Further details regarding the individual steps (cont.)

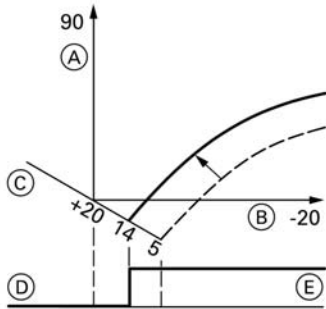

2. Call up the set night temperature with .
3. Change this value with \oplus and \ominus .
4. Confirm the set value with $\textcircled{\text{OK}}$.

Example 2: Modifying the reduced room temperature from 5 °C to 14 °C

- $\textcircled{\text{A}}$ Boiler water or flow temperature in °C
- $\textcircled{\text{B}}$ Outside temperature in °C
- $\textcircled{\text{C}}$ Set room temperature in °C
- $\textcircled{\text{D}}$ Heating circuit pump OFF
- $\textcircled{\text{E}}$ Heating circuit pump ON

Instructing the system user

The system installer must hand the operating instructions to the system user and instruct them in the operation of the system.

Scanning and resetting the "Maintenance" display

The red fault indicator flashes when the limits set via coding address 21 and 23 have been reached. As regards the operating interface display:

- for constant temperature control units, the hours run (subject to setting) or the given time interval and the clock symbol will flash,
- for weather-compensated control units "Maintenance" flashes.

Note

Set code 24:1 and then code 24:0, if maintenance is implemented before it is displayed; the set maintenance parameters for hours run and intervals are then reset to 0.

Initial start-up, inspection, maintenance

Further details regarding the individual steps (cont.)

1. Press **i**.
Maintenance scan is activated.
2. Scan maintenance messages with **+** or **-**.
3. Press **OK**, for weather-compensated control units, also confirm the display "Acknowledge: Yes" with **OK**.
"Maintenance" is cancelled from the display, and the red fault indicator continues to flash.

Note

*An acknowledged maintenance message can be redisplayed by pressing **OK** (approx. 3 seconds).*

After maintenance has been carried out

1. Reset code 24:1 to 24:0
The red fault indicator is extinguished.







Note

If coding address 24 is not reset, a new "Maintenance" message will be displayed on Monday at 07:00 h.

2. If required:
 - Press **i**.
 - Reset burner hours run, burner starts and consumption (see page 69).
 - Press **i**.

Code 1

Calling up code 1

1. Press  and  simultaneously for approx. 2 seconds.
2. Select the required coding address with \oplus or \ominus ; the address flashes. Confirm with ; the value flashes.
3. Change this value with \oplus and \ominus ; confirm with . The display briefly shows "adopted", then the address flashes again. Select additional addresses (if required) with \oplus or \ominus .
4. Press  and  simultaneously for approx. 1 second. Coding is terminated.

Note

Codes are displayed in plain text on weather-compensated control units. Codes, which are not relevant because of the equipment level of your heating system or because of settings of other codes will not be displayed.

Coding

Code 1 (cont.)

Summary

Codes

| Coding in the as delivered condition Address: value | Function mode | Coding change Address: value | Possible change |
|---|---|------------------------------------|---|
| System design | | | |
| 00:1 | System design 1: 1 heating circuit without mixer A1, without DHW heating | 00:2 | System design 1, 5: 1 heating circuit without mixer A1, with DHW heating |
| | | 00:3 | System design 4: 1 mixer circuit M2, without DHW heating |
| | | 00:4 | System design 4: 1 mixer circuit M2, with DHW heating |
| | | 00:5 | System design 2, 3: 1 heating circuit without mixer A1 and 1 mixer circuit M2, without DHW heating |
| | | 00:6 | System design 2, 3: 1 heating circuit without mixer A1, 1 mixer circuit M2 with DHW heating |
| Max. boiler temp. | | | |
| 06:... | Maximum limit of the boiler water temperature, defaulted by the boiler coding card. | 06:20 to 06:127 | Maximum limit of the boiler water limit within the ranges defaulted by the boiler. |
| Gas type | | | |
| 1E:0 | Operation with natural gas | 1E:1 | Operation with LPG |
| Venting/filling | | | |
| 2F:0 | Ventilation program/filling program inactive | 2F:1 | Venting program active |
| | | 2F:2 | Filling program active |

5692 573 GB

Code 1 (cont.)

| Coding in the as delivered condition Address: value | Function mode | Coding change Address: value | Possible change |
|--|---|-------------------------------------|--|
| User no. | | | |
| 77:1 | LON user number | 77:2 to 77:99 | LON user number, adjustable from 1 to 99: 1 - 4 = boiler 5 = cascade 10 - ... = Vitotronic 050 99 = Vitocom Note <i>Allocate each number only once</i> |
| Summer econ. A1 | | | |
| A5:5 | * ¹ With heating circuit pump logic function | A5:0 | Without heating circuit pump logic function |
| Summer econ. M2 | | | |
| A5:5 | * ¹ With heating circuit pump logic function | A5:0 | Without heating circuit pump logic function |
| Min. flow temp. A1 | | | |
| C5:20 | Electronic minimum flow temperature limit 20 °C | C5:1 to C5:127 | Minimum limit adjustable from 1 to 127 °C |
| Min. flow temp. M2 | | | |
| C5:20 | Electronic minimum flow temperature limit 20 °C | C5:1 to C5:127 | Minimum limit adjustable from 1 to 127 °C |
| Max. flow temp. A1 | | | |
| C6:75 | * ¹ Electronic maximum flow temperature limit at 75 °C | C6:1 to C6:127 | Maximum limit adjustable from 1 to 127 °C |
| Max. flow temp. M2 | | | |
| C6:75 | * ¹ Electronic maximum flow temperature limit at 75 °C | C6:1 to C6:127 | Maximum limit adjustable from 1 to 127 °C |













Coding

Code 1 (cont.)

| Coding in the as delivered condition Address: value | Function mode | Coding change Address: value | Possible change |
|---|--------------------------------|------------------------------------|--|
| Slope A1 | | | |
| d3:14 | *1Heating curve slope = 1.4 | d3:2 to d3:35 | Heating curve slope adjustable from 0.2 to 3.3 (see page 34) |
| Slope M2 | | | |
| d3:14 | *1Heating curve slope = 1.4 | d3:2 to d3:35 | Heating curve slope adjustable from 0.2 to 3.3 (see page 34) |
| Level A1 | | | |
| d4:0 | *1Heating curve level = 0 | d4:-13 to d4:40 | Heating curve level adjustable from -13 to 40 (see page 34) |
| Level M2 | | | |
| d4:0 | *1Heating curve level = 0 | d4:-13 to d4:40 | Heating curve level adjustable from -13 to 40 (see page 34) |

Code 2

Calling up code 2

- Press  and  simultaneously for approx. 2 seconds; confirm with .
- Select the required coding address with  or ; the address flashes. Confirm with ; the value flashes.
- Change this value with  and ; confirm with . The display briefly shows "adopted", then the address flashes again. Select additional addresses (if required) with  or .
- Press  and  simultaneously for approx. 1 second. Coding is terminated.

*1 Only for weather-compensated control units

Code 2 (cont.)**Overall summary**

The coding addresses are grouped in accordance with the following **function ranges**. The respective function range is displayed.

Scroll through the ranges in the following sequence with ⊕ or ⊖.

| Function range | Coding addresses |
|---|-------------------------|
| System design | 00 |
| Boiler/burner | 06 to 54 |
| DHW | 56 to 73 |
| General | 76 to 9F |
| Boiler circuit (heating circuit A1 without mixer) | A0 to F7 |
| Mixer circuit (heating circuit M2 with mixer) | A0 to F7 |

Code 2 (cont.)**Codes**

| Coding in the as delivered condition Address: value | Function mode | Coding change Address: value | Possible change |
|--|--|---|---|
| System design | | | |
| 00:1 | System design 1: 1 heating circuit without mixer A1, without DHW heating | 00:2 | System design 1, 5: 1 heating circuit without mixer A1, with DHW heating |
| | | 00:3 | System design 4: 1 mixer circuit M2, without DHW heating |
| | | 00:4 | System design 4: 1 mixer circuit M2, with DHW heating |
| | | 00:5 | System design 2, 3: 1 heating circuit without mixer A1 and 1 mixer circuit M2, without DHW heating |
| | | 00:6 | System design 2, 3: 1 heating circuit without mixer A1, 1 mixer circuit M2 with DHW heating |
| Boiler/burner | | | |
| 06:... | Maximum limit of the boiler water temperature, defaulted by the boiler coding card | 06:20 to 06:... | Maximum limit of the boiler water temperature within the ranges defaulted by the boiler |
| 1E:0 | Operation with natural gas | 1E:1 | Operation with LPG |
| 21:0 | No maintenance indication for the burner | 21:1 to 21:100 | The number of hours run before the burner should be serviced is adjustable from 100 to 10000 hours (each step represents 100 hours) |

Code 2 (cont.)

| Coding in the as delivered condition Address: value | Function mode | Coding change Address: value | Possible change |
|--|---|-------------------------------------|---|
| 23:0 | No time interval for burner maintenance | 23:1 to 23:24 | Time interval adjustable from 1 to 24 months |
| 24:0 | No "Maintenance" display | 24:1 | "Maintenance" display (the address is automatically set and must be manually reset after maintenance has been completed). |
| 25:0 | *1No recognition of outside temperature sensor or remote monitoring (only in ①). | 25:1 | Recognition of outside temperature sensor and fault monitoring |
| 28:0 | No burner interval ignition | 28:1 | The burner is forced ON once every 24 hours |
| 2E:0 | Without external extension | 2E:1 | Including external extension (automatical adjustment on connection) |
| 2F:0 | Ventilation program/filling program inactive | 2F:1 | Venting program active |
| | | 2F:2 | Filling program active |
| 30:0 | Internal non-variable speed circulation pump (automatic adjustment) | 30:1 | Internal variable speed circulation pump (e.g. temporarily for service) |
| 32:0 | Influence of "External lockout" signal on circulation pumps: All pumps are controlled | 32:1 to 32:15 | Influence of "External lockout" signal on circulation pumps: see the following table |

| Coding | Internal circulation pump | Heating circuit pump Heating circuit without mixer | Heating circuit pump Heating circuit with mixer | Cylinder loading pump |
|---------------|----------------------------------|---|--|------------------------------|
| 0 | Control funct. | Control funct. | Control funct. | Control funct. |

5692 573 GB

*1Only for constant temperature control units.

Coding

Code 2 (cont.)

| Coding | Internal circulation pump | Heating circuit pump Heating circuit without mixer | Heating circuit pump Heating circuit with mixer | Cylinder loading pump |
|---------------|----------------------------------|---|--|------------------------------|
| 1 | Control funct. | Control funct. | Control funct. | OFF |
| 2 | Control funct. | Control funct. | OFF | Control funct. |
| 3 | Control funct. | Control funct. | OFF | OFF |
| 4 | Control funct. | OFF | Control funct. | Control funct. |
| 5 | Control funct. | OFF | Control funct. | OFF |
| 6 | Control funct. | OFF | OFF | Control funct. |
| 7 | Control funct. | OFF | OFF | OFF |
| 8 | OFF | Control funct. | Control funct. | Control funct. |
| 9 | OFF | Control funct. | Control funct. | OFF |
| 10 | OFF | Control funct. | OFF | Control funct. |
| 11 | OFF | Control funct. | OFF | OFF |
| 12 | OFF | OFF | Control funct. | Control funct. |
| 13 | OFF | OFF | Control funct. | OFF |
| 14 | OFF | OFF | OFF | Control funct. |
| 15 | OFF | OFF | OFF | OFF |

| Coding in the as delivered condition Address: value | Function mode | Coding change Address: value | Possible change |
|--|--|-------------------------------------|---|
| Boiler/burner | | | |
| 34:0 | Influence of "External demand" signal on circulation pumps: All pumps are controlled | 34:1 to 34:23 | Influence of "External demand" signal on circulation pumps: See the following table |

5692 573 GB

Code 2 (cont.)

| Coding | Internal circulation pump | Heating circuit pump Heating circuit without mixer | Heating circuit pump Heating circuit with mixer | Cylinder loading pump |
|---------------|----------------------------------|---|--|------------------------------|
| 0 | Control funct. | Control funct. | Control funct. | Control funct. |
| 1 | Control funct. | Control funct. | Control funct. | OFF |
| 2 | Control funct. | Control funct. | OFF | Control funct. |
| 3 | Control funct. | Control funct. | OFF | OFF |
| 4 | Control funct. | OFF | Control funct. | Control funct. |
| 5 | Control funct. | OFF | Control funct. | OFF |
| 6 | Control funct. | OFF | OFF | Control funct. |
| 7 | Control funct. | OFF | OFF | OFF |
| 8 | OFF | Control funct. | Control funct. | Control funct. |
| 9 | OFF | Control funct. | Control funct. | OFF |
| 10 | OFF | Control funct. | OFF | Control funct. |
| 11 | OFF | Control funct. | OFF | OFF |
| 12 | OFF | OFF | Control funct. | Control funct. |
| 13 | OFF | OFF | Control funct. | OFF |
| 14 | OFF | OFF | OFF | Control funct. |
| 15 | OFF | OFF | OFF | OFF |
| 16 | ON | Control funct. | Control funct. | Control funct. |
| 17 | ON | Control funct. | Control funct. | OFF |
| 18 | ON | Control funct. | OFF | Control funct. |
| 19 | ON | Control funct. | OFF | OFF |
| 20 | ON | OFF | Control funct. | Control funct. |

Coding

Code 2 (cont.)

| Coding | Internal circulation pump | Heating circuit pump Heating circuit without mixer | Heating circuit pump Heating circuit with mixer | Cylinder loading pump |
|---------------|----------------------------------|---|--|------------------------------|
| 21 | ON | OFF | Control funct. | OFF |
| 22 | ON | OFF | OFF | Control funct. |
| 23 | ON | OFF | OFF | OFF |

| Coding in the as delivered condition Address: value | Function mode | Coding change Address: value | Possible change |
|--|--|-------------------------------------|--|
| Boiler/burner | | | |
| 38:0 | Burner control unit state (0 = burner control unit OK) | 38:... | Do not adjust |
| 52:0 | Without flow temperature sensor for low loss header | 52:1 | With flow temperature sensor for low loss header (automatic adjustment upon recognition) |
| 53:1 | Function connection 28 of the internal extension: DHW circulation pump | 53:0 | Function connection 28: Central fault |
| | | 53:2 | Function connection 28: External heating circuit pump (heating circuit A1) |
| | | 53:3 | Function relay 2: External cylinder loading pump |
| 54:0 | Without solar control unit | 54:1 | With Vitosolic 100 |
| | | 54:2 | With Vitosolic 200 (automatic adjustment on recognition) |

Code 2 (cont.)

| Coding in the as delivered condition Address: value | Function mode | Coding change Address: value | Possible change |
|--|---|---|---|
| Domestic hot water | | | |
| 56:0 | DHW temperature adjustable from 10 to 60 °C | 56:1 | DHW temperature adjustable from 10 to above 60 °C (subject to boiler coding card; only for gas fired boilers) Observe the max. permissible DHW temperature |
| 58:0 | Without auxiliary function for DHW loading | 58:1 to 58:95 | Input of a set DHW value 2; adjustable from 1 to 95 °C (observe coding address 56) |
| 59:0 | DHW cylinder loading: Starting point -2.5 K Stopping point +2.5 K | 59:1 to 59:10 | Starting point adjustable from 1 to 10 K below the set value |
| 5B:0 | DHW cylinder directly connected to the boiler | 5B:1 | DHW cylinder connected downstream of the low loss header |
| 60:20 | During DHW loading, the boiler water temperature is max. 20 K higher than set DHW temperature | 60:5 to 60:25 | The difference between the boiler water temperature and the set DHW temperature is adjustable from 10 to 50 K |
| 62:2 | Circulation pump with 2 minutes run-on time | 62:0 | Circulation pump without run-on |
| | | 62:1 to 62:15 | Run-on time adjustable from 1 to 15 minutes |
| 63:0 | *1Without auxiliary function for DHW loading | 63:1 | Additional function: 1 x daily |
| | | 63:2 to 63:14 | every 2 to every 14 days |
| | | 63:15 | 2 x daily |

Coding

Code 2 (cont.)

| Coding in the as delivered condition Address: value | Function mode | Coding change Address: value | Possible change |
|--|---|---|---|
| 65:... | Information regarding the type of diverter valve (not adjustable) | 65:0 | Without diverter valve |
| | | 65:1 | Diverter valve by Viessmann |
| | | 65:2 | Diverter valve by Wilo |
| | | 65:3 | Diverter valve by Grundfos |
| 67:40 | In conjunction with Vitosolic solar control unit: Set DHW value 3 | 67:0 to 67:60 | DHW set value adjustable from 0 to 60 °C |
| 6F:100 | Max. output during DHW loading 100 %, defaulted by the boiler coding card | 6F:0 to 6F:100 | Max. output during DHW loading adjustable from 0 to 100 % |
| 71:0 | *1DHW circulation pump: ON according to time program (Vitol 300 enables separate switching times) | 71:1 | OFF during DHW loading to set value 1 |
| | | 71:2 | ON during DHW loading to set value 1 |
| 72:0 | *1DHW circulation pump: ON according to time program | 72:1 | OFF during DHW loading to set value 2 |
| | | 72:2 | ON during DHW loading to set value 2 |
| 73:0 | *1DHW circulation pump: ON according to time program | 73:1 to 73:6 | During the time program 1x/h ON for 5 minutes up to 6x/h ON for 5 minutes |
| | | 73:7 | Constantly ON |
| | | General | |
| 76:0 | Without LON communication module | 76:1 | With LON communication module; automatic recognition |

*1Only for weather-compensated control units

Code 2 (cont.)

| Coding in the as delivered condition Address: value | Function mode | Coding change Address: value | Possible change |
|---|---|------------------------------------|---|
| 77:1 | *1LON user number | 77:2 to 77:99 | LON user number, adjustable from 1 to 99: 1 - 4 = boiler 5 = cascade 10 - ... = Vitotronic 050 99 = Vitocom Note <i>Allocate each number only once</i> |
| 79:1 | *1Control unit is fault manager | 79:0 | Control unit is not fault manager |
| 7b:1 | *1Send time to LON | 7b:0 | Do not send time to LON |
| 7F:1 | *1Detached house | 7F:0 | Multi-occupancy house: Separate adjustment for holiday program and time program for DHW loading, as option |
| 80:1 | With 5 seconds time delay for fault message; message will be issued, if a fault persists for at least 5 seconds | 80:0 | Without time delay |
| | | 80:2 to 80:199 | Time delay adjustable from 10 s to 995; 1 step = 5 s |
| 81:1 | Automatic summer/winter changeover | 81:0 | Manual summer/winter changeover |
| | | 81:2 | The application of the radio clock module will be recognised automatically |
| | | 81:3 | Accept time via LON |
| 88:0 | Temperature display in °Celsius | 88:1 | Temperature display in Fahrenheit |
| 8A:175 | Do not adjust | | |

Code 2 (cont.)

| Coding in the as delivered condition Address: value | Function mode | Coding change Address: value | Possible change |
|--|---|-------------------------------------|--|
| 90:128 | Time constant for calculating adjusted outside temperature 21.3 h | 90:0 to 90:199 | Quick (low values) or slow (high values) matching of flow temperature subject to set value if the outside temperature changes; 1 step = 10 min. |
| 91:0 | *1No external operating mode changeover via external extension | 91:1 | External heating program changeover affects heating circuit without mixer |
| | | 91:2 | External heating program changeover affects heating circuit with mixer |
| | | 91:3 | External heating program changeover applies to heating circuit without mixer and heating circuit with mixer |
| 95:0 | Without Vitocom 100 communication interface | 95:1 | With Vitocom 100 communication interface; automatic recognition |
| 97:0 | *1The outside temperature of the sensor connected to the control unit is utilised internally | 97:1 | Outside temperature is adopted by the LON BUS |
| | | 97:2 | The outside temperature of the sensor connected to the control unit will be utilised internally and transmitted via LON BUS to any connected Vitotronic 050. |
| 98:1 | Viessmann system numbers (in conjunction with monitoring of several systems via Vitocom 300). | 98:1 to 98:5 | System number adjustable from 1 to 5 |

*1Only for weather-compensated control units

Code 2 (cont.)

| Coding in the as delivered condition Address: value | Function mode | Coding change Address: value | Possible change |
|--|---|-------------------------------------|--|
| 9b:0 | No minimum set boiler water temperature in case of external demand | 9b:1 to 9b:127 | Set temperature adjustable from 1 to 127 °C |
| 9C:20 | *1Monitoring LON users: When there is no response from a user, values defaulted inside the control unit continue to be used for a further 20 minutes. Only then will a fault message be triggered. | 9C:0 | No monitoring |
| | | 9C:5 to 9C:60 | Time adjustable from 5 to 60 minutes |
| 9F:8 | *1Differential temperature 8 K; only in conjunction with a mixer circuit | 9F:0 to 9F:40 | Differential temperature adjustable from 0 to 40 K |
| Boiler circuit, mixer circuit | | | |
| A0:0 | *1Without remote control | A0:1 | With Vitotrol 200 (automatic recognition) |
| | | A0:2 | With Vitotrol 300 (automatic recognition) |

Code 2 (cont.)

| Coding in the as delivered condition Address: value | Function mode | Coding change Address: value | Possible change |
|---|--|------------------------------------|--|
| A3:5 | <p>*1Outside temperature below 4 °C: Heating circuit pump ON Outside temperature above 6 °C: Heating circuit pump OFF</p> <p>Note <i>With settings below 1 °C there is a risk of pipes outside the thermal insulation envelope of the house freezing-up. The standby mode, in particular, should be observed, e.g. during holidays.</i></p> | A3:-9 to A3:15 | Heating circuit pump ON/ OFF (see the following table). |

| Parameters Address A3:... | Heating circuit pump | |
|------------------------------|----------------------|--------|
| | ON at | OFF at |
| -9 | -10 °C | -8 °C |
| -8 | -9 °C | -7 °C |
| -7 | -8 °C | -6 °C |
| -6 | -7 °C | -5 °C |
| -5 | -6 °C | -4 °C |
| -4 | -5 °C | -3 °C |
| -3 | -4 °C | -2 °C |
| -2 | -3 °C | -1 °C |
| -1 | -2 °C | 0 °C |
| 0 | -1 °C | 1 °C |
| 1 | 0 °C | 2 °C |
| 2 | 1 °C | 3 °C |
| to | to | |
| 15 | 14 °C | 16 °C |

*1Only for weather-compensated control units

Code 2 (cont.)

| Coding in the as delivered condition Address: value | Function mode | Coding change Address: value | Possible change |
|--|---|-------------------------------------|--|
| Boiler circuit, mixer circuit | | | |
| A4:0 | * ¹ With frost protection | A4:1 | No frost protection, adjustment only possible if code "A3:-9" is selected. Note <i>With settings below 1 °C there is a risk of pipes outside the thermal insulation envelope of the house freezing-up. The standby mode, in particular, should be observed, e.g. during holidays.</i> |
| A5:5 | * ¹ With heating circuit pump logic function (economy circuit): Heating circuit pump OFF, if the outside temperature (AT) is 1 K higher than the set room temperature (RT _{Set}) AT > RT _{Set} + 1 K | A5:0 | Without heating circuit pump logic function |
| | | A5:1 to A5:15 | With heating circuit pump logic function: Heating circuit pump OFF, if (see the following table) |

| Parameter address A5:... | With heating circuit pump logic function: Heating circuit pump OFF, if |
|---------------------------------|---|
| 1 | AT > RT _{Set} + 5 K |
| 2 | AT > RT _{Set} + 4 K |
| 3 | AT > RT _{Set} + 3 K |
| 4 | AT > RT _{Set} + 2 K |
| 5 | AT > RT _{Set} + 1 K |
| 6 | AT > RT _{Set} |

*¹Only for weather-compensated control units

Coding

Code 2 (cont.)

| | |
|-------------------------------------|---|
| Parameter address A5:... | With heating circuit pump logic function: Heating circuit pump OFF, if |
| 7 | AT > RT _{Set} - 1 K |
| to | |
| 15 | AT > RT _{Set} - 9 K |

| Coding in the as delivered condition Address: value | Function mode | Coding change Address: value | Possible change |
|--|--|---|--|
| Boiler circuit, mixer circuit | | | |
| A6:36 | *1Extended economy circuit inactive | A6:5 to A6:35 | Extended economy circuit active, i.e. the burner and heating circuit pump will be switched OFF, and the mixer will be closed at a variable value, which is adjustable between 5 and 35 °C plus 1 °C. This value is based on the adjusted outside temperature, comprising the actual outside temperature and a time constant, which takes the cooling down of an average building into consideration. |

*1Only for weather-compensated control units

Code 2 (cont.)

| Coding in the as delivered condition Address: value | Function mode | Coding change Address: value | Possible change |
|---|---|------------------------------------|---|
| A7:0 | * ¹ Without mixer economy function | A7:1 | With mixer economy function (extended heating circuit pump logic): Heating circuit pump also OFF, if the mixer was closed for longer than 20 minutes. Heating pump ON, <ul style="list-style-type: none"> ■ if the mixer changes to control mode or ■ after cylinder loading (for 20 minutes) or ■ if there is a risk of frost |
| A8:1 | * ¹ Heating circuit M2 (mixer circuit) creates a demand for the internal circulation pump | A8:0 | Heating circuit M2 (mixer circuit) creates no demand for the internal circulation pump |
| A9:7 | * ¹ With pump idle time: Heating circuit pump OFF in case of set value modification (by changing the operating mode or changing the set room temperature). | A9:0 | * ¹ Without pump idle time |
| | | A9:1 to A9:15 | With pump idle time, adjustable from 1 to 15 |

Code 2 (cont.)

| Coding in the as delivered condition Address: value | Function mode | Coding change Address: value | Possible change |
|--|---|-------------------------------------|--|
| b0:0 | *1With remote control: Heating mode/reduced mode: Weather-compensated.*2 | b0:1 | Heating mode: Weather-compensated Reduced mode: With room temperature hook-up |
| | | b0:2 | Heating mode: With room temperature hook-up Reduced mode: Weather-compensated |
| | | b0:3 | Heating mode/reduced mode: With room temperature hook-up |
| b2:8 | With remote control unit and for the heating circuit, heating with room temperature hook-up must be encoded: Room influence factor 8.*2 | b2:0 | Without room influence |
| | | b2:1 to b2:64 | Room influence factor adjustable from 1 to 64 |
| b5:0 | *1With remote control: Without room temperature dependent heating circuit pump logic function.*2 | b5:1 to b5:8 | Heating circuit pump logic function - see the following table. |

| Parameter address b5:... | With heating circuit pump logic function: Heating circuit pump OFF, if |
|---------------------------------|--|
| 1: | active $RT_{Actual} > RT_{Set} + 5 \text{ K}$; passive $RT_{Actual} < RT_{Set} + 4 \text{ K}$ |
| 2: | active $RT_{Actual} > RT_{Set} + 4 \text{ K}$; passive $RT_{Actual} < RT_{Set} + 3 \text{ K}$ |
| 3: | active $RT_{Actual} > RT_{Set} + 3 \text{ K}$; passive $RT_{Actual} < RT_{Set} + 2 \text{ K}$ |
| 4: | active $RT_{Actual} > RT_{Set} + 2 \text{ K}$; passive $RT_{Actual} < RT_{Set} + 1 \text{ K}$ |
| 5: | active $RT_{Actual} > RT_{Set} + 1 \text{ K}$; passive $RT_{Actual} < RT_{Set}$ |
| 6: | active $RT_{Actual} > RT_{Set}$; passive $RT_{Actual} < RT_{Set} - 1 \text{ K}$ |

*1Only for weather-compensated control units

*2Change the coding for the heating circuit without mixer A1 or for mixer circuit M2, if the remote control unit affects that heating circuit.

Code 2 (cont.)

| Parameter address b5:... | With heating circuit pump logic function: Heating circuit pump OFF, if |
|--------------------------|--|
| 7: | active $RT_{Actual} > RT_{Set} - 1 \text{ K}$; passive $RT_{Actual} < RT_{Set} - 2 \text{ K}$ |
| 8: | active $RT_{Actual} > RT_{Set} - 2 \text{ K}$; passive $RT_{Actual} < RT_{Set} - 3 \text{ K}$ |

| Coding in the as delivered condition Address: value | Function mode | Coding change Address: value | Possible change |
|---|---|------------------------------|--|
| Boiler circuit, mixer circuit | | | |
| C5:20 | *1Electronic minimum flow temperature limit in standard mode 20 °C | C5:1 to C5:127 | Minimum temperature limit in standard mode adjustable from 1 to 127 °C |
| C6:74 | *1Electronic maximum flow temperature limit 74 °C | C6:0 to C6:127 | Maximum temperature limit adjustable from 1 to 127 °C |
| d3:14 | *1Heating curve slope = 1.4 | d3:2 to d3:35 | Heating curve slope adjustable from 0.2 to 3.5 (see page 34) |
| d4:0 | *1Heating curve level = 0 | d4:-13 to d4:40 | Heating curve level adjustable from -13 to 40 (see page 34) |
| d5:0 | *1The external operating mode changeover changes the heating program to "Constant operation with reduced room temperature". | d5:1 | The external operating mode changeover changes the heating program to "Constant operation with standard room temperature". |
| E1:1 | *1With remote control: Set day value is adjustable at the remote control unit from 10 to 30 °C | E1:0 | Set day value adjustable from 3 to 23 °C |
| | | E1:2 | Set day value adjustable from 17 to 37 °C |
| E2:50 | *1With remote control unit and for the heating circuit, heating with room temperature hook-up must be encoded: | E2:0 to E2:49 | Display correction - 5 K or display correction - 0.1 K |
| | | E2:51 to | Display correction +0.1 K or |
| | | | |

Code 2 (cont.)

| Coding in the as delivered condition Address: value | Function mode | Coding change Address: value | Possible change |
|--|---|---|---|
| | No display correction of the actual room temperature. | E2:99 | display correction +4.9 K |
| Mixer circuit | | | |
| F1:0 | Screed function inactive (only for weather-compensated control units) | F1:1 to F1:5 | <p>Screed drying function adjustable in accordance with 5 optional temperature time profiles (see page 106).</p> <p>Note <i>Observe the screed drying supplier's instructions.</i></p> <p>Observe DIN 4725-2 or local regulations. The report to be provided by the heating contractor must contain the following heat-up details:</p> <ul style="list-style-type: none"> ■ Heat-up data with respective flow temperatures ■ Max. flow temperature achieved ■ Operating condition and outside temperature during handover <p>The function continues after power failure or after the control unit has been switched OFF. The  heating program will be started after the screed-drying function has been completed, or if</p> |

Code 2 (cont.)

| Coding in the as delivered condition Address: value | Function mode | Coding change Address: value | Possible change |
|---|---|------------------------------------|--|
| | | | the address is manually set to 0. |
| | | F1:6 to F1:15 | Constant flow temperature 20 °C |
| F2:8 | *2Time limit for party operation 8 hours or external operating mode changeover via push button*3 | F2:0 | No time limit for party mode |
| | | F2:1 to F2:12 | Time limit adjustable from 1 to 12 hours*3 |
| F5:12 | *4Run-on time of the internal circulation pump in heating mode | F5:0 | No run-on time of the internal circulation pump |
| | | F5:1 to F5:20 | Run-on time of the internal circulation pump adjustable from 1 to 20 minutes |
| F6:0 | *4In the "DHW only" operating mode, the internal circulation pump is permanently OFF | F6:1 to F6:24 | In the "DHW only" operating mode, the internal circulation pump will be started 1 to 24 times per day for 10 minutes, respectively |
| | | F6:25 | In the "DHW only" operating mode, the internal circulation pump is permanently ON |
| F7:10 | *4In "Standby mode", the internal circulation pump will be started 10 times per day for 10 minutes respectively | F7:0 | In "Standby mode", the internal circulation pump is permanently OFF |
| | | F7:1 to F7:24 | In "Standby mode", the internal circulation pump will be started 1 to 24 times per day for |

*2Only for weather-compensated control units

*3In heating program III , the party mode ends **automatically** when changing over to operation with standard room temperature.







*4Only for constant temperature control units.

Coding

Code 2 (cont.)







































| Coding in the as delivered condition Address: value | Function mode | Coding change Address: value | Possible change |
|---|---------------|------------------------------------|--|
| | | F7:25 | 10 minutes respectively. * ⁵ Internal circulation pump is permanently ON in "Standby mode" |

Resetting the coding to the as delivered condition

1. Press  and  simultaneously for approx. 2 seconds.
2. Press .
"Basic setting? Yes" with .
With  or , you can select "Basic setting? Yes" or "Basic setting? No".





*⁵Only for constant temperature control units.

Service level summary

| Function | Key combination | Exit | Page |
|---|--|--|------|
| Temperatures, boiler coding card and brief scans | Press  and  simultaneously for approx. 2 seconds | Press  | 64 |
| Relay test | Press  and  simultaneously for approx. 2 seconds | Press  | 68 |
| Max. output (heating mode) | Press  and  simultaneously for approx. 2 seconds | Press  | 18 |
| Operating condition | Press  | Press  | 69 |
| Maintenance scan |  (if "Maintenance" flashes) | Press  | 37 |
| Adjusting the display contrast | Press  and  simultaneously; display darkens | – | – |
| | Press  and  simultaneously; display becomes lighter | – | – |
| Error history | Press  and  simultaneously for approx. 2 seconds | – | – |
| User check (in conjunction with LON system) | Press  and  simultaneously for approx. 2 seconds | – | – |
| Emissions test function  | Press  and  simultaneously for approx. 2 seconds | Press  and  simultaneously | – |
| Coding level 1 Plain text display | Press  and  simultaneously for approx. 2 seconds | Press  and  simultaneously | 39 |
| Coding level 2 Numerical display | Press  and  simultaneously for approx. 2 seconds | Press  and  simultaneously | 42 |
| Max. output in heating mode | Press  and  simultaneously for approx. 2 seconds | Press  and  simultaneously | 18 |

Temperatures, boiler coding card and brief scans

Weather-compensated control unit







1. Press  and  simultaneously for approx. 2 seconds.
2. Select the required scan with  and .
3. Press .

The following values can be scanned, subject to the actual equipment level:

- Slope A1 – Level A1
- Slope M2 – Level M2
- Adj. outside temp.
- Actual outside temp.
- Set boiler temp.
- Actual boiler temp.
- Set DHW temp.
- Actual DHW temp.
- Actual DHW outlet temp.
- Set DHW outlet temp.
- Set flow temp.
- Actual flow temp.
- Set mixed flow temp.
- Actual mixed flow temp.
- Boiler coding card
- Brief scan 1
to
Brief scan 8

The adjusted outside temperature can be reset to the current outside temperature with .

Heating circuit with mixer
Heating circuit with mixer
Low loss header
Low loss header

| | Display screen | | | | | |
|--------------------|---|---|---|---|---|---|
| Brief scan |  |  |  |  |  |  |
| Boiler coding card | N/A | N/A | X | X | X | X |
| 1 | Software version Control unit | | Version Boiler (EEPROM) | | Version Burner control unit (EEPROM) | |
| 2 | System design 1 to 6 Display according to the relevant design | | Display KM BUS users | Max. demand temperature | | |

Temperatures, boiler coding card and brief scans (cont.)

| Display screen | | | | | | |
|----------------|---|---|--|--|--|------------------------------------|
| Brief scan | 0 | 0 | 0 | 0 | 0 | 0 |
| 3 | Flow switch position | Software version Programming unit | Software version Mixer extension kit | Software version Solar control unit | Software version LON system | Software version Ext. extension |
| 4 | Software version Burner control unit | | Type Burner control unit | | Boiler type | |
| 5 | 0: No ext. demand or operating mode change-over 1: Ext. demand or operating mode change-over present | 0: No ext. blocking 1: Ext. blocking present | N/A | External hook-up 0 to 10 V Display in % | | |
| 6 | Number of LON users | | Software version Third party controller | Max. output Display in % | | |
| | | | Heating circuit 1 (boiler circuit A1) | | Heating circuit 2 (mixer circuit M2) | |
| 7 | N/A | N/A | Remote control 0: excl. 1: Vitotrol 200 2: Vitotrol 300 | Software version Remote control | Remote control 0: excl. 1: Vitotrol 200 2: Vitotrol 300 | Software version Remote control |

Service scans

Temperatures, boiler coding card and brief scans (cont.)

| | Display screen | | | | | |
|-------------------|---|---|---|---|---|---|
| Brief scan | | | | | | |
| | Internal circulation pump | | Heating circuit pump boiler circuit A1 | | Heating circuit pump mixer circuit M2 | |
| 8 | Variable speed pump 0: excl. 1: Wilo 2: Grundfos | Software version Variable speed pump | Variable speed pump 0: excl. 1: Wilo 2: Grundfos | Software version Variable speed pump | Variable speed pump 0: excl. 1: Wilo 2: Grundfos | Software version Variable speed pump |

Constant temperature control unit

1. Press and simultaneously for approx. 2 seconds.
Scanning is active.
 2. Select the required scan with and .
 3. Press .
- Scanning is completed.

| | Display screen | | | | |
|-------------------|---------------------------------|--|----------------------------------|------------------------------------|------------------------------------|
| Brief scan | | | | | |
| 0 | Flow switch position | System design, display according to the design | Software version Control unit | | Software version User interface |
| 1 | Software version Solar panel | Software version Burner control unit | | Software version Ext. extension | Software version Cascade module |





Temperatures, boiler coding card and brief scans (cont.)

| | | Display screen | | | | |
|------------|---|---|---|---|---|--|
| Brief scan | 0 | 0 | 0 | 0 | 0 | |
| E | 0: No ext. demand or operating mode change-over 1: Ext. demand or operating mode change-over present | 0: No ext. blocking 1: Ext. blocking present | External hook-up 0 to 10 V Display in % | | | |
| 3 | | | Set boiler temperature at the boiler temperature sensor | | | |
| A | | | Highest demand temperature | | | |
| 4 | | | Burner control unit type | Boiler type | | |
| 5 | | | Set cylinder temperature at the cylinder temperature sensor (current value) | | | |
| b | | | Max. output in % | | | |
| C | | Boiler coding card (hexa-decimal) | | | | |
| c | | Version Equipment (EEPROM) | | Version Burner control unit (EEPROM) | | |
| d | | | | Variable speed pump 0: excl. 1: Wilo 2: Grundfos | Software version Variable speed pump | |

Service scans

Checking outputs (relay test)





Weather-compensated control unit

1. Press  and  simultaneously for approx. 2 seconds.
Relay test is activated.
 2. Select the relay outputs with  and .
 3. Press .
- Relay test is completed.

Subject to the actual equipment level, the following relay outputs can be controlled:

| Display | Description |
|--------------------------|---|
| Basic load | Burner modulation - lower output |
| Full load | Burner modulation - upper output |
| Heating valve | Diverter valve set to heating mode |
| Valve central pos. | Changeover valve in central position (fill) |
| DHW valve | Diverter valve set to DHW mode |
| Internal pump ON | Internal pump / output 20 ON |
| Close mixer | Mixer extension |
| Open mixer | Mixer extension |
| Heating circ. pump M2 ON | Mixer extension |
| Output int. | Internal extension |
| Heating circ. pump A1 ON | External extension |
| Cylinder loading pump ON | External extension |
| DHW circ. pump ON | External extension |
| Central fault display ON | External extension |
| Solar pump ON | Vitosolic |

Constant temperature control unit

1. Press  and  simultaneously for approx. 2 seconds.
Relay test is activated.
 2. Select the relay outputs with  and .
 3. Press .
- Relay test is completed.

Subject to the actual equipment level, the following relay outputs can be controlled:

Checking outputs (relay test) (cont.)

| Display | Description |
|---------|--|
| 1 | Burner modulation - lower output |
| 2 | Burner modulation - upper output |
| 3 | Diverter valve set to heating mode |
| 4 | Valve in central position |
| 5 | Valve set to DHW mode |
| 6 | Internal pump / output 20 ON |
| 10 | Output $\overline{28}$ - internal extension |
| 11 | Heating circuit pump A1 - external extension |
| 12 | Cylinder loading pump - external extension |
| 13 | DHW circulation pump - external extension |
| 14 | Central fault - external extension |

Scanning operating conditions and sensors

Weather-compensated control unit

- For two heating circuits – select heating circuit:
 - Press \oplus .
 - 1 $\overline{\text{III}}$ flashes on the display.
 - Select heating circuit A1 (heating circuit without mixer):
Press OK .
 - Select heating circuit M2 (heating circuit with mixer):
 - Press \oplus .
 - 2 $\overline{\text{III}}$ flashes on the display.
 - Press OK .
2. Press i .
3. Select the required operating condition scan with \oplus or \ominus .
4. Press i .

Heating circuits A1 and M2

| Operating condition display (subject to system equipment level) | Description |
|---|---|
| User no. | Encoded user no. in the LON system |
| Holiday program | Only displayed if a holiday program has been set up |
| Date of departure | Date |
| Date of return | Date |
| Outside temperature, ... °C | Actual value |

Scanning operating conditions and sensors (cont.)

| Operating condition display (subject to system equip- ment level) | Description |
|--|---|
| Boiler temperature, ... °C | Actual value |
| Flow temperature, ... °C | Actual value (only for heating circuit M2) |
| Standard room temperature, ... °C | Set value |
| Room temperature, ... °C | Actual value |
| Ext. set room temp., ... °C | If external hook-up |
| DHW temperature, ... °C | Actual DHW temperature |
| Solar DHW temp., ... °C | Actual value |
| Collector temperature, ... °C | Actual value |
| Mixed flow temp., ... °C | Actual value, only with low loss header |
| Burner, ...h* ¹ | Hours run |
| Burner starts, ... * ¹ | Actual value |
| Solar energy | Display in kW/h |
| Time | |
| Date | |
| Burner OFF or ON | |
| Int. pump OFF or ON | Output 20 |
| Int. output OFF or ON | Internal extension |
| Heating pump OFF or ON | External extension or extension kit for one heat- ing circuit with mixer installed |
| Cylinder loading pump OFF or ON | Only displayed if the external extension is installed |
| DHW circulation pump OFF or ON | Only displayed if the external extension is installed |
| Central fault display OFF or ON | Only displayed if the external extension is installed |
| Mixer, mixer open or mixer close | Only displayed if the extension kit for 1 heating circuit with mixer is installed |
| Solar pump OFF or ON | Only displayed if Vitosolic is installed |
| Solar pump ...h | Hours run |
| Various languages | Each language can be selected as permanent display language with  . |

*¹Reset hours run and burner starts after maintenance has been completed. You can reset the hours run to 0 by pressing .

Scanning operating conditions and sensors (cont.)

Constant temperature control unit

1. Press **i**.
2. Select the required operating condition scan with **+** or **-**.
3. Press **i**.

| Operating condition display (subject to system equipment level) | | Description |
|---|------------|---|
| 1 | 15 °C/°F*1 | Outside temperature sensor - actual value (i): only if an outside temperature sensor is connected) |
| 3 | 65 °C/°F*1 | Boiler temperature sensor - actual value |
| 5 | 50 °C/°F*1 | Cylinder temperature sensor - actual value |
| 5□ | 45 °C/°F*1 | Solar - actual DHW temperature |
| 6 | 70 °C/°F*1 | Actual value - collector sensor |
| 263572 | h*2 | Burner hours run |
| 030529*2 | | Burner starts |
| 001417 | h | Hours run - solar circuit pump |
| 002850 | | Solar energy in kW/h |

*1 Display in °F if the relevant code has been selected and with the fourth display digit.

*2 Reset hours run and burner starts after maintenance has been completed. You can reset the hours run to 0 by pressing **+**.

Downloading fault codes history

The latest 10 faults are saved and may be called-up.

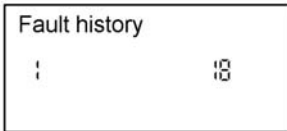

1. Press and simultaneously for approx. 2 seconds.

2. Call up the individual fault codes with or .



| Fault code order | Fault code |
|------------------|----------------------|
| 1 | most recent |
| . | . |
| . | . |
| . | . |
| 10 | 10. from most recent |

All saved fault codes can be deleted with .

3. Press .

Call up current fault codes

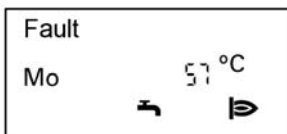

Red fault indicator flashes for all faults.

"Fault" flashes in the programming unit display when a fault message is issued.



A fault in the burner control unit causes the display to flash .

Call up current fault codes (cont.)

Control unit faults

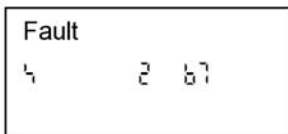
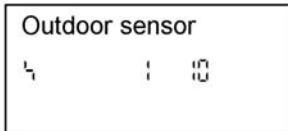

1. Find current fault with **(i)**.

2. Select additional fault codes with **(+)** and **(-)**.

3. Acknowledge fault

The fault can be acknowledged with **(OK)**. The fault message in the display will be hidden, but red fault indicator **(A)** continues to flash. A new fault message will be shown in the display if an acknowledged fault is not removed by 07:00 h the following day.

Fault on the burner control unit

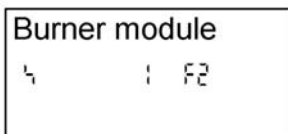

1. Find current fault with **(i)**.

2. Select additional fault codes with **(+)** and **(-)**.

3. Acknowledge fault

The fault can be acknowledged with **(OK)**. The fault message in the display will be hidden, but red fault indicator **(A)** continues to flash. A new fault message will be shown in the display if an acknowledged fault is not removed by 07:00 h the following day.

Call up current fault codes (cont.)

Fault display design

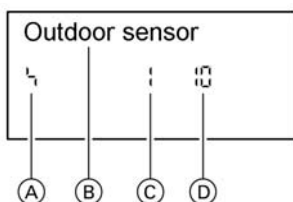

- (A) Fault symbol
- (B) Plain text fault display (only for weather-compensated control units)
- (C) Fault number
- (D) Fault code

1. Calling up acknowledged fault messages

Press **OK** for approx. 3 seconds.
The fault will then be displayed.

4. **↑** in the display indicates that the burner control unit is locked out.
After the fault has been removed, acknowledge by pressing reset **↑**.

Plain text fault display

- Burner control unit
- Outside temperature sensor
- Flow sensor
- Boiler sensor
- Mixed flow sensor
- DHW cylinder sensor
- Flue gas sensor
- DHW outlet sensor
- Room temperature sensor
- Collector sensor
- Solar DHW sensor
- Remote control

2. Select the acknowledged fault with **+** or **-**.

Checking and acknowledging faults

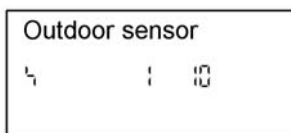

Weather-compensated control unit

Red fault indicator **↑** flashes for all faults.

A fault message code flashes in the programming unit display when a fault message is issued.

Any fault codes present may be called-up with **+** or **-**.

Checking and acknowledging faults (cont.)



Constant temperature control units

Note

The fault can be acknowledged with **OK**. The fault message in the display will be hidden, but the red fault indicator **|** continues to flash. A new fault message will be displayed if an acknowledged fault is not removed by the following morning.

Calling up acknowledged fault messages

Press **OK** for approx. 2 seconds; select the acknowledged fault with **+** or **-**.

| Fault code in the display | Const. | Weat-h. comp. | System characteristics | Cause | Remedy |
|---------------------------|--------|---------------|--|--|---|
| 0F | X | X | Control mode | Maintenance | Carry out maintenance. Set code 24:0 after maintenance. |
| 10 | X | X | Controls according to 0 °C outside temperature | Outside temperature sensor shorted out | Check the outside temperature sensor (see page 84). |
| 18 | X | X | | Outside temperature sensor lead break | |
| 20 | X | X | Controls without flow temperature sensor (low loss header) | System flow temperature sensor shorted out | Check the low loss header sensor (see page 86) |
| 28 | X | X | | System flow temperature sensor lead break | |

Checking and acknowledging faults (cont.)

| Fault code in the display | Const. | Weat-h. comp. | System characteristics | Cause | Remedy |
|----------------------------------|---------------|----------------------|-------------------------------|---|---|
| 30 | X | X | Burner blocked | Boiler temperature sensor shorted out | Check the boiler temperature sensor (see page 86) |
| 38 | X | X | | Boiler temperature sensor lead break | |
| 40 | | X | Mixer closes | Heating circuit M2 flow temperature sensor shorted out | Check the flow temperature sensor |
| 48 | | X | | Heating circuit M2 flow temperature sensor lead break | |
| 50 | X | X | No DHW heating | Cylinder temperature sensor/comfort sensor/loading sensor shorted out | Check sensors (see page 86) |
| 58 | X | X | | Cylinder temperature sensor/comfort sensor/loading sensor lead break | |
| 51 | X | X | No DHW heating | Cylinder temperature sensor 2/outlet sensor shorted out | Check sensors (see page 86) |
| 59 | X | X | | Cylinder temperature sensor 2/outlet sensor lead break | |
| 92 | X | X | Control mode | Solar: Collector temperature sensor shorted out | Check sensor |
| 9A | X | X | | Collector temperature sensor lead break | |
| 93 | X | X | Control mode | Solar: Sensor S3 shorted out | Check sensor |
| 9B | X | X | | Sensor S3 lead break | |
| 94 | X | X | Control mode | Solar: Cylinder temperature sensor shorted out | Check sensor |

Checking and acknowledging faults (cont.)

| Fault code in the display | Const. | Weat-h. comp. | System characteristics | Cause | Remedy |
|----------------------------------|---------------|----------------------|--------------------------------|--|--|
| 9C | X | X | | Cylinder temperature sensor lead break | |
| 9F | X | X | Control mode | Solar control unit fault message | See solar control unit service instructions |
| A7 | | X | Control mode | Faulty operating interface | Replace operating interface |
| b0 | X | X | Burner blocked | Flue gas temperature sensor short circuit | Check the flue gas temperature sensor (see page 88) |
| b8 | X | X | | Flue gas temp. sensor lead break | |
| b1 | X | X | Control mode | Communication fault – programming unit (internal) | Check connections and replace the programming unit, if necessary. |
| b4 | X | X | Emissions test mode | Internal fault analog converter | Replace control unit |
| b5 | X | X | Control mode | Internal fault | Replace control unit |
| b7 | X | X | Burner blocked | Boiler coding card missing, faulty or incorrect card inserted. | Plug in the boiler coding card or replace, if faulty. |
| bA | | X | Mixer M2 continues to regulate | Communication fault - extension kit for mixer circuit M2 | Check the extension kit connections and coding. Start the extension kit. |



Checking and acknowledging faults (cont.)

| Fault code in the display | Const. | Weat-h. comp. | System characteristics | Cause | Remedy |
|----------------------------------|---------------|----------------------|-------------------------------------|--|---|
| bC | | X | Control mode without remote control | Communication fault - Vitotrol remote control heating circuit A1 | Check connections, cable, coding address A0 and the remote control DIP switches |
| bd | | X | Control mode without remote control | Communication fault - Vitotrol remote control heating circuit M2 | |
| bE | | X | Control mode | Vitotrol remote control incorrectly encoded | Check the DIP switch settings of the remote control |
| bF | | X | Control mode | Incorrect LON communication module | Replace the LON communication module |
| C2 | X | X | Control mode | Communication fault - solar control unit | Check connections and coding address 54 |
| C5 | X | X | Control mode, max. pump speed | Communication fault - variable speed internal pump | Check coding address 30 settings; check the heating circuit pump DIP switch settings. |



Checking and acknowledging faults (cont.)

| Fault code in the display | Const. | Weat-h. comp. | System characteristics | Cause | Remedy |
|----------------------------------|---------------|----------------------|-------------------------------------|---|--|
| C6 | | X | Control mode, max. pump speed | Communication fault - variable speed heating circuit pump, heating circuit M2 | Check settings of coding address E5; check the heating circuit pump DIP switch settings. |
| C7 | X | X | Control mode, max. pump speed | Communication fault - variable speed heating circuit pump, heating circuit A1 | Check setting of coding address E5; check the heating circuit pump DIP switch settings. |
| Cd | X | X | Control mode | Communication fault Vitocom 100 (KM BUS) | Check connections and Vitocom 100 |
| CE | X | X | Control mode | Communication fault - ext. extension | Check connections and coding address 2E settings |
| CF | | X | Control mode | Communications fault - LON communication module | Replace the LON communication module |
| dA | | X | Control mode without room influence | Room temperature sensor heating circuit A1 shorted out | Check the room temperature sensor for heating circuit A1 |
| db | | X | | Heating circuit M2 room temperature sensor shorted out | Check the room temperature sensor for heating circuit M2 |



Checking and acknowledging faults (cont.)

| Fault code in the display | Const. | Weat-h. comp. | System characteristics | Cause | Remedy |
|----------------------------------|---------------|----------------------|-------------------------------|---|---|
| dd | | X | | Room temperature sensor heating circuit A1 lead break | Check the room temperature sensor for heating circuit A1 |
| dE | | X | | Heating circuit M2 room temperature sensor lead break | Check the room temperature sensor - heating circuit M2 |
| E4 | X | X | Burner blocked | Fault - supply voltage | Replace control unit |
| E5 | X | X | Burner blocked | Internal fault | Check the ionisation electrode and leads. Check flue gas system for soundness. Press  |
| E6 | X | X | Burner in fault state | Flue gas/air supply system blocked | Check the flue gas/air supply system. Check the air pressure switch and the interconnecting cables. Press  |
| F0 | X | X | Burner blocked | Internal fault | Replace control unit |



Checking and acknowledging faults (cont.)

| Fault code in the display | Const. | Weat-h. comp. | System characteristics | Cause | Remedy |
|----------------------------------|---------------|----------------------|-------------------------------|---|---|
| F1 | X | X | Burner in fault state | Flue gas temperature limiter has responded | Check the heating system water level. Vent the heating system. Press reset  no sooner than after 20 minutes. |
| F2 | X | X | Burner in fault state | Temperature limiter has responded | Check the heating system water level. Check the circulation pump. Vent the heating system. Check the temperature limiter and leads. Press  |
| F3 | X | X | Burner in fault state | The flame signal is already present at burner start | Check the ionisation electrode and leads. Press  |

Checking and acknowledging faults (cont.)

| Fault code in the display | Const. | Weat-h. comp. | System characteristics | Cause | Remedy |
|----------------------------------|---------------|----------------------|-------------------------------|-------------------------------------|--|
| F4 | X | X | Burner in fault state | No flame signal is present | Check the ionisation electrode and leads, measure the ionisation current, check the gas pressure, check the gas combination valve, ignition, ignition module, ignition electrodes and the condensate drain. Press  |
| F7 | X | X | Burner blocked | Differential pressure sensor faulty | Check the differential pressure sensor and lead. |
| F8 | X | X | Burner in fault state | Fuel valve closes too late | Check gas combination valve. Check both control paths. Press  |
| F9 | X | X | Burner in fault state | Fan speed too low at burner start | Check the fan, check the fan cables and supply, check the fan control. Press  |

Checking and acknowledging faults (cont.)

| Fault code in the display | Const. | Weat-h. comp. | System characteristics | Cause | Remedy |
|----------------------------------|---------------|----------------------|-------------------------------|--|--|
| FA | X | X | Burner in fault state | Fan stop not achieved | Check the fan, check the fan cables, check the fan control Press  |
| Fd | X | X | Burner blocked | Burner control unit fault | Check the ignition electrodes and leads. Check whether a strong interference (EMC) field exists near the equipment. Press  If the fault is not removed, replace the control unit. |
| FE | X | X | Burner blocked | Strong interference (EMC) field nearby; alternatively boiler coding card or main PCB faulty. | Remove EMC interference. If the equipment will not restart, check the boiler coding card and replace, or replace the control unit. |

Checking and acknowledging faults (cont.)

| Fault code in the display | Const. | Weat-h. comp. | System characteristics | Cause | Remedy |
|---------------------------|--------|---------------|------------------------|----------------|--|
| FF | X | X | Burner blocked | Internal fault | Remove EMC interference. If the equipment will not restart, check the boiler coding card and replace, or replace the control unit. |

Repairs

Checking the outside temperature sensor (weather-compensated control unit)

1. Pull plug X3 from the control unit.

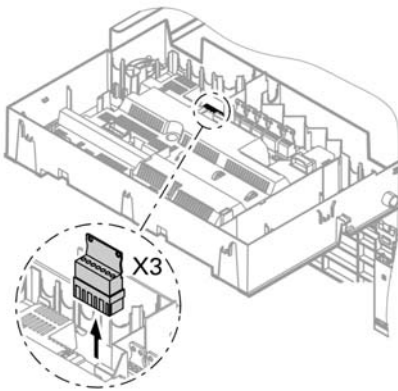

Repairs (cont.)

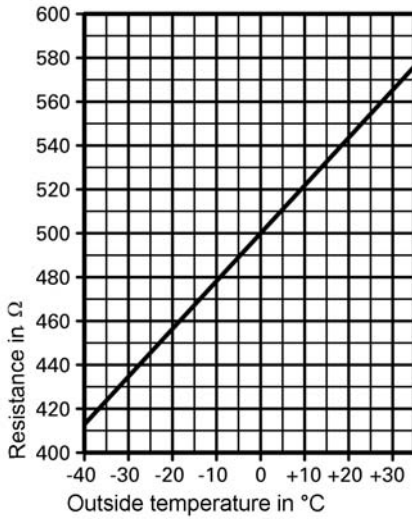

2. Test the resistance of the outside temperature sensor across terminals X3.1 and X3.2 on the disconnected plug and compare with the curve.
3. Where actual values strongly deviate from the curve values, disconnect the wires at the sensor, and repeat test directly at the sensor.
4. Depending on the result, replace cable or outside temperature sensor.

Repairs (cont.)

Checking the boiler temperature sensor, cylinder temperature sensor or the flow temperature sensor for the low loss header

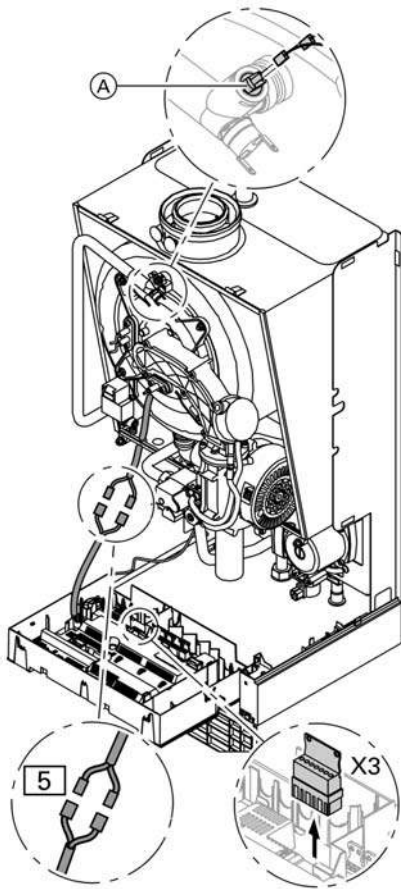

1. Boiler temperature sensor: Pull the leads from boiler temperature sensor (A) and measure the resistance.

Cylinder temperature sensor: Pull the plug 5 from the cable harness on the control unit and measure the resistance.

Flow temperature sensor: Pull plug X3 from the control unit and measure the resistance across terminals X3.4 and X3.5.

Repairs (cont.)

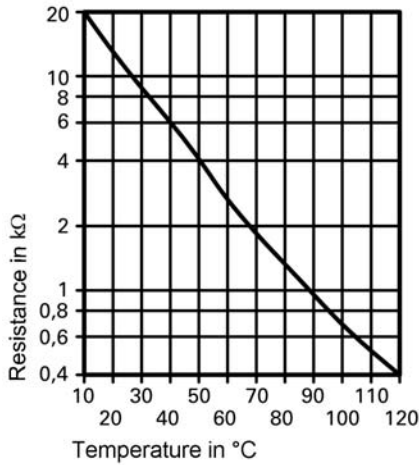

2. Check the sensor resistance and compare actual values with the curve.
3. Replace the sensor in case of severe deviation.



Danger

The boiler temperature sensor is immersed in the heating water (risk of scalding). Drain the boiler before replacing the sensor.

Checking the outlet or comfort sensor (only on gas fired combination boilers)

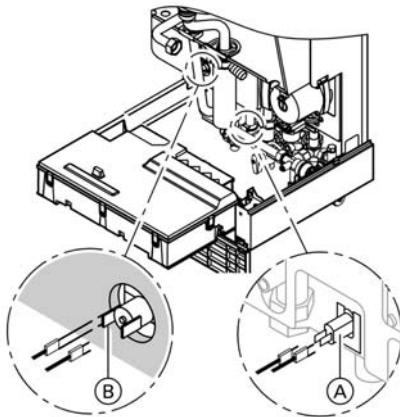

1. Pull the leads from outlet temperature sensor (A) or comfort sensor (B).
2. Check the sensor resistance and compare actual values with the curve.

Repairs (cont.)

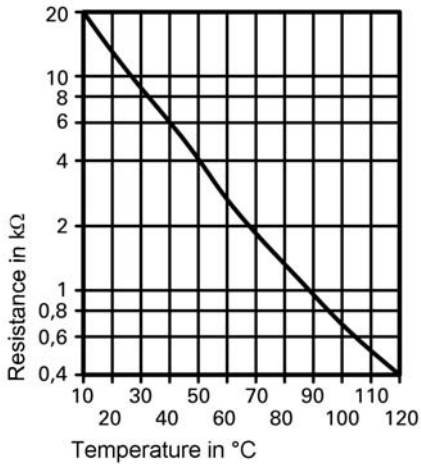

3. Replace the sensor in case of severe deviation.

Note

Water can leak out when replacing the outlet sensor. Close the cold water shut-off valve. Drain DHW pipe and plate heat exchanger (secondary side).

Checking the flue gas temperature sensor

The flue gas temperature sensor locks out the boiler when the permissible flue gas temperature is exceeded. The lockout can be reset no sooner than 20 minutes later by pressing the reset button .

Note

The equipment will also be locked out again for 20 minutes if the mains power supply is switched OFF.

Repairs (cont.)

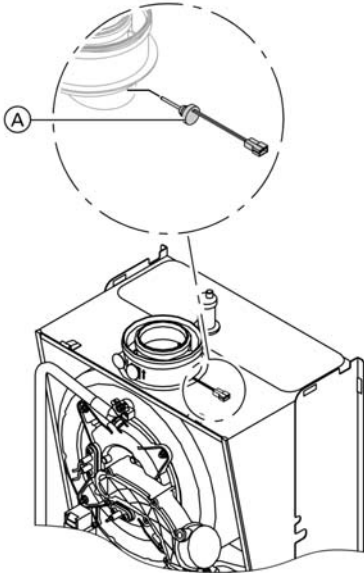

1. Pull the leads from the flue gas temperature sensor (A).
2. Check the sensor resistance and compare actual values with the curve.

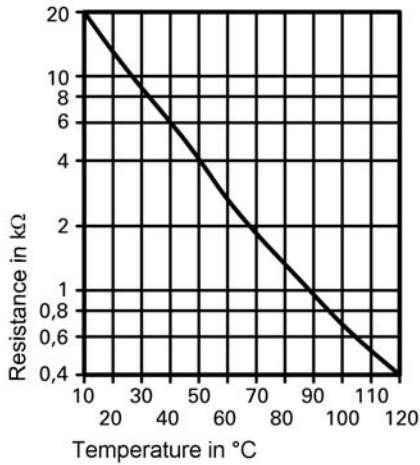

3. Replace the sensor in case of severe deviation.

Repairs (cont.)

Checking plate heat exchanger

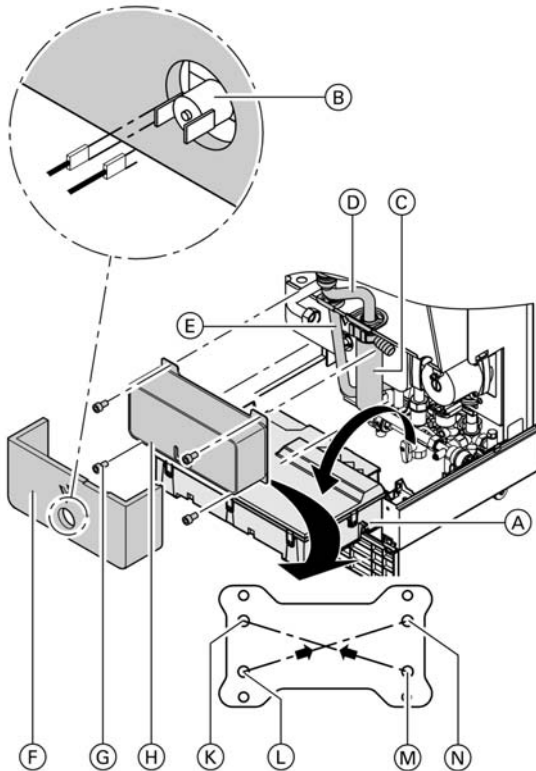

(K) Heating return



(L) Cold water

(M) Heating flow

(N) DHW

1. Shut off and drain the boiler on the primary and the secondary side.
2. Release the lateral closures and pivot the control unit (A) forward.
3. Pull leads from comfort sensor (B).
4. Remove the retaining clip and siphon (C).
5. Remove siphon pipe (D) from the heat exchanger, together with the inlet ferrule.
6. Fit gas supply pipe (E).
7. Remove thermal insulation (F).

Repairs (cont.)

8. Release screws  and pull plate heat exchanger  forward.

Note

During removal, small amounts of water may trickle out and escape from the removed plate heat exchanger.

9. Check the secondary side for scaling and, if necessary, clean or replace the plate heat exchanger.
10. Check the primary side for contamination and, if necessary, clean or replace the plate heat exchanger.

11. Install in reverse order using new gaskets. Lubricate the new gaskets/seals.

12.  **Danger**
Escaping gas leads to a risk of explosion.
Check the gas connections for soundness.

Check all fittings and the flange for soundness.

Repairs (cont.)

Check the temperature limiter

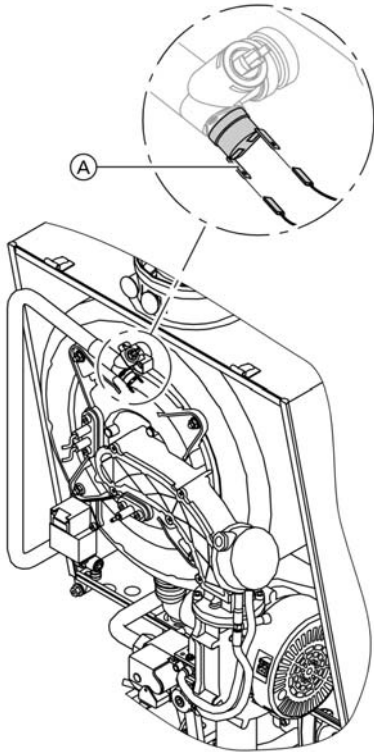

If the burner control unit cannot be reset after a fault shutdown, although the boiler water temperature is below approx. 75 °C:

- Pull the leads from thermocouple (A).
- Check the continuity of the thermocouple with a multimeter.
- Remove the faulty thermocouple.
- Install a new thermocouple.
- After commissioning, press reset button  on the control unit.

Repairs (cont.)

Checking the fuse

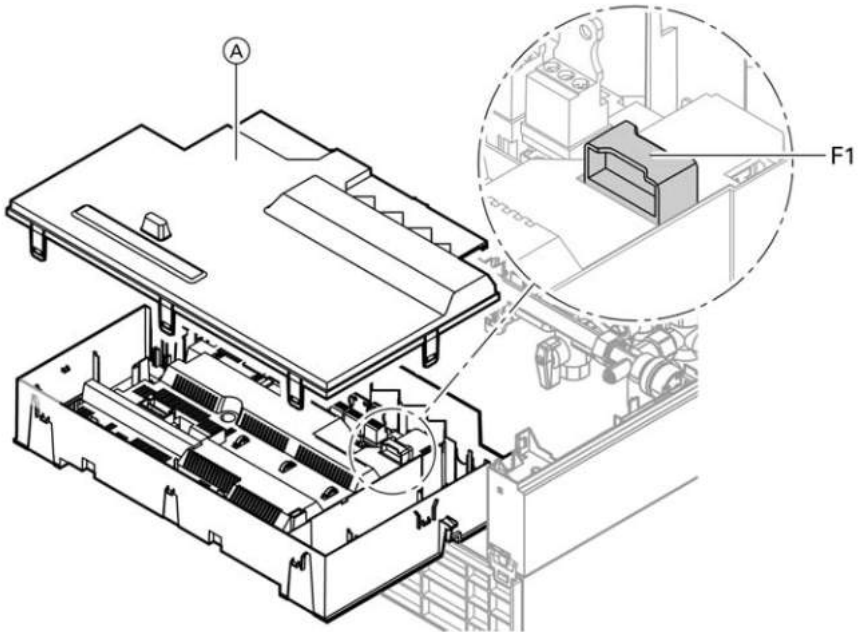

1. Switch OFF the mains power.
2. Release the lateral closures and pivot the control unit down.
3. Remove cover (A).
4. Check fuse F1.

Repairs (cont.)

Extension kit for heating circuit with mixer

Checking the rotational direction of the mixer motor

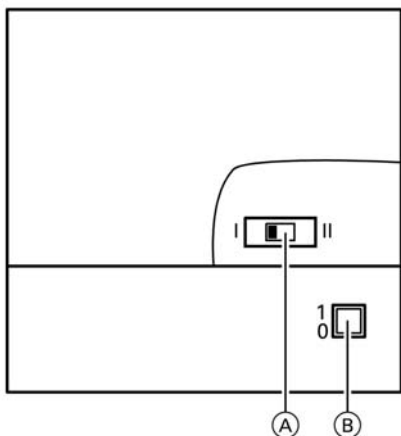

- Ⓐ Rotational direction switch
- Ⓑ ON/OFF switch ①

1. Switch OFF the motor and restart it at the main ON/OFF switch. The device will carry out the following self-test:
 - Mixer close (150 seconds)
 - Pump ON (10 seconds)
 - Mixer open (10 seconds)
 - Mixer close (10 seconds)Then standard control mode recommences.
2. Note the rotational direction of the mixer motor during the self-test. Then set the mixer manually to the "Open" position.

Note

The flow temperature sensor must now sense a higher temperature. If the temperature falls, either the motor is turning in the wrong direction or the mixer set is incorrectly fitted.



Mixer installation instructions.

3. Adjust the rotational direction of the mixer motor (if required).
 - Switch position I for heating return from the l.h. side (as delivered condition).
 - Switch position II for heating return from the r.h. side.

Repairs (cont.)

Checking Vitotronic 050 (accessory)

Vitotronic 050 is connected to the control unit via the LON system. To test the connection, implement a user check on the boiler control unit (see page 33).

Constant temperature control unit

Heating mode

The set boiler water temperature will be maintained in the heating and DHW operating program , when a demand is raised by the room temperature dependent clock thermostat. If no demand is received, the boiler water temperature will be held at the defaulted frost protection temperature. The burner control unit limits the boiler water temperature: Through the control thermostat to 74 °C, and through the electronic temperature limiter to 82 °C. The temperature limiter in the safety chain locks out the burner control unit at a boiler water temperature of 100 °C.

DHW loading with gas fired combination boilers

If the flow switch recognises that DHW is drawn off (> 3 l), the burner and circulation pump are switched ON, and the three-way valve changes over to DHW loading (display symbol ). The burner modulates to reach the DHW outlet temperature and is limited on the boiler side by the temperature limiter (82 °C). With activated comfort operation, the plate heat exchanger will be held to a standby temperature of "42 °C ON" and "46 °C OFF".

DHW loading with a gas fired boiler

The DHW heating will be activated if the cylinder temperature falls 2.5 K below the set cylinder temperature. The burner, the circulation pump and the three-way valve are started or changed over. In the delivered condition, the set boiler temperature lies 20 K higher than the set cylinder temperature (adjustable in coding address 60). If the actual cylinder temperature rises 2.5 K above the set cylinder temperature, the burner will be switched OFF and the cylinder loading pump run-on time will be activated.

Constant temperature control unit (cont.)

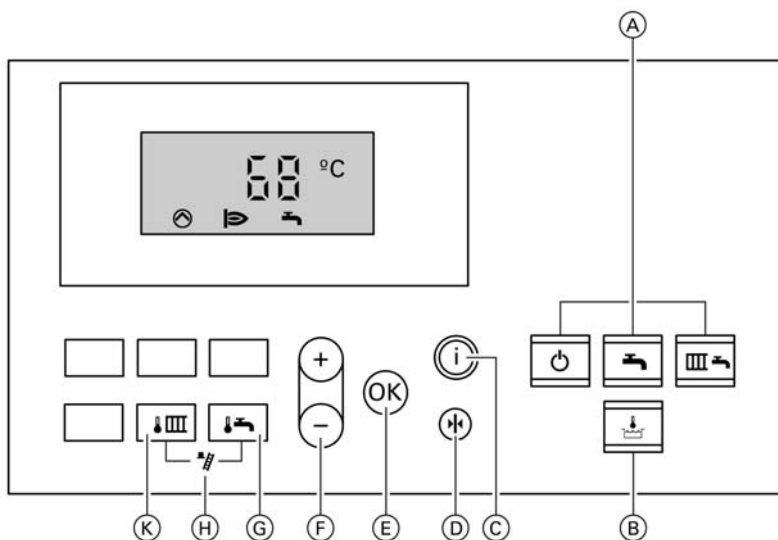

- | | |
|--------------------------------|----------------------------|
| Ⓐ Heating programs | Ⓕ Setting values |
| Ⓑ Comfort mode | Ⓖ DHW temperature |
| Ⓒ Information | Ⓗ Emissions test function |
| Ⓓ Basic settings | Ⓚ Boiler water temperature |
| Ⓔ Confirmation/acknowledgement | |

Weather-compensated control unit

Heating mode

The control unit determines a set boiler water temperature subject to outside temperature or room temperature (if a room temperature dependent remote control is connected) and the slope/level of the heating curve. The determined set boiler water temperature is then transferred to the burner control unit. From the set and actual boiler water temperatures, the burner control unit calculates the modulation level and controls the burner accordingly. The burner control unit limits the boiler water temperature: Through the control thermostat to 74 °C, and through the electronic temperature limiter to 82 °C. The temperature limiter in the safety chain locks out the burner control unit at a boiler water temperature of 100 °C.

DHW loading with gas fired combination boilers

If the flow switch recognises that DHW is drawn off (> 3 l), the burner and circulation pump are switched ON, and the three-way valve changes over to DHW loading. The burner modulates to reach the DHW outlet temperature and is limited on the boiler side by the temperature limiter (82 °C). With activated comfort operation, the plate heat exchanger will be held to a standby temperature of "42 °C ON" and "46 °C OFF".

DHW loading with a gas fired boiler

The DHW heating will be activated if the cylinder temperature falls 2.5 K below the set cylinder temperature. The burner and the cylinder loading pump are switched ON. In the delivered condition, the set boiler water temperature lies 20 K higher than the set cylinder temperature. If the actual cylinder temperature rises 2.5 K above the set cylinder temperature, the burner will be switched OFF and the cylinder loading pump run-on time will be activated.

Supplementary DHW heating

The backup heating function is activated if a switching period is selected for the fourth time phase. This period must lie outside the switching times for standard DHW heating to enable the control unit to recognise the signal. The set temperature value for backup heating is adjustable in coding address 58.

Extensions for external connections (accessory) (cont.)

Internal extension H2

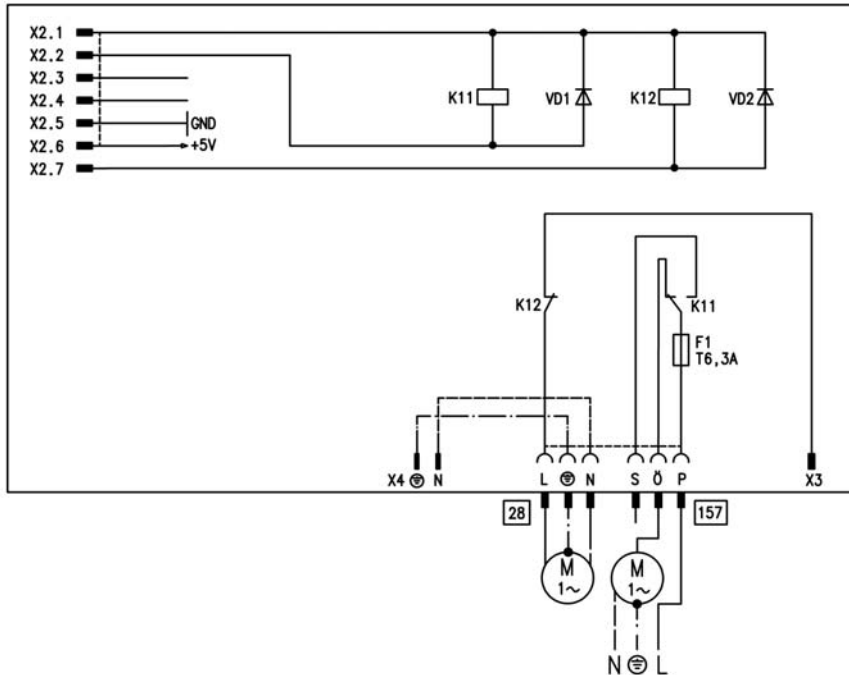

The internal extension is integrated into the control unit housing. As alternative, the following functions can be connected to relay output [28]. The function is allocated via coding address 53:

- Central fault message (code 53:0)
- Cylinder loading pump (code 53:3)
- DHW circulation pump (code 53:1)
- Heating circuit pump for heating circuit without mixer (code 53:2)

An interlock for extractors can be joined to connection [157].

Extensions for external connections (accessory) (cont.)

External extension H1

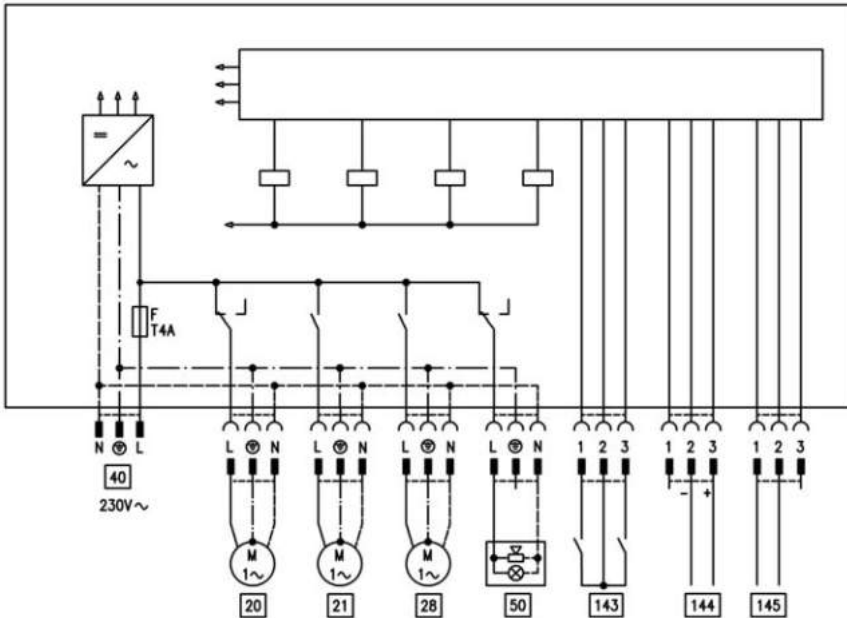

The external extension is connected to the boiler control unit via the KM BUS. The following functions can be controlled or processed simultaneously via the extension:

- 20** Heating circuit pump for heating circuit without mixer
- 21** Cylinder loading pump
- 28** DHW circulation pump
- 40** Power supply
- 50** Central fault message

- 143** ■ External blocking (terminals 2 - 3)
 - External demand (terminals 1 - 2)
 - External changeover of the operating mode (terminals 1 - 2)
- The allocation of function "External changeover of operating mode" is selected via coding address 91.

144 External set value 0 to 10 V

145 KM BUS

Extensions for external connections (accessory) (cont.)

External extension H2

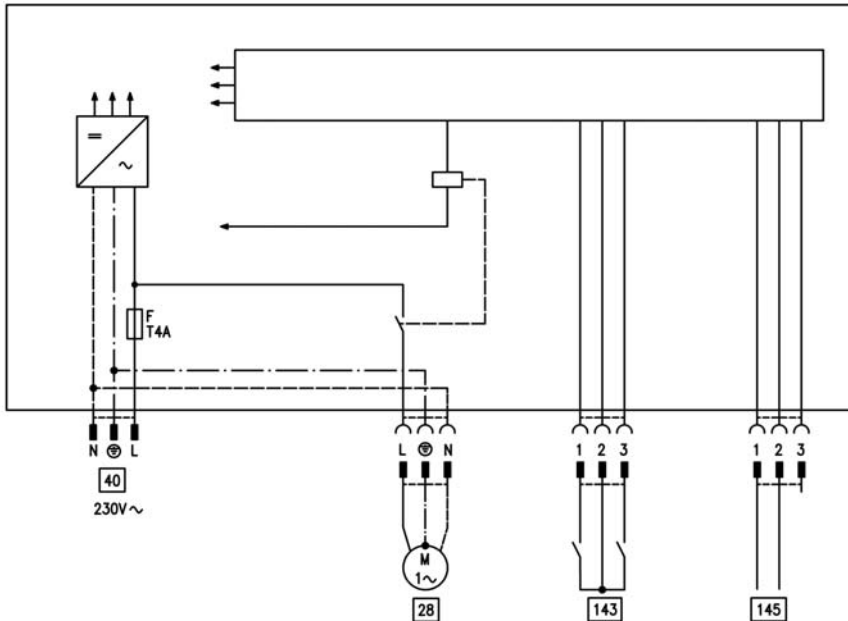

The external extension is connected to the boiler control unit via the KM BUS. The following functions can be controlled or processed simultaneously via the extension:

- 28 DHW circulation pump
- 40 Power supply

- 143 ■ External blocking (terminals 2 - 3)
- External demand (terminals 1 - 2)
- External changeover of operating mode (terminals 1 - 2)
The allocation of the "External changeover of operating mode" function is selected via coding address 91.
- 145 KM BUS

Function description

Control functions

External changeover of operating mode

The "Ext. changeover of operating mode" function is connected via external extension input [143]. With coding address 91 you can select the heating circuit to which the changeover of operating mode should apply:

| Coding | Changeover of operating mode affects: |
|--------|--|
| 91:0 | No changeover |
| 91:1 | Heating circuit without mixer A1 |
| 91:2 | Heating circuit with mixer M2 |
| 91:3 | Heating circuit without mixer and heating circuit with mixer |

With coding address d5, you can select in which direction the changeover should be made for each heating circuit:

| Coding | Changeover of operating mode affects: |
|--------|--|
| d5:0 | Changeover towards "Constantly reduced" or "Constant standby mode" (subject to the selected set value) |
| d5:1 | Changeover towards "Constant heating mode" |

You can select the duration of the operating mode changeover with coding address F2.

| Coding | Changeover of operating mode affects: |
|---------------|---|
| F2:0 | No changeover of operating mode |
| F2:1 to F2:12 | Duration of the operating mode changeover 1 to 12 hours |

The changeover of operating mode remains active for as long as the contact remains closed, but no less than the default duration selected with coding address F2.

Control functions (cont.)

External blocking

The "External blocking" function is connected via input **143** of the external extension.

In coding address 32 you can select the influence the "Ext. blocking" signal should have on the connected circulation pumps.

External demand

The "External demand" function is connected via input **143** of the external extension.

In coding address 34 you can select the influence the "Ext. demand" signal should have on the connected circulation pumps.

In coding address 9b, you can select the minimum set boiler water temperature in case of external demand.

Venting program

Note

Close the gas shut-off valve when operating the venting program.

During the venting program, the circulation pump will be alternately switched ON and OFF for 30 seconds respectively over a period of 20 minutes.

The diverter valve is alternately switched for a certain period towards heating and DHW operation. The burner is switched OFF during the venting program.

The venting program is activated via coding address 2F:1. The program is automatically deactivated after 20 minutes, and the coding address is set to 0.

Filling program

Note

Close the gas shut-off valve when operating the filling program.

In the delivered condition, the diverter valve is set to its central position, enabling the system to be filled completely. After starting the control unit, the diverter valve no longer goes into its central position.

Function description

Control functions (cont.)

The diverter valve can be moved into its central position via coding address 2F:2. The system can be filled completely, if the control unit is switched OFF in this position.

Filling with the control unit switched ON

If the system is to be filled with the control unit switched ON, the diverter valve is moved into its central position via coding address 2F:2, and the pump is started. The burner shuts down if this program is activated via coding address 2F. The program is automatically deactivated after 20 minutes, and the coding address is set to 0.

Screed function

The screed drying function enables the drying of a freshly laid screed. For this, always observe the instructions issued by the screed manufacturer.

Various temperature profiles are available for selection.

Temperature profile: Diagram 1 (DIN 4725 part 4) code F1:1

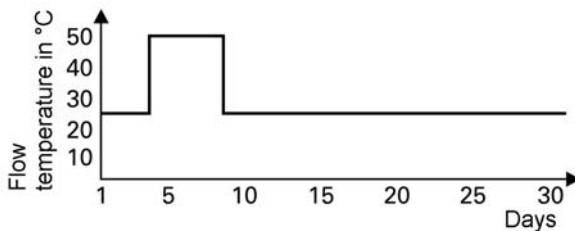

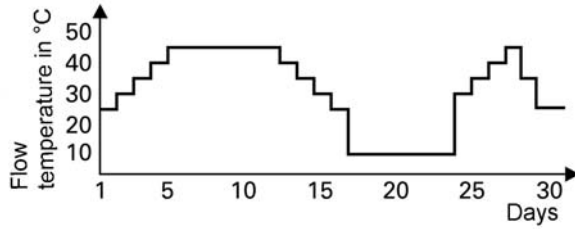
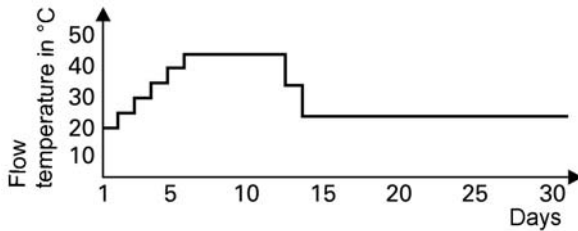
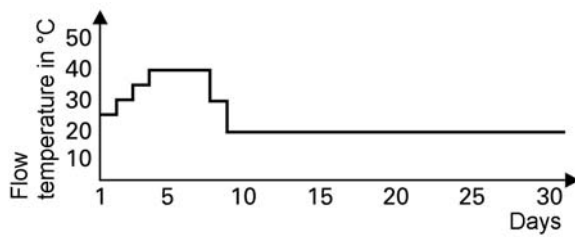
Control functions (cont.)**Temperature profile: Diagram 2 code F1:2****Temperature profile: Diagram 3 code F1:3****Temperature profile: Diagram 4 code F1:4**

Function description

Control functions (cont.)

Temperature profile: Diagram 5 code F1:5

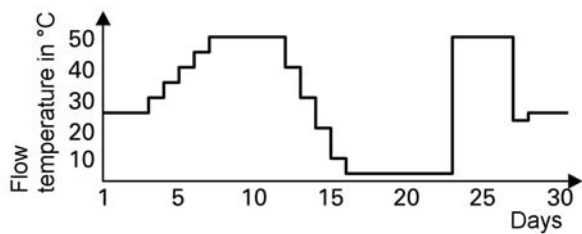

Temperature profile: Factory-set code F1:6 to F1:15

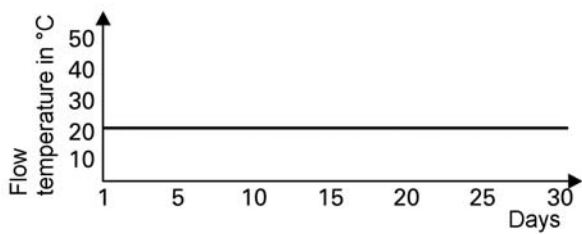

Designs

Connection and wiring diagrams – internal connectio . . . (cont.)

- | | | | |
|----|---|-----|-------------------------------|
| 5 | Cylinder temperature sensor (gas fired boiler) | 30 | Step motor for diverter valve |
| | Comfort sensor (gas combina- tion boiler) | 47 | Temperature limiter |
| | (Plug on the cable harness) | 54 | Ignition unit |
| 11 | Ionisation electrode | 100 | Fan motor |
| 15 | Flue gas temperature sensor | 131 | Air pressure switch |
| | | 149 | Flow switch |

Connection and wiring diagrams – external connections

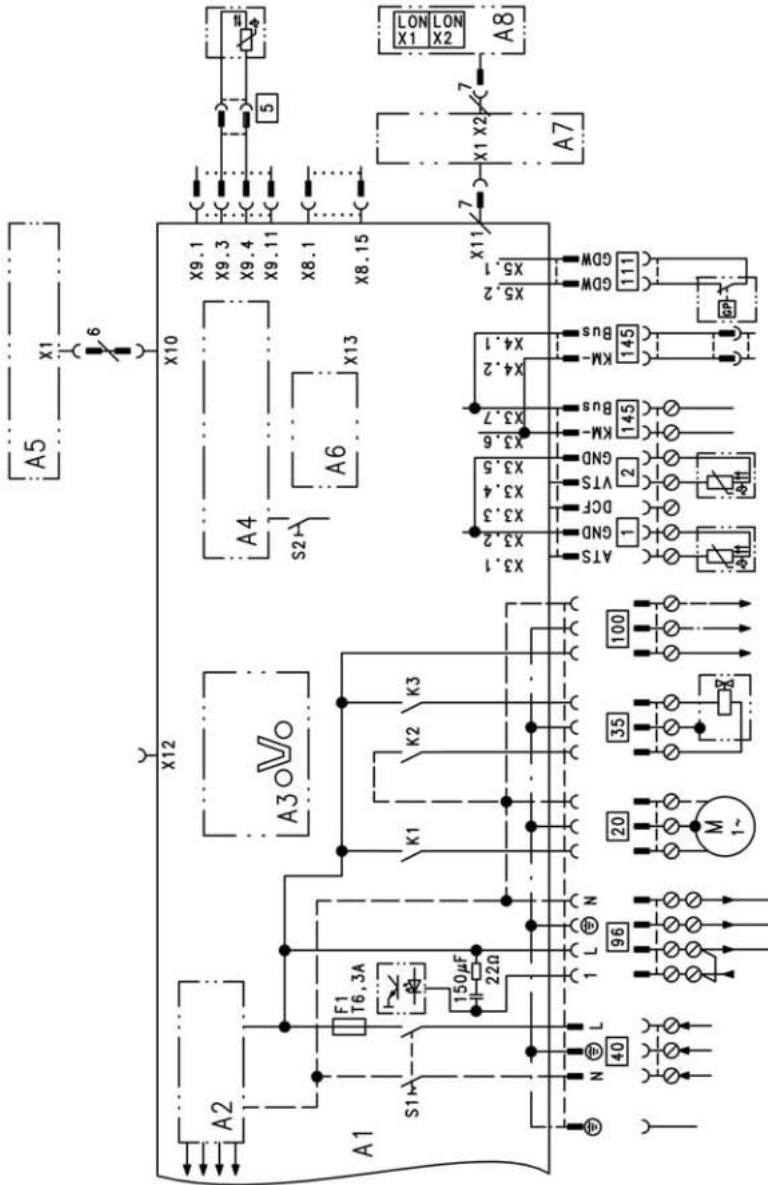

5692.573 GB

A1 Main PCB

A2 Mains supply unit

Connection and wiring diagrams – external connectio . . . (cont.)

| | | | |
|----|---|-----|---|
| A3 | Optolink | 5 | Cylinder temperature sensor |
| A4 | Burner control unit | 20 | Internal circulation pump |
| A5 | Operating interface | 35 | Gas solenoid valve |
| A6 | Coding card | 40 | Power supply |
| A7 | Connection adaptor | 96 | Mains power supply - accessories and Vitotrol 100 |
| A8 | LON communication module | 100 | Fan motor |
| S1 | ON/OFF switch | 111 | Gas governor |
| S2 | Reset button | 145 | KM BUS |
| 1 | Outside temperature sensor | | |
| 2 | Flow temperature sensor low loss header | | |

Parts lists

Spare parts information

Quote the type and serial no. (see type plate) and the item no. of the required part (as per this parts list).

Obtain standard parts from your local supplier.

| | |
|---|--|
| 001 Quick-acting air vent valve | 034 Return pipe with gasket (item 041) |
| 002 Connection pipe with gasket (item 041) | 035 Ventilation air gasket |
| 003 Thermocouple | 036 Flue gas gasket |
| 004 Temperature sensor | 037 Diaphragm expansion vessel |
| 005 Boiler adaptor grommets | 038 Connection line - diaphragm expansion vessel |
| 006 Temperature sensor heat exchanger* ¹ | 039 Rear panel lid |
| 007 Profiled gasket | 040 Clip nut |
| 008 Thermal insulation - heat exchanger* ¹ | 050 Burner gasket |
| 009 Safety spring | 051 Insulation ring |
| 010 Pump motor | 052 Burner gauze assembly |
| 011 DHW valve* ¹ | 053 Burner gauze assembly gasket |
| 012 Flue gas temperature sensor | 056 Air pressure switch |
| 013 Siphon | 057 Control cables |
| 014 Heat exchanger | 058 Mixture damper |
| 015 Heat exchanger siphon connection | 059 Fan |
| 017 O-ring 28 x 2.5 mm | 060 Venturi top |
| 018 Condensate hose | 061 Gas combination valve |
| 019 Boiler connection plug (2 pieces) | 062 Burner door |
| 020 Heat exchanger gasket set* ¹ | 063 Ignition unit |
| 021 Plate heat exchanger* ¹ | 064 Conversion kit for natural gas E (gas restrictor) |
| 022 Pressure gauge | 065 Conversion kit for natural gas LL (gas restrictor) |
| 023 Flow switch* ¹ | 066 Conversion kit for LPG P (gas restrictor) |
| 024 Water level limiter* ¹ | 080 Vitodens control unit |
| 025 Linear step motor | 081 Rear cover |
| 026 Boiler adaptor (with items 019, 035, 036) | 082 Support |
| 028 Plug-in connector retainer (2 pieces) | 083 Damper |
| 029 Front plate (with item 030) | 084 Pressure gauge retainer |
| 030 Retaining clip (set) | 085 Clip |
| 031 Hook-in lock (set) | 086 Hinge |
| 032 Cover profile (with item 007) | 087 Internal extension (accessory) |
| 033 Gas supply pipe | 088 LON communication module (accessory) |

*¹Only for serial no. 7176541....

Parts lists

Parts lists (cont.)

- | | |
|--|---|
| 089 Connection adaptor | 042 Fastenings |
| 090 Coding card | 097 Step motor connecting cable |
| 091 Fuses (10 pieces) | 098 Internal ionisation lead |
| 092 Operating interface for constant temperature operation | 099 Ionisation lead with strain relief |
| 093 Operating interface for weather-compensated operation | 100 Cable harness X8/X9*1 |
| 095 Locking clips (10 pieces) | 101 Cable harness 100/35/34 (auxiliary earth) |
| 096 Outside temperature sensor | 102 Cable harness X8/X9*1 |
| Wear parts | 150 Installation instructions |
| 054 Ignition electrode with gasket | 151 Service instructions |
| 055 Ionisation electrode with gasket | 152 Operating instructions for constant temperature operation |
| Parts not shown | 153 Operating instructions for weather-compensated operation |
| 016 Special grease | 155 Touch-up spray paint, Vitowhite |
| 041 Plug-in connection gasket set | 156 Touch-up paint stick, Vitowhite |
| | Ⓐ Type plate |

*1 Only for serial no. 7176543....

Parts lists (cont.)

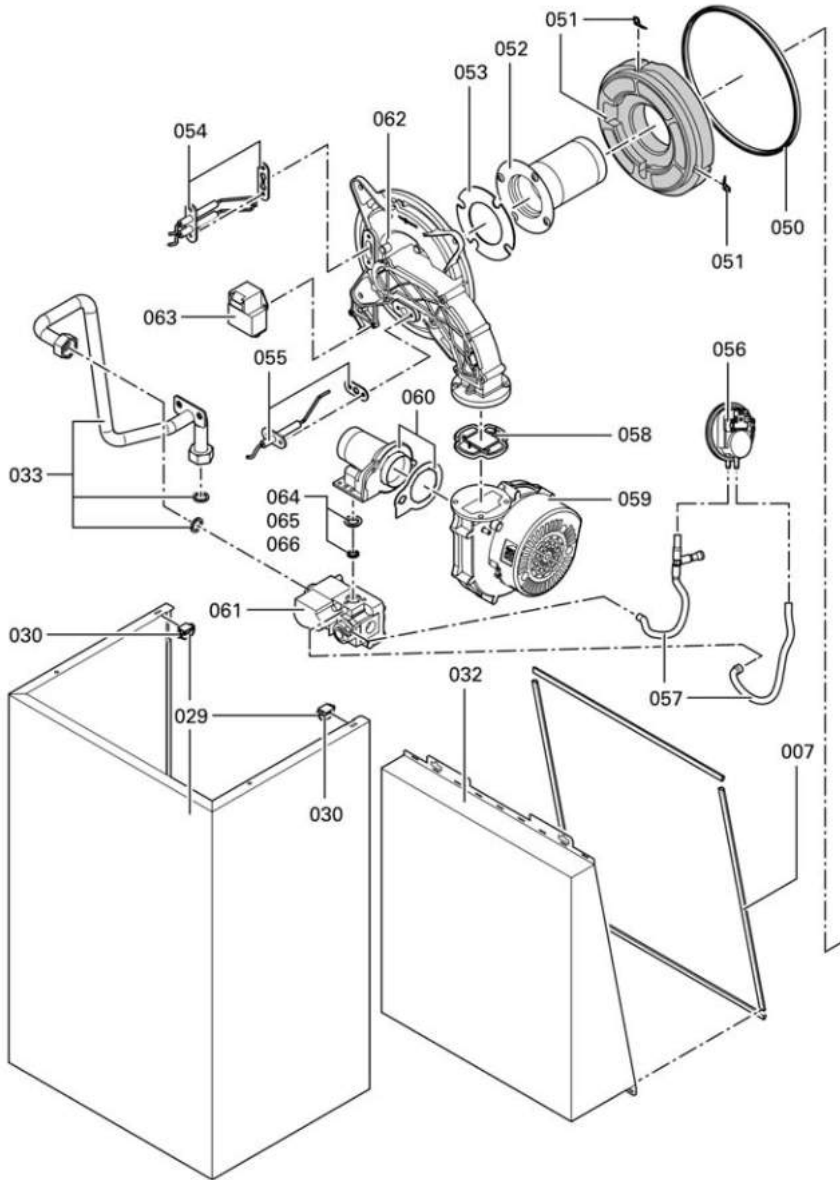

Parts lists

Parts lists (cont.)

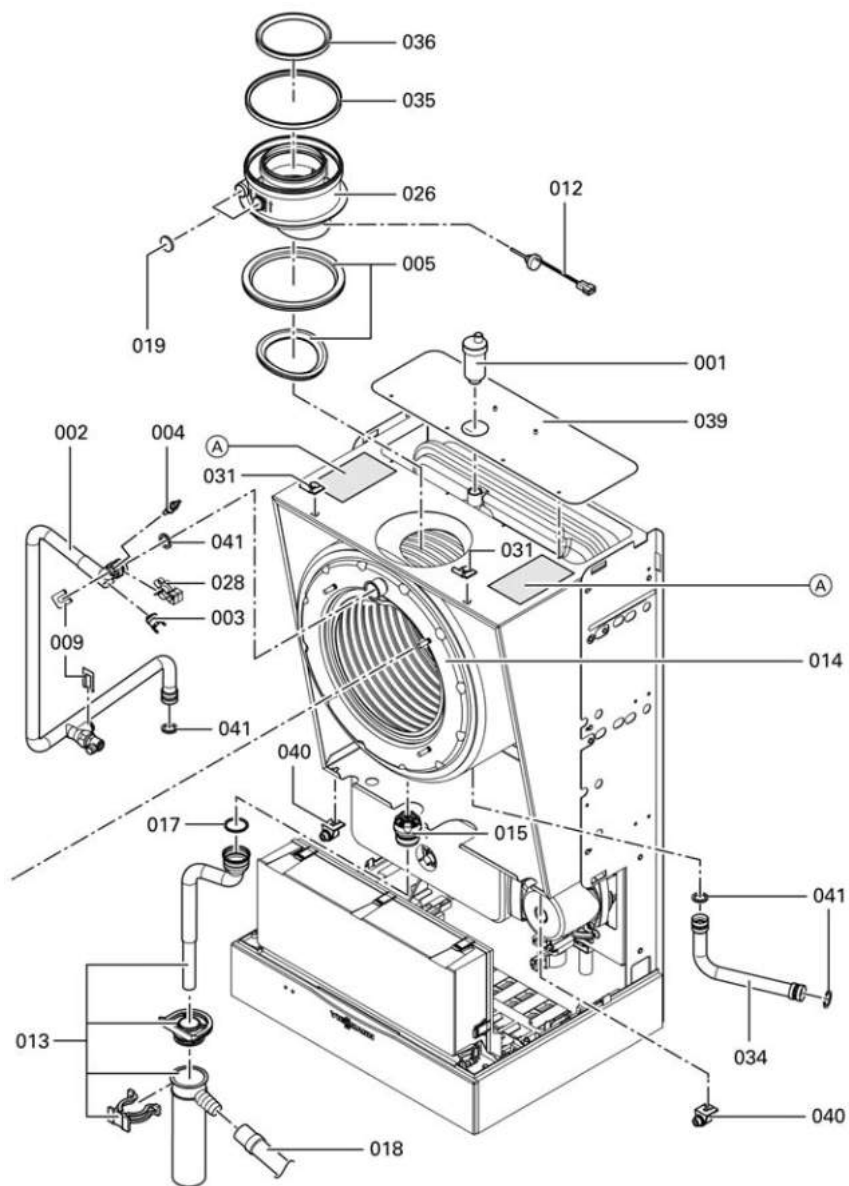

5692 573 GB

Parts lists (cont.)

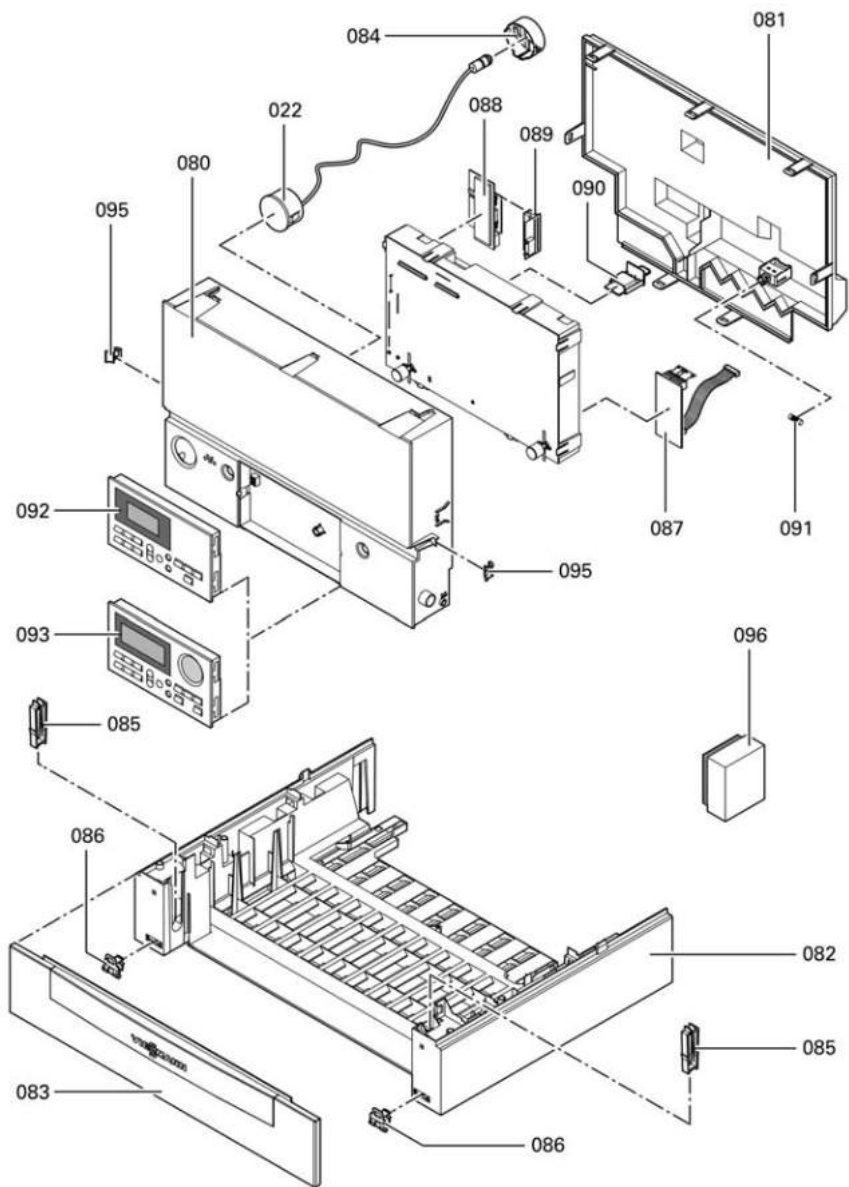

Parts lists (cont.)

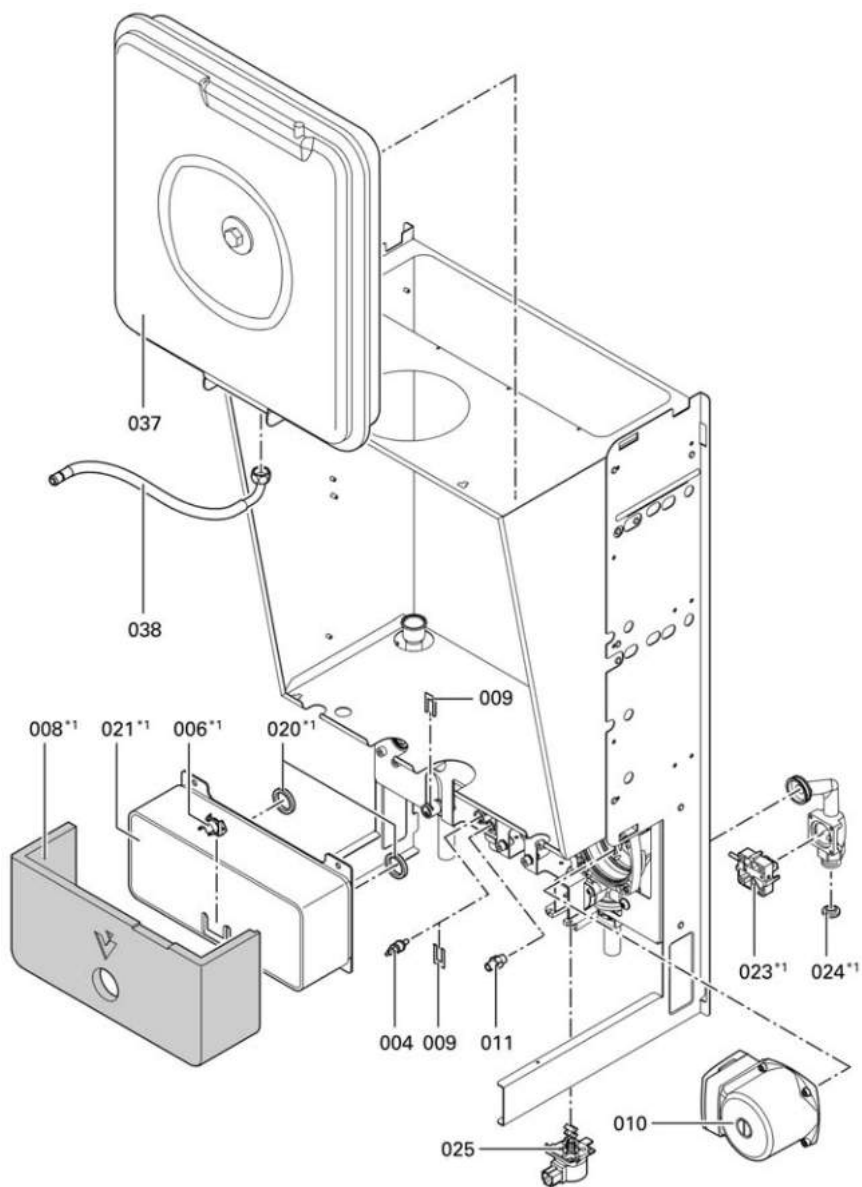

Parts lists (cont.)

Commissioning/service reports

| Setting and test values | Set value | Initial start-up |
|--|------------------|-------------------------|
| Date: | | |
| By: | | |
| Static pressure | <i>mbar</i> | Max. 57.5 mbar |
| Supply pressure (flow pressure) | | |
| <input type="checkbox"/> for natural gas E | <i>mbar</i> | 17.4 to 57.5 mbar |
| <input type="checkbox"/> for natural gas LL | <i>mbar</i> | 17.4 to 57.5 mbar |
| <input type="checkbox"/> for LPG | <i>mbar</i> | 42.5 to 57.5 mbar |
| <i>Tick gas type</i> | | |
| Carbon dioxide content CO₂ | | |
| ■ at lower rated output | <i>% by vol.</i> | |
| ■ at upper rated output | <i>% by vol.</i> | |
| Oxygen content O₂ | | |
| ■ at lower rated output | <i>% by vol.</i> | |
| ■ at upper rated output | <i>% by vol.</i> | |
| Carbon monoxide content CO | | |
| ■ at lower rated output | <i>ppm</i> | |
| ■ at upper rated output | <i>ppm</i> | |
| Ionisation current | <i>µA</i> | Min. 4 µA |

Commissioning/service reports (cont.)

| Setting and test values | Set value | Maintenance/ service |
|--|----------------------|---------------------------------|
| Date: | | |
| By: | | |
| Static pressure | <i>mbar</i> | Max. 57.5 mbar |
| Supply pressure (flow pressure) | | |
| <input type="checkbox"/> for natural gas E | <i>mbar</i> | 17.4 to 57.5 mbar |
| <input type="checkbox"/> for natural gas LL | <i>mbar</i> | 17.4 to 57.5 mbar |
| <input type="checkbox"/> for LPG | <i>mbar</i> | 42.5 to 57.5 mbar |
| <i>Tick gas type</i> | | |
| Carbon dioxide content CO₂ | | |
| ■ at lower rated output | <i>% by vol.</i> | |
| ■ at upper rated output | <i>% by vol.</i> | |
| Oxygen content O₂ | | |
| ■ at lower rated output | <i>% by vol.</i> | |
| ■ at upper rated output | <i>% by vol.</i> | |
| Carbon monoxide content CO | | |
| ■ at lower rated output | <i>ppm</i> | |
| ■ at upper rated output | <i>ppm</i> | |
| Ionisation current | <i>µA</i> | Min. 4 µA |

Commissioning/service reports

Commissioning/service reports (cont.)

| Setting and test values | Set value | Maintenance/ service |
|--|----------------------|---------------------------------|
| Date: | | |
| By: | | |
| Static pressure | <i>mbar</i> | Max. 57.5 mbar |
| Supply pressure (flow pressure) | | |
| <input type="checkbox"/> for natural gas E | <i>mbar</i> | 17.4 to 57.5 mbar |
| <input type="checkbox"/> for natural gas LL | <i>mbar</i> | 17.4 to 57.5 mbar |
| <input type="checkbox"/> for LPG | <i>mbar</i> | 42.5 to 57.5 mbar |
| <i>Tick gas type</i> | | |
| Carbon dioxide content CO₂ | | |
| ■ at lower rated output | <i>% by vol.</i> | |
| ■ at upper rated output | <i>% by vol.</i> | |
| Oxygen content O₂ | | |
| ■ at lower rated output | <i>% by vol.</i> | |
| ■ at upper rated output | <i>% by vol.</i> | |
| Carbon monoxide content CO | | |
| ■ at lower rated output | <i>ppm</i> | |
| ■ at upper rated output | <i>ppm</i> | |
| Ionisation current | <i>µA</i> | Min. 4 µA |

Specification

Specification

| | | | |
|---------------------------------|---------------|---|----------------|
| Rated voltage: | 230 V~ | Electronic temperature limiter setting: | 82 °C (fixed) |
| Rated frequency: | 50 Hz | Temperature limiter setting: | 100 °C (fixed) |
| Rated current: | 6 A~ | Mains fuse: | Max. 16 A |
| Safety class: | I | | |
| | IP X 4 D to | | |
| Protection level: | EN 60 529 | | |
| Permissible ambient temperature | | Power consumption | |
| ■ in operation: | 0 to +40 °C | ■ Circulation pump: | Max. 115 W |
| ■ during storage and transport: | -20 to +65 °C | ■ Burner: | Max. 60 W |
| | | ■ Control unit: | Max. 10 VA |

Gas fired boiler, category II 2ELL3P

| | | |
|---------------------------------|---|---------------------------|
| Rated output range | kW | 8.8 to 26/28*1 |
| Rated thermal load range | kW | 8.4 to 25.7/29.5*1 |
| Connection values*2 | | |
| Relative to the max. load with | | |
| | with H _{uB} | |
| Natural gas E | 9.45 kWh/m ³ 34.02 MJ/m ³ | m ³ /h 3.12 |
| Natural gas LL | 8.13 kWh/m ³ 29.25 MJ/m ³ | m ³ /h 3.63 |
| LPG | 12.79 kWh/m ³ 46.04 MJ/m ³ | m ³ /h 2.31 |
| Product ID | CE-0085 BO 0342 | |

Product characteristics (to EnEV [Germany])

| | | |
|---|-----------|---------------------|
| Rated output range | kW | 8.8 to 26/28 |
| Efficiency η at | | |
| ■ 100 % of the rated output | % | 96.0 |
| ■ 30 % of the rated output | % | 106.8 |
| Standby loss $q_{B,70}$*3 | % | 0.8 |
| Power consumption*3 for | | |
| ■ 100 % of the rated output | W | 207 |
| ■ 30 % of the rated output | W | 132 |

*1 Rated output or rated thermal load during DHW heating.

*2 The supply values are only for reference (e.g. in the gas contract application) or to estimate the supplementary volumetric settings. Because of factory settings, the gas pressure must not be altered from these values. Reference: 15 °C, 1013 mbar.

*3 Max. limit to EnEV.

Declaration of conformity

Declaration of Conformity for Vitodens 200

We, Viessmann Werke GmbH & Co KG, D-35107 Allendorf, declare as sole responsible body, that the product

Vitodens 200

conforms to the following standards:

DIN 4702-6
 EN 297
 EN 483
 EN 625
 EN 677
 EN 50 165
 EN 60 335
 EN 61 000-3-2
 EN 61 000-3-3

This product is designated in accordance with the following directives:

90/396/EEC
 89/336/EEC
 73/23/EEC
 92/42/EEC

as follows:
CE-0085

EC Declaration of Conformity by an authorised body according to EMVG article 10.2 Certificate number: E9 02 08 1730.

This product complies with the requirements of the Efficiency Directive (92/42/EEC) for:

Condensing boilers

The product characteristics determined as system values for the product **Vitodens 200 as part of EC type testing according to the Efficiency Directive** (see specification table), can be utilised to assess the energy consumption of heating and ventilation equipment to DIN V 4701-10 which is specified by the EnEV [Germany].

Allendorf, 02.06.04

Viessmann Werk GmbH&Co KG



pp. Manfred Sommer

Certificates

Manufacturer's certificate according to the 1st BImSchV [Germany]

We, Viessmann Werke GmbH & Co KG, D-35107 Allendorf, confirm that the following product meets the NO_x limits specified by 1st BImSchV Paragraph 7 (2):

Vitodens 200

Allendorf, 02.06.04

Viessmann Werk GmbH&Co KG

A handwritten signature in black ink, appearing to read 'M. Sommer', is written over the printed name.

pp. Manfred Sommer

Keyword index

| | |
|---|----------|
| A | |
| Adjusting the room temperature | 35 |
| B | |
| Boiler temperature sensor | 86 |
| Brief scan | 64 |
| Burner gauze assembly | 21 |
| Burner installation | 23 |
| Burner removal | 20 |
| C | |
| Checking outputs | 68 |
| Cleaning agent | 23 |
| Cleaning the combustion chamber | 23 |
| Code | 39 |
| Code 1 | 39 |
| Code 2 | 42 |
| Coding during commissioning | 27 |
| Comfort sensor | 87 |
| Commissioning | 7 |
| Condensate drain | 24 |
| Cylinder temperature sensor | 86 |
| D | |
| Declaration of Conformity | 127 |
| Deleting codes | 62 |
| E | |
| Extension kit for heating circuit with mixer | 94 |
| Extension | |
| ■ external | 102, 103 |
| ■ internal | 100, 101 |
| External blocking | 105 |
| External demand | 105 |
| F | |
| Fault history | 72 |
| Fault message | 74 |
| Fault messages | 72 |
| Filling function | 105 |
| Filling the system | 7 |
| Finding faults | 73 |
| Flow limiter | 25 |
| Flue gas temperature sensor | 89 |
| Function descriptions | 96 |
| Fuse | 93 |
| G | |
| Gas combination valve | 14 |
| Gas supply pressure | 15 |
| Gas type | 11 |
| H | |
| Heating curve | 34 |
| Heating curve slope | 35 |
| Heating surfaces | 23 |
| I | |
| Ignition | 22 |
| Ignition electrodes | 22 |
| Ionisation current | 26 |
| Ionisation electrode | 22 |
| L | |
| Language selection | 10 |
| Level | 35 |
| Level heating curve | 35 |
| LON communication module | 32 |
| LON system | 32 |
| LON user check | 33 |
| M | |
| Manufacturer's Declaration | 128 |
| O | |
| Operating mode changeover | 104 |
| Outlet temperature sensor | 87 |
| Outside temperature sensor | 84 |

Keyword index

Keyword index (cont.)

P

| | |
|-------------------------------|-----|
| Parts list | 113 |
| Plate heat exchanger | 91 |
| Product characteristics | 126 |

R

| | |
|---|----|
| Relay test | 68 |
| Resetting codes to the as delivered condition | 62 |

S

| | |
|--|---------------|
| Safety chain | 92 |
| Scanning | 64 |
| Scanning operating conditions | 69 |
| Scanning sensors | 69 |
| Scanning temperatures | 64 |
| Screed drying | 106 |
| Screed function | 106 |
| Service level summary | 63 |
| Service report | 120, 122, 124 |
| Setting the date | 11 |
| Setting the output | 18 |
| Setting the time | 11 |
| Setting up LON user numbers | 32 |
| Siphon | 10, 24 |
| Slope | 35 |
| Soundness test, balanced flue system | 19 |
| Specification | 126 |
| Static pressure | 14 |
| Supply pressure | 14 |
| System designs | 27, 40 |
| System pressure | 7 |

T

| | |
|---------------------------|----|
| Temperature limiter | 92 |
| Testing functions | 68 |

V

| | |
|-----------------------|-----|
| Venting | 9 |
| Venting program | 105 |
| Vitotronic 050 | 95 |

W

| | |
|----------------------|-----|
| Wiring diagram | 109 |
|----------------------|-----|

Applicability

Gas fired condensing boiler

Type WB2A

8.8 to 26 kW

from serial no.

7176 543 3 00001 ...

Gas fired condensing combination boiler

Type WB2A

8.8 to 26/28 kW

from serial no.

7176 541 3 00001 ...

Viessmann Limited

Hortonwood 30, Telford, TF1 7YP, GB

Telephone: +44 1952 675000

Fax: +44 1952 675040

www.viessmann.co.uk

Printed on environmentally-friendly,
chlorine-free bleached paper



5692 573 GB Subject to technical modifications