

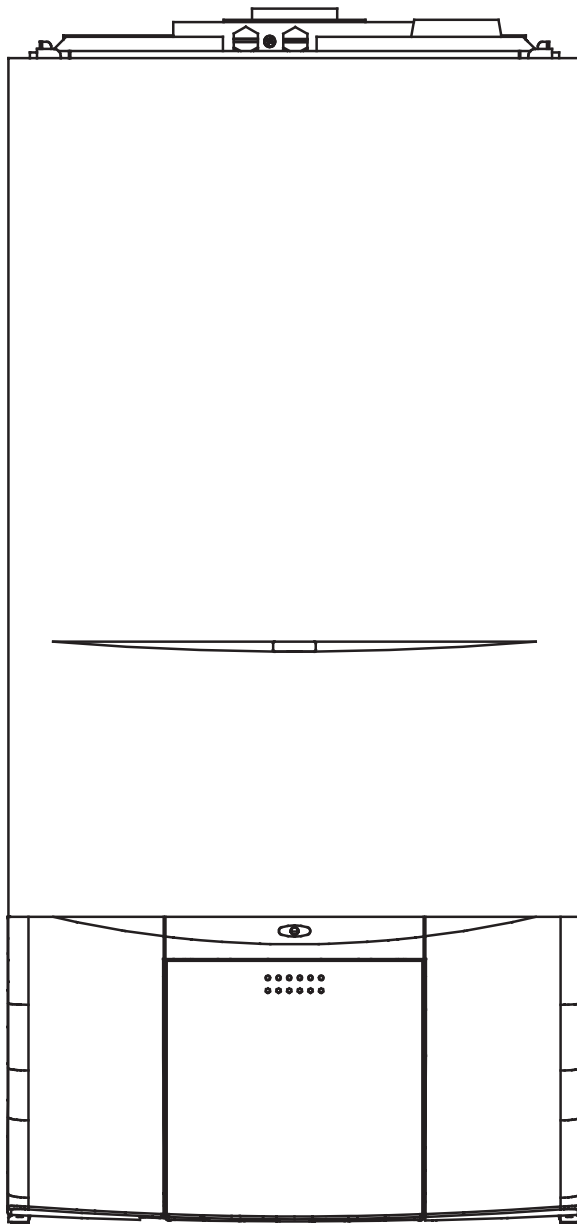

Synergy



Users Instructions



**THESE INSTRUCTIONS
TO BE RETAINED
BY USER**



*The code of practice for the installation,
commissioning & servicing of central heating systems*

Contents

Introduction	Page
Dear customer	2
Do's and don't's	2

Things you should know	Page
1.1 Gas appliances	3
1.2 Electrical supply	3
1.3 Guarantee registration card	3
1.4 Appliance log book	3
1.5 How does it work?	3
1.6 Additional features	3
1.7 Dimensions	3
1.8 Clearances required	3

Getting started	Page
2.1 Before switching on	4
2.2 Appliance controls	4
2.3 Lighting the boiler	4

How to...	Page
3.1 Top-up the system	4
3.2 Reset the appliance	4
3.3 Understand the diagnostic fault codes	5
3.4 Shut down the system for short periods	5
3.5 Shut down the system for long periods	5
3.6 Care for the appliance	5

What if...	Page
4.1 I suspect a gas leak	5
4.2 I frequently have to top-up the system	5
4.3 The status led is flashing red	5
4.4 The appliance is due its annual service	5
4.5 I need to call an engineer	5

Setting the Vokera	Page
5.1 Mechanical clock	6
5.2 Digital clock	6
5.3 Programmer	8

INTRODUCTION

Dear Customer

Your Synergy boiler has been designed to meet and exceed the very latest standards in gas central heating technology, and if cared for, will give years of reliable use and efficiency.

Please therefore take some time to read these instructions carefully.

Do's and don't's

- Do ensure that the system pressure is periodically checked
- Do ensure that you know how to isolate the appliance in an emergency
- Do ensure that you are familiar with the appliance controls
- Do ensure that your installer has completed the appliance log book
- Do not attempt to remove the appliance casing or gain internal access
- Do not hang clothes etc. over the appliance
- Do not forget to have the appliance serviced annually

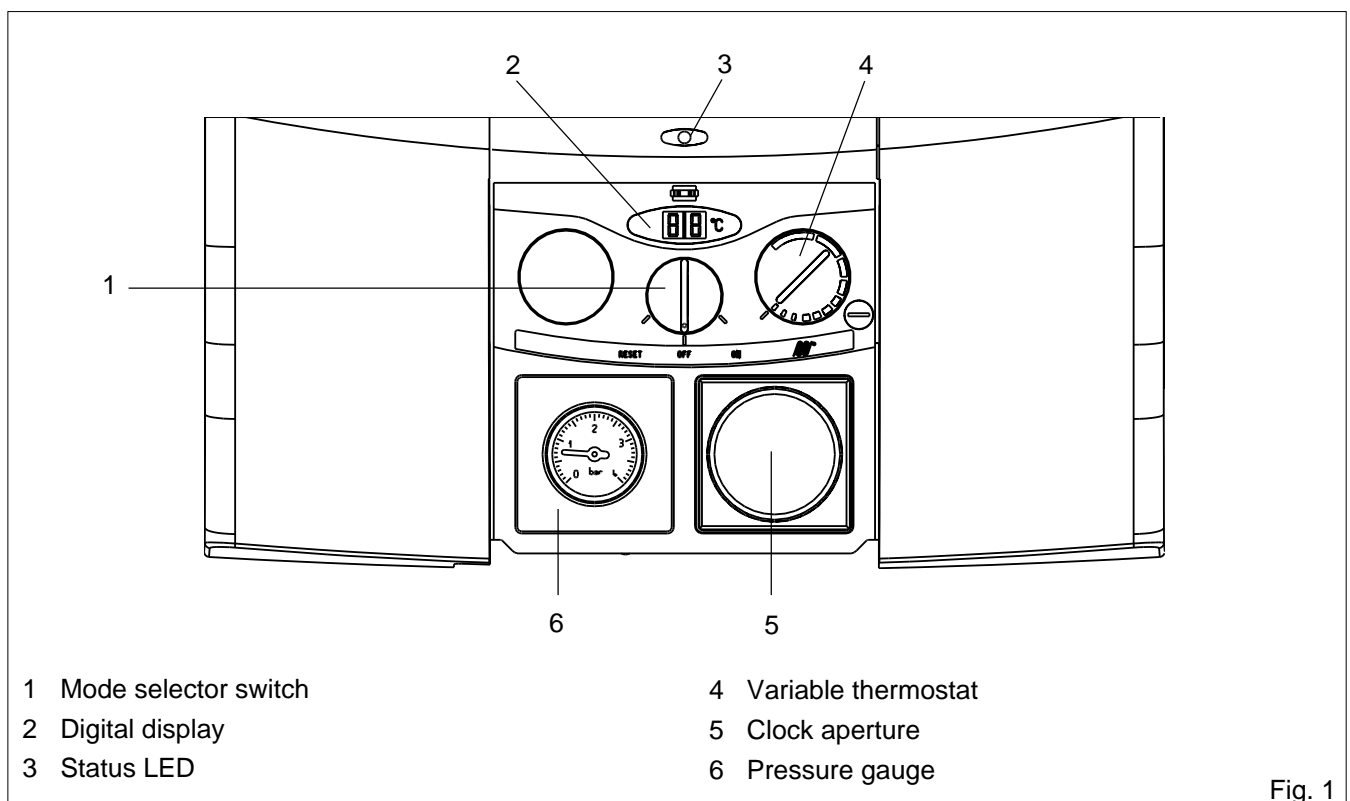

Fig. 1

THINGS YOU SHOULD KNOW

1.1 GAS APPLIANCE

Gas Safety (Installations and Use) Regulations. In the interests of your safety and that of the others it is a legal requirement that all gas appliances are installed and correctly maintained by a competent person and in accordance with the latest regulations.

1.2 ELECTRICAL SUPPLY

Please ensure that this appliance has been properly connected to the electrical supply by means of a double pole isolator or un-switched socket, and that the correct size of fuse (3 amp) has been fitted.

Warning: this appliance must be earthed!

1.3 GUARANTEE REGISTRATION CARD

Please take the time to fill out your guarantee registration card. The completed warranty card should be posted within 30 days of installation.

1.4 APPLIANCE LOG BOOK

A log book is supplied with the boiler. This important document must be completed during the installation/commissioning of your boiler. Failure to install and commission the appliance in accordance with the manufacturers instructions may invalidate the warranty. This does not affect your statutory rights.

1.5 HOW DOES IT WORK?

Your Synergy boiler is a central heating boiler, which supplies heated water to your radiators and hot water cylinder.

It is controlled by the time clock or programmer and any thermostats that your installer may have fitted.

The Synergy lights electronically and does not have a pilot light. In the unlikely event of a fault developing with your boiler, the supply of gas to the burner will be terminated automatically.

1.6 ADDITIONAL FEATURES

Your Synergy boiler includes some of the latest features that have been designed to ensure continued safety and reliability of the appliance. These include:

- appliance frost protection
- pump-spin
- diagnostic fault codes
- LED status indicator

FROST PROTECTION

Your Synergy will automatically operate to minimise the risk of frost damage to the boiler itself. The frost protection device will be disabled should the power supply to the boiler be disrupted.

PUMP-SPIN

When the boiler has not been used for more than 24 hours, the pump is energised for a few seconds

to ensure that it does not stick or jam. The pump-spin device will be disabled should the power supply to the boiler be disrupted.

DIAGNOSTIC FAULT CODES

In the unlikely event of a fault developing, the boiler displays a unique fault code that helps identify where the fault lies.

LED STATUS INDICATOR

The Synergy is equipped with a LED status indicator that gives a visual indication of whether the boiler is working normally or has developed a fault.

1.7 DIMENSIONS

	29
HEIGHT	820 mm
WIDTH	450 mm
DEPTH	350 mm

1.8 CLEARANCES REQUIRED

ABOVE	150 mm
BELOW	150 mm
SIDES	12 mm
FRONT	600 mm

GETTING STARTED

2.1 BEFORE SWITCHING ON

Before switching the appliance on, please familiarise yourself with:

- how to isolate the appliance from the gas, water and electricity supplies
- how to check and top-up - if necessary - the system water pressure
- the time clock or programmer
- any external thermostats and their functions
- the appliance controls.

2.2 APPLIANCE CONTROLS (see fig. 1)

The appliance controls are concealed behind the front flap. To gain access to the controls simply press the top centre of the flap, release, and pull downward. The appliance has a mode switch, variable thermostat, system pressure gauge, and an aperture for an integral clock or programmer. The mode switch has three positions:

- RESET
- OFF
- ON

The variable thermostat allows you to set the temperature of the water to your radiators and hot water cylinder (not the hot water to your taps!) between 40°C (min) and 80°C (max).

The pressure gauge shows the current pressure of the system, the gauge should be set between 1 and 1.5 bar. When the appliance is operating the gauge may rise or fall slightly, this is quite normal. The minimum permissible level for the safe and efficient operation of the appliance is 0.5 bar. Should the pressure fall below 0.5 bar, the boiler shuts off automatically.

Depending on the type of controls specified by your installer you may have an integral Vokera

time clock or programmer fitted to the appliance, if so, instructions can be found on page 6. If an external time clock or programmer has been fitted, please refer to the instructions supplied with such.

2.3 LIGHTING THE BOILER

Ensure the gas and electrical supply to the boiler are turned on.

Turn the mode switch to the “on” position. The status indicator should be “green” if the status indicator is flashing “red” refer to 3.2.

Refer to the particular instructions for the type of programmer or time clock fitted and ensure there is a demand for heating and/or hot water. If there is a room thermostat and/or hot water cylinder thermostat you should ensure these are also calling for heat.

When there is a demand for heating and/or hot water via the above controls, the boiler will go through an ignition sequence, whereby the burner will light.

If the appliance fails to ignite during the ignition sequence, allow a period of two minutes before re-setting.

To adjust the output temperature of the appliance turn the thermostat knob clockwise to increase or anti-clockwise to decrease.

When the appliance reaches the set temperature, the burner will go off for minimum period of approximately 3 minutes.

When the programmer/time clock or external thermostats heating request has been satisfied, the appliance will switch off automatically.

HOW TO...

3.1 HOW TO TOP-UP THE SYSTEM PRESSURE (see fig. 2)

The system pressure must be checked periodically to ensure the correct operation of the boiler. The needle on the gauge should be reading between 1 and 1.5 bar when the boiler is in an off position and has cooled to room temperature. If the pressure requires ‘topping-up’ use the following instructions as a guide.

- Locate the filling valve connections (external to the boiler).
- Attach the filling loop to both connections.
- Open the filling valve slowly until you hear water entering the system.
- Close the filling valve when the pressure gauge (on the boiler) reads between 1 and 1.5 bar.
- Remove the filling loop from the connections.

3.2 HOW TO RESET THE APPLIANCE

When the led status indicator is flashing red, the appliance will require to be reset manually. Using the mode switch, turn it two clicks to the left (reset position) then slowly turn it back to the “on” position (see also 3.3). Allow a period of two minutes to elapse before turning the mode switch to the reset position.

IMPORTANT

If the appliance requires to be reset frequently, it may be indicative of a fault, please contact your installer or Vokera Customer Services for further advice.

3.3 DIAGNOSTIC FAULT CODES

Display shows	Action required
01	Burner has failed to ignite. Ensure gas meter is turned on. Wait two minutes before resetting. If problem persists call engineer.
02	Boiler has overheated, wait 5 minutes for boiler to cool. Reset boiler. If problem persists call engineer.
03	Flue problem. Call engineer.
04	Low water pressure. Ensure pressure gauge is above 0,5 bar (see 3.1). Reset boiler.
05	Boiler fault. Call engineer.
06	Boiler fault. Call engineer.
07	Boiler fault. Call engineer.
08	Boiler fault. Call engineer.
09	Boiler fault. Call engineer.
d1 & d2	Problem with condense trap/pipe/sensor. Call engineer.

3.4 HOW TO SHUT DOWN THE SYSTEM FOR SHORT PERIODS

The system and boiler can be shut down for short periods by simply turning the programmer or time clock to the off position (see page 6 or the instructions supplied). It is also advisable to turn off the main water supply to the house.

3.5 HOW TO SHUT DOWN THE SYSTEM FOR LONG PERIODS

If the house is to be left unoccupied for any length of time – especially during the winter – the system should be thoroughly drained of all water. The gas, water and electricity supply to the house should also be turned off. For more detailed advice contact your installer.

3.6 HOW TO CARE FOR THE APPLIANCE

To clean the outer casing use only a clean damp cloth. Do not use any scourers or abrasive cleaners.

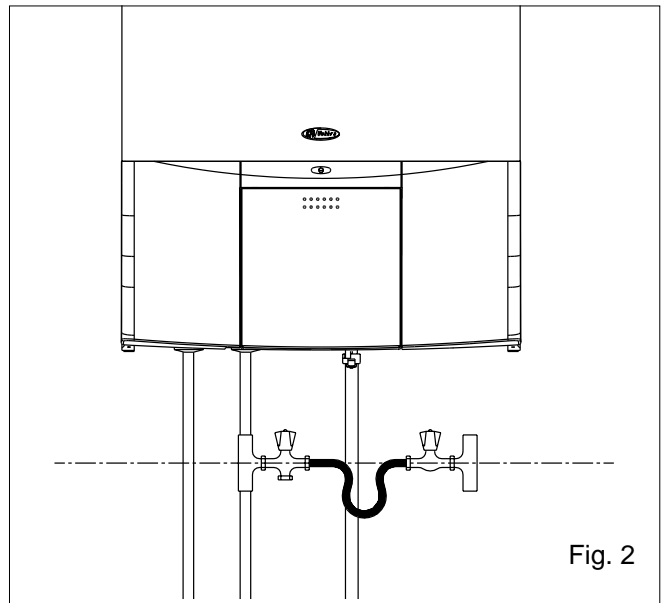

WHAT IF...

4.1 WHAT IF I SUSPECT A GAS LEAK

If you suspect a gas leak, turn off the gas supply at the gas meter, and contact your installer or local gas supplier. If you require further advice please contact your nearest Vokera office.

4.2 WHAT IF I HAVE TO FREQUENTLY TOP-UP THE SYSTEM

If the system regularly requires topping-up, it may be indicative of a leak. Please contact your installer and ask him to inspect the system.

4.3 WHAT IF THE STATUS LED IS FLASHING RED

If the red led is flashing it indicates that the boiler or system has developed a problem, when this happens the boiler automatically shuts down and requires to be reset manually (see 3.2).

4.4 WHAT IF THE APPLIANCE IS DUE ITS ANNUAL SERVICE

Advice for tenants only

Your landlord should arrange for servicing.

Advice for homeowners

Please contact Vokera Customer Services (**0870 333 0220 (UK) or 05655057 (ROI)**) if you would prefer a Vokera service engineer or agent to service your appliance. Alternatively your local CORGI registered engineer may be able to service the appliance for you.

4.5 WHAT IF I NEED TO CALL AN ENGINEER

If you think your boiler may have developed a fault please contact your installer or Vokera Customer Services (**0870 333 0220 (UK) or 05655057 (ROI)**) have all your details to hand including full address and postcode, relevant contact numbers, and your completed appliance log book.

VOKERA TIMECLOCKS

5.1 SETTING THE MECHANICAL CLOCK

The Vokera mechanical time clock can automatically switch your boiler on and off at the same time every day of the week. The minimum 'on' or 'off' period can be as little as 15 minutes. The outer clock face consists of 96 black pins. Each pin represents a time period of fifteen minutes. When a pin is pushed towards the outside of the clock face, the time clock is in an 'on' position, consequently when it is pushed towards the inner part of the clock face it is in an 'off' position.

5.1.1 SETTING THE 'ON' & 'OFF' TIMES

Push the necessary amount of pins towards the outer clock face for the time period that you want the boiler to be 'on' (for example if you wanted the boiler to be on between 4.00PM and 8.00PM, push out the 16 pins located between 16 and 20 on the clock face).

5.1.2 SETTING THE 'TIME OF DAY'

Grasp the outer clock face and turn clock-wise until the correct 'time of day' is opposite the black pointer.

5.1.3 SELECTOR SWITCH

The time clock has a three-position switch. This switch over-rides the timed settings ('on' & 'off' times) of the clock.

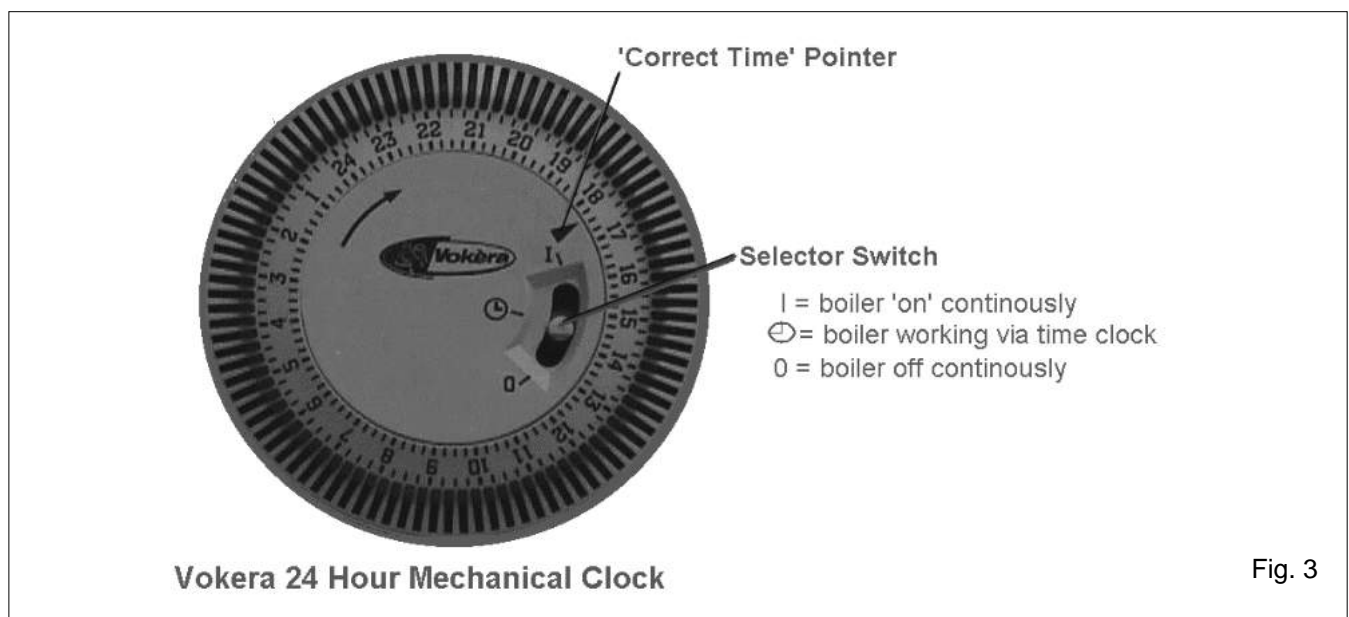

VOKERA PROGRAMMERS

5.2 SETTING THE DIGITAL CLOCK

The Vokera digital time clock will automatically switch your boiler on and off. It has a total of twenty different switching commands, consisting of ten 'on' commands and ten 'off' commands. Each 'on' or 'off' command can be used to switch the boiler 'on' or 'off' at the same time:

- every day of the week
- Monday to Saturday
- Monday to Friday
- Saturday and Sunday
- any particular day.

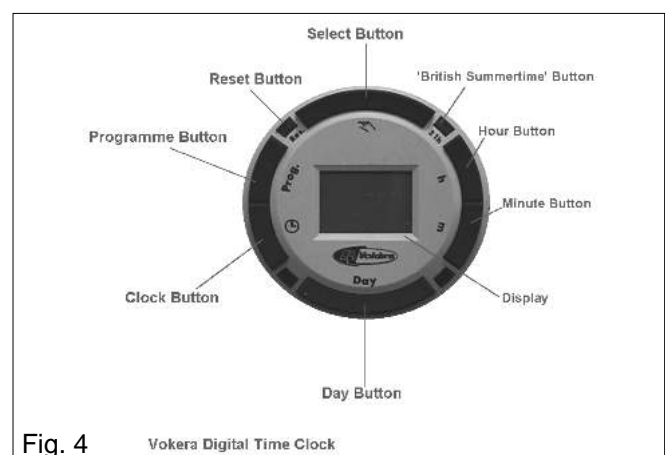

Example



Group of days	On	Off	Commands used
Mon. to Fri.	06.00	09.00	2
Mon. to Fri.	16.00	21.00	2
Sat. & Sun.	08.30	10.30	2
Sat. & Sun.	17.00	23.00	2
		Total	8 used
Commands 'free'			12 unused

5.2.1 BEFORE PROGRAMMING

Gently press and release the 'Res.' button with a pencil or similar, this will clear the memory of all information. This should only be done when you want to change or insert a complete new programme.

5.2.2 SETTING THE TIME OF DAY

The 'real time' clock has to be set to the actual day of the week and time of day, to do this:

- press and hold the  button (see fig. 6).
- press the 'Day' button until the actual day shows in the display (1= Monday, 2= Tuesday, 3= Wednesday, etc.).
- if setting the clock during 'British summertime' press the '+/-1h' button once (use a pencil or similar).
- press the 'h' button until the actual hour is shown in the display.
- press the 'm' button until the actual minutes are showing in the display.
- now release the  button.
- the ':' symbol between the hours and minutes display will start to flash, this indicates that the clock is now keeping time (see fig. 6).

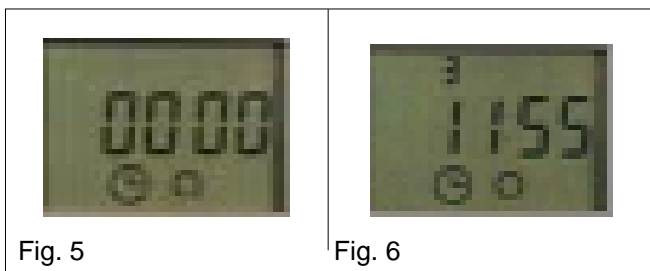



Fig. 5

Fig. 6

5.2.3 ENTERING (on) COMMANDS

- Repeatedly press the Prog. Button until the — :— symbol appears in the clock display (see fig. 7).
- Press the Day button until the desired group of days or desired day is shown.
- Press the 'h' button until the desired hour for switching the boiler on is shown.
- Press the 'm' button until the desired minutes are shown.
- Press the Select button until the  symbol is shown (see fig. 8).
- Press the  button.

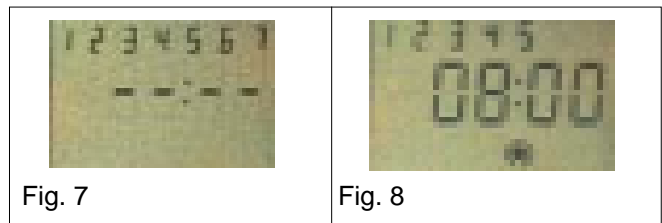





Fig. 7

Fig. 8





5.2.4 ENTERING (off) COMMANDS

- Repeatedly press the Prog. Button until the — :— symbol appears in the clock display (fig. 7).
- Press the Day button until the desired group of days or desired day is shown.
- Press the 'h' button until the desired hour for switching the boiler off is shown.
- Press the 'm' button until the desired minutes are shown.
- Press the Select button until the  symbol is shown (see fig. 9).
- Press the  button.

Once the programming has been completed you will have to press the Select button – once only – to the  (on) position if the boiler has been programmed to be 'on' at that particular time.

5.2.5 ADVANCING OR LOCKING PROGRAMME COMMANDS

By pressing the Select button you can advance the time clock to the next command setting (from 'on' to 'off' or 'off' to 'on') or lock the time clock to a particular command ('on' continuously or 'off' continuously).

-  - ON
-  - OFF
- [] – ON CONTINUOUSLY
- [] – OFF CONTINUOUSLY

NOTE

The actual time can be changed to account for British summertime by simply pressing then releasing the +/- 1h button.

HELPFUL HINTS

- You can check and/or alter the programme settings at any time by pressing the Prog button.
- The number of unused 'commands' can be checked by pressing the Prog button until FR is displayed alongside the number of unused commands.
- In the event of a power failure, the clock has a battery back-up. The programme will be held in the memory for approximately 2 weeks. Charging time is 70 hours.
- Take a note of the settings you have programmed, as local power surges can sometimes reset the memory of the clock.

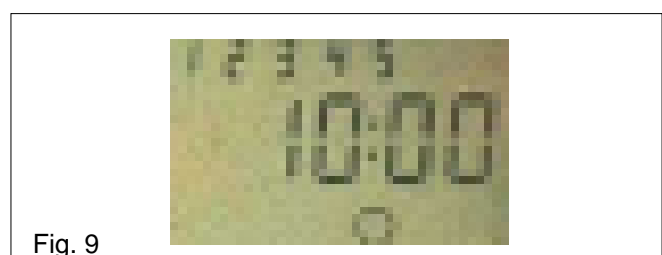

Fig. 9

SETTING INSTRUCTIONS FOR THE VOKERA 7 DAY 2 CHANNEL PROGRAMMER

The Vokera 2 channel 7 day programmer will automatically switch your central heating system ON and OFF once, twice or three times a day, whichever you wish and at whatever times you choose each day of the week.

It incorporates a rechargeable battery back-up system to protect the programme during power cuts of up to 24 hours, even though display will go blank.

The clock in the programmer has to be set to the actual day of the week and time of day.

It must then be told at what times you want it to switch your Central Heating (CH) and Hot Water (HW) system ON and OFF for each day of the week. This set of switching times is known as a programme.

The programmer has an in-built programme of standard switching times. They may well be right for you, but if they are not exactly what you want you can change them.

The standard programme is shown in the table on the following page, and, for simplicity, the switching operations are described as ON1, OFF1, ON2, OFF2, ON3, OFF3 from now on.

SETTING THE CLOCK

Use the chart to plan your own programme before proceeding.

Switch on the mains supply to the boiler, then switch the mode selector switch (1) ON. Press and release the button marked SET.

The display will show

SET
CLOCK ?

Press and release the button marked YES to answer the question and the day part of the display will flash. Use + and - buttons to change to the correct day then press SET again.

This will cause the hour part of the display to flash. Use the + and - buttons to change to the correct hour (check AM or PM) then press SET again. This will cause the minutes part of the display to flash. Again use the + and - buttons to change the minutes as required, then press SET again.

The display will now show

SET
PROG ?

(see later instructions for changing your programme).

Press the SET again

The display will now show

TEST ?

(again see later instructions)

Press the SET button again.

The display will show

SET
H'DAY ?

(again see later instructions about this holiday setting feature). Press SET once again and the display will show actual time of day and day of the week you have set.

PROGRAMME TEST

As described earlier, there is a place in the programming sequence where you will be given the opportunity to press YES when the display shows TEST ? This feature is available so you can quickly run through the ON and OFF times set to make sure they are what you want.

Answer YES and the display will show a time just past midnight on the morning of the day of the week you are actually in. Now press and hold down the YES button again. The time display will start to "run" and will pause for 2-3 seconds when it reaches the ON1 time for that day, the ON indicator light will be energised as will the circuit being controlled. If you release the YES button the display will stop running and give you more than 2-3 seconds to think about a switching time.

Continue pressing YES and the display will now "run" to the OFF1 time when it will pause again and the time switch will switch off. It will then "run" to the ON and OFF times in turn, pausing at each before moving to the next day and identifying the ON and OFF times in the same way.

The programmer will continue identifying the ON and OFF times in this way for each day in sequence until you press the SET button when it changes to the holiday setting mode. Pressing SET button again returns the module to normal operating mode.

HOLIDAY SETTING

NOTE: This useful feature allows you to set the number of days you want your system to be permanently off before automatically switching on at the programmed time.

The programmer counts each pass through mid-night as one day, so if on Saturday morning you don't want the system on again until Tuesday morning you set the counter to 3. If when the display shows SETH'DAY ? you press the YES button the display will show OO. By using the + and - buttons you can now set the number of days you want the system to be off, a maximum of 99 days is possible.

Now press SET again and the display will be blank apart from H'DAY. Having counted down to zero, the programmer will switch the system on at the times set for that day. If you wish to cancel the H'DAY setting, press any button and normal operation will be resumed. Your module is now in the operating mode and ready to work using the built-in standard programme times.

PROGRAMME OPTIONS

Hot water and central heating can be operated independantly.

The programmer gives you 4 options for both CH and HW:

OFF - Off all the time

TIMED - On/Off at all periods set in programme

ONCE - On for one period each day (ON1 >> OFF3)

ON - On all the time

Obtain the options you require by using the **SELECT** buttons to move the arrows in the display to the appropriate positions. Your module is now working using the standard programme times. If these suit your needs there is nothing else to do.

You can temporarily override the normal switching times by pushing a button marked **ADVANCE**. This switches **ON** to **OFF** as you require, but the normal programme switching times will not be permanently affected. If you want to make changes to the programme, it is suggested you write them down before making the changes.

CHANGING YOUR PROGRAMME

With the module in the operating mode and the display showing the actual time of day, press the **SET** button. The display will again show **SET CLOCK ?** but this has already been done so push the **SET** button again. The display will again show **SET PROG ?** and as it is the programme settings which are to be changed press the **YES** button.

The display will show



NOTE: The grouping of days in this way is to enable timings which apply to each and all of the weekdays to be set first, followed by the opportunity to change one or more timings for any single day.

If you wish to set timings which will be the same for each weekday press the **YES** button.

The display will show



press **YES** and make the changes or press **SET** if no changes are required.

The display will now show



press **YES** to make changes or **SET** if no changes are required.

The display will now show



press **YES** if you wish to make changes to Monday timings or press **SET** to change the display to **SET TUE PROG ?** Again press **YES** to make changes to Tuesday timings or continue to operate the **SET** button to access each weekday in turn.

If you press **YES** to make changes to the settings for a particular day, the display will firstly show **SET CH**

Press **YES** will allow changes to be made to the central heating settings, but pressing **SET** will cause the display to show **SET HW** Press **YES** will allow the changes to be made to the hot water settings, a further press of **SET** will move the display on the next day.

After any Friday changes have been made press **SET** The display will show



This gives you the chance to set timings which will apply to both weekend days by answering **YES**. Further operation of the **SET** button accesses **SAT** and **SUN** for individual timing changes.

Pressing **SET** after finishing any weekend programme changes, or pressing **SET** in answer to **SET PROG ?** returns the module to **TEST ?** Pressing **SET** again display **SET HOL ?** Pressing **SET** again returns the module to the normal operating mode.

If you answer **YES** to any of the detailed programming questions the following steps will apply.

The display will show the time set for the first switch on (**ON1**) to occur for the day(s) concerned. This can be altered in steps of 10 minutes by use of the **+** and **-** buttons. When the display is showing the time you want, press **SET** and the **OFF1** time will be seen.

Again changes may be made with the **+** and **-** buttons before pressing **SET** to show the time for **ON2** to occur. After making any adjustments press **SET** again to get the **OFF2** time displayed. Repeat this operation for the **ON3** and **OFF3** settings. This may be set up to 23 hours 50 minutes after the first switch on time.

Further operations of the **SET** button will take you through any remaining days of the week to be programmed before arriving at the operating mode and ready to work at the times you have set.

SWITCHING	MONDAY - FRIDAY		SATURDAY - SUNDAY	
	H/W	C/H	H/W	C/H
ON1-Start of first timed period of day (ON)	6.30am	6.30am	6.30am	6.30am
OFF1-End of first timed period (OFF)	8.30am	8.30am	9.00am	9.00am
ON2-Start of second timed period (ON)	12 noon	12 noon	12 noon	12 noon
OFF2-End of second period (OFF)	12 noon	12 noon	12 noon	12 noon
ON3-Start of third period (ON)	4.30pm	4.30pm	4.00pm	4.00pm
OFF3-Final switch 'OFF'	10.30pm	10.30pm	11.00pm	11.00pm

HELPFUL HINTS

1. The **+** and **-** buttons are used to change times. Press and release for small changes; press and hold down and the time will 'run'.
2. You cannot set the first switch on time (**ON1**) before mid-night but you can set the **OFF3** after midnight so long as you don't try to exceed 23 hour 50 mins after **ON1**.
3. The switching times have to be in sequence (**ON1, OFF1, ON2, OFF2, ON3** and **OFF3**) if you try to set **OFF1** earlier than **ON1** the display will stop at the **ON1** time with the **OFF** symbol flashing. The same thing will happen with other switching times e.g. between **OFF1** and **ON2**, this time the **ON** symbol will flash.
4. If you attempt to set the **ON1** after the **OFF1** time, the **ON** symbol will flash and the **OFF1** setting will follow the **ON1** time being set to prevent incorrect programming. The same feature applies with the other **ON** and **OFF** times and also between the **OFF** and **ON** times.
5. To use only two switching per day set the **ON2 & OFF2** times both to 12.00
6. If you get confused and wish to start the whole programming procedure again, press the **SET** and **+** buttons together for a moment. The module will revert to a mid-night time display and the built-in standard programme. You will now have to set the clock again and then enter the programme you want.
7. When you are making adjustments to timings, if no button is pressed for 1 to 2 minutes, the module will automatically revert to the normal operating mode.
8. To shut the **CH** down for the Summer simply select the **OFF** option by means of the **CH SELECT** button.

SETTING INSTRUCTIONS FOR THE VOKERA 24HR 2 CHANNEL PROGRAMMER

The Vokera 2 channel 24hr programmer will automatically switch your central heating system ON and OFF once or twice a day, whichever you wish and at whatever times you choose. You also have the option to obtain continuous ON or OFF operation.

It incorporates a rechargeable battery back-up system to protect the programme during power cuts of up to 24 hours, even though display will go blank.

The clock in the programmer has to be set to the actual time of day.

It must then be told at what times you want it to switch your Central Heating (**CH**) and Hot Water (**HW**) system **ON** and **OFF**. This set of switching times is known as a programme.

The programmer has an in-built programme of standard switching times. They may well be right for you, but if they are not exactly what you want you can change them.

The standard programme is shown in the table overleaf, and, for simplicity, the switching operations are described as **ON1, OFF1, ON2, OFF2** from now on.

SETTING THE CLOCK

Use the chart overleaf to plan your own programme before proceeding.

Switch on the mains supply to the boiler, then switch the mode selector switch ON. Press and release the button marked **SET**.

The display will show

SET CLOCK ?

Press and release the button marked **YES** to answer the question and the hour part of the display will flash. Use the **+** and **-** buttons to change to the correct hour (check AM or PM) then press **SET** again.

This will cause the minutes part of the display to flash. Use the **+** and **-** buttons to change the minutes as required, then press **SET** again.

The display will now show

SET PROG ?

(see later instructions for changing your programme).

Press the **SET** button again and the display will now show the time of day you have set.

Your programmer is now in the operating mode and ready to work using the built-in standard programme times.

CHANGING YOUR PROGRAMME

With the module in the operating mode and the display showing the actual time of day, press the **SET** button. The display will again show **SET CLOCK ?** but this has already been done so push the **SET** button again.

The display will now show **SET PROG ?** and as it is the programme settings which are to be changed press the **YES** button.

The display will show

SET CH PROG ?

NOTE: If you wish to make changes to the ON or OFF timings for CH you press the yes button, if not you press the **SET** button again and this will change the display question to **SET HW PROG ?**.

Again you have to answer the question either with the **YES** button or by pressing the **SET** button which returns the programmer to the normal operating mode with the time of day displayed.

If you answer **YES** to **SET CH PROG ?** the display will show the time set for the first **CH ON** (**ON1**). This can be altered in steps of 10 minutes by the use of the **+** & **-** buttons. When the display is showing the time you want, press **SET** and the **CH OFF** (**OFF1**) time will be seen.

Again changes can be made using the **+** & **-** buttons before pressing **SET** to display the time for **CH ON** (**ON2**). After making any adjustments press **SET** again to get the **CH OFF** (**OFF2**) time displayed. This may be adjusted up to 23hrs & 50 mins. after the first switch on time.

Press the **SET** button again and the question **SET HW PROG ?** will be displayed.

SET HW PROG ?

By answering **YES**, the same procedure can be followed for adjusting the HW timings before pressing **SET** one final time to go back to the time of day.

HELPFUL HINTS

1. The **+** and **-** buttons are used to change times. Press and release for small changes; press and hold down and the time will 'run'.
2. You cannot set the first switch on time (**ON1**) before mid-night but you can set the (**OFF2**) after midnight so long as you don't try to exceed 23 hour 50 mins after (**ON1**).
3. The four switching times have to be in sequence (**ON1**, **OFF1**, **ON2**, **OFF2**) if you try to set **OFF1** earlier than **ON1** the display will stop at the **ON1** time with the **OFF** symbol flashing. The same thing will happen with other switching times e.g. between **OFF1** and **ON2**, this time the **ON** symbol will flash.
4. If you attempt to set the **ON1** after the **OFF1** time, the **ON** symbol will flash and the **OFF1** setting will follow the **ON1** time being set to prevent incorrect programming. The same feature applies with the other **ON** and **OFF** times and also between the **OFF** and **ON** times.
5. If you get confused and wish to start the whole programming procedure again, press the **SET** and **+** buttons together for a moment. The module will revert to a mid-night time display and the built-in standard programme. You will now have to set the clock again and then enter the programme you want.

6. When you are making adjustments to timings, if no button is pressed for 1 to 2 minutes, the module will automatically revert to the normal operating mode.
7. To shut the **CH** down for the Summer simply select the **OFF** option by means of the **CH SELECT** button.

PROGRAMMER OPTIONS

Hot water and central heating can be operated independently.

The programmer gives you 4 options for both CH & HW:

OFF - Off all the time.

TIMED - On/Off at all periods set in programme.

ONCE - On for one period each day (**ON1** > **OFF2**).

ON - On all the time.

Obtain the options you require by using the **SELECT** buttons for CH & HW to move the arrows in the display to the appropriate position.

Press the **SET** button again and the question **SET HW PROG ?** will be displayed.

SWITCHING	STANDARD PROG.	
	H/W	C/H
ON 1 - Start of first timed period of day (ON)	6.30am	6.30am
OFF 1 - End of first timed period (OFF)	8.30am	8.30am
ON 2 - Start of second timed period (ON)	4.30pm	4.30pm
OFF 2 - Final switch (OFF)	10.30pm	10.30pm

STANDARD PROGRAM FOR 24HR 2 CHANNEL PROGRAMMER



Vokèra Ltd.

4th Floor, Catherine House, Boundary Way, Hemel Hempstead, Herts, HP2 7RP

Email: enquiries@vokera.co.uk Web: www.vokera.co.uk

Sales, Technical Advice, General Enquiries - Tel: 0870 333 0520 Fax: 01442 281460

After Sales Service - Tel: 0870 333 0220

Vokèra Ireland

West Court, Callan, Co Kilkenny

Tel: 056 55057 Fax: 056 55060

Vokèra Ltd. reserve the right to change the specifications without prior notice. Consumers' statutory rights are not affected.

A Riello Group Company



**"Vokèra"
supports Benchmark**