

VIBE MAX

High efficiency combi boiler

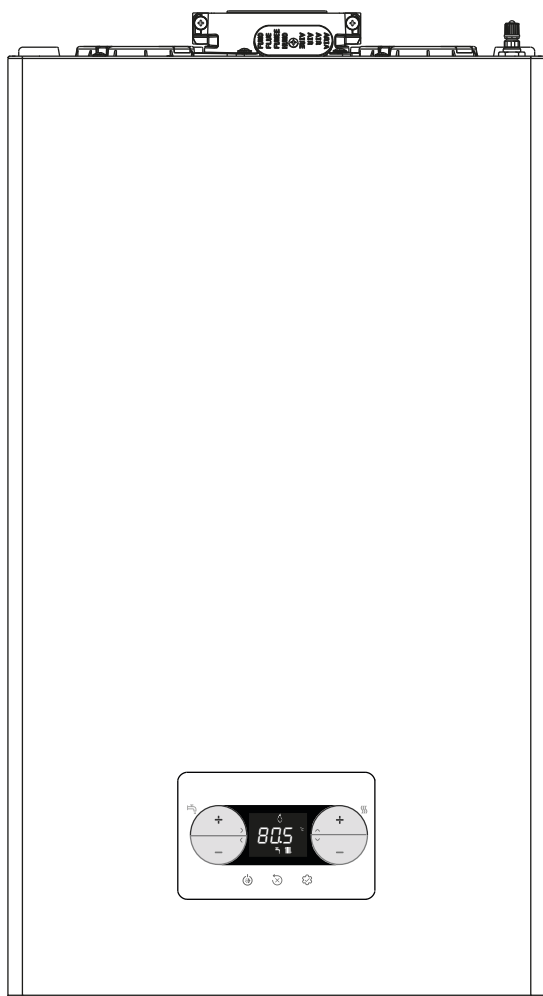

Users Instructions

Installation & Servicing Instructions



VIBE MAX 26C G.C. N° 47-364-69
VIBE MAX 30C G.C. N° 47-364-70

THESE INSTRUCTIONS
TO BE RETAINED
BY USER



Vokèra is a licensed member of the Benchmark scheme which aims to improve the standards of installation and commissioning of domestic hot water systems in the UK.

1. THINGS YOU SHOULD KNOW.....	2	SECTION 7 - WIRING DIAGRAMS	36
2. GETTING STARTED.....	5	SECTION 8 - LPG INSTRUCTIONS.....	39
3. WHAT IF.....	8	Commissioning checklist	40
SECTION 1 - DESIGN PRINCIPLES AND OPERATING SEQUENCE	10	Benchmark	41-44
SECTION 2 - TECHNICAL DATA	11	Vokèra Warranty Terms and Conditions.....	45-46
SECTION 3 - GENERAL REQUIREMENTS (UK)	14		
SECTION 3A - GENERAL REQUIREMENTS (EIRE).....	15		
SECTION 4 - INSTALLATION	17		
SECTION 5 - COMMISSIONING & OPERATION.....	21		
SECTION 6 - SERVICING INSTRUCTIONS.....	35		

RANGE RATED

This boiler can be adapted to the heat requirements of the system, and in fact it is possible to set the range rated parameter as shown in the specific paragraph.
After setting the desired output report the value in the table on the back cover of this manual, for future references.

USERS INSTRUCTIONS

INTRODUCTION

Dear Customer

Your Vokèra **VIBE MAX** boiler has been designed to meet and exceed the very latest standards in gas central heating technology, and if cared for, will give years of reliable use and efficiency. Please therefore take some time to read these instructions carefully.

Do's and Don't's

- **Do** ensure that the system pressure is periodically checked
- **Do** ensure that the boiler should not be used by children or unassisted disabled people
- Do ensure that you know how to isolate the appliance in an emergency
- **Do** ensure that you are familiar with the appliance controls
- **Do** ensure that your installer has completed the appliance log book section
- **Do not** attempt to remove the appliance casing or gain internal access
- **Do not** hang clothes etc. over the appliance
- **Do not** forget to have the appliance serviced annually.

This booklet is an integral part of the appliance. It is therefore necessary to ensure that the booklet is handed to the person responsible for the property in which the appliance is located/installed. A replacement copy can be obtained from the Vokera website.



At the end of its life, the product should not be disposed of as solid urban waste, but rather it should be handed over to a differentiated waste collection and/or recycling centre.

1. THINGS YOU SHOULD KNOW

1.1 GAS APPLIANCES

Gas Safety (Installation and Use) Regulation (UK).

In the interests of your safety and that of others it is a legal requirement that all gas appliances are installed and correctly maintained by a competent person and in accordance with the latest regulations.

1.2 ELECTRICAL SUPPLY

Please ensure that this appliance has been properly connected to the electrical supply by means of a double pole isolator or un-switched socket, and that the correct size of fuse (3 AMP) has been fitted.

Warning: this appliance must be earthed!

1.3 WARRANTY REGISTRATION

Please take the time to register the appliance warranty using the documentation provided, call 0800 479 0751 (UK) or register online at www.vokera.ie to obtain your warranty confirmation code (please have your appliance warranty card to hand).

1.4 APPLIANCE COMMISSIONING CHECKLIST (UK only)

The Benchmark checklist section can be found at the rear of the appliance installation booklet. This important document must be completed during the installation/commissioning of your boiler. All GAS SAFE registered installers carry a GAS SAFE ID card, and have a registration number. These details should be recorded in the Benchmark commissioning checklist section within the installation booklet. You can check your installers details by calling GAS SAFE direct on 08004085500. Failure to install and commission the appliance in accordance with the manufacturers instructions will invalidate the warranty. This does not affect your statutory rights.

1.5 HOW DOES IT WORK?

Your **VIBE MAX** boiler supplies heated water to your radiators and hot water to your hot water taps. The central heating is controlled via a time clock and any thermostats that your installer may have fitted. The boiler will light when it receives a request from the time clock via any thermostat that may be installed, or whenever a hot water outlet (tap) is opened. Your **VIBE MAX** boiler lights electronically and does not have a pilot light. In the unlikely event of a fault developing with your boiler, the supply of gas to the burner will be terminated automatically.

1.6 DIMENSIONS

	HEIGHT	WIDTH	DEPTH
26C-30C	700 mm	400 mm	275 mm

1.7 CLEARANCES REQUIRED

ABOVE	165mm*
BELOW	150mm^
LEFT SIDE	2mm**
RIGHT SIDE	2mm**
FRONT	4mm***

* Consideration should be given to providing reasonable clearance for the insertion of a FGA probe.

** Disconnection of adjacent components may be required. Alternatively allow 25mm clearance for removal of side panels.

*** Provided that a door or removal panel enables 450mm access for maintenance.

^ Can be reduced to 5mm if a removal panel enables 150mm for maintenance.

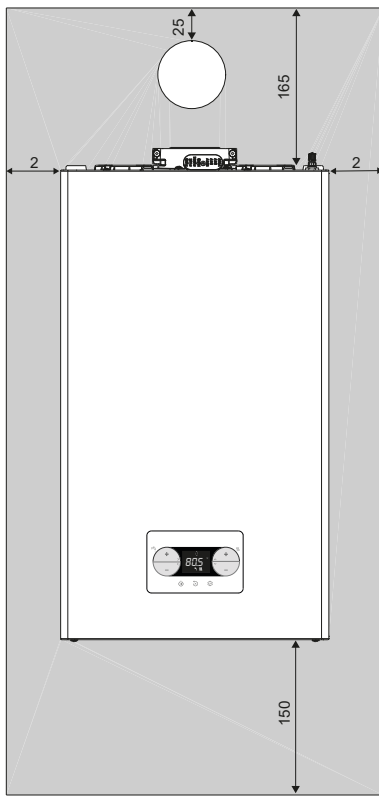

1.8 FROST PROTECTION SYSTEM

The **VIBE MAX** is equipped with a built-in frost protection system, this enables the boiler to over-ride the time controls – even if switched off – and operate the burner and/or pump, should the temperature drop below 5°C for the main and for the DHW line. In particular the burner will be in ON status until the appliance temperature reaches 35°C for CH appliance and 55°C for DHW appliance. Please note that the frost protection system is designed to protect the appliance only, should frost protection be required for the heating system, additional controls may be required.

NOTE: the frost protection system is reliant on the appliance having a permanent electrical supply, and being in a non-fault condition.

1.9 CONTROL PANEL

Your boiler is equipped with a large LCD display that indicates the appliance operating status.

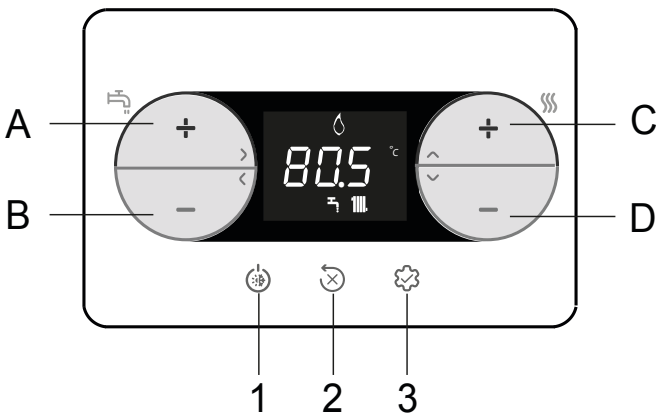

Note: values in thousands are displayed/100, for example 6500 rpm = 65.0

A and B	DHW setpoint adjustment Parameter selection
C and D	Heating setpoint adjustment Parameter setting
A+B	DHW Comfort menu (on the main page and with a status other than OFF)
B	Return to previous screen/cancel choice Press >2 sec to return to main page
1	Change operating status (OFF, SUMMER and WINTER)
2	Reset alarm (RESET) Interrupt venting cycle
3	Access to INFO menu Access to parameter setting menu Access to password entry page ENTER function
1+3	Key lock/unlock
2+3	When the boiler is OFF, activates combustion analysis (CO)

	Connection to a WIFI device
	Fault or deadline timer call for service
	In the event of a fault together with the icon (apart from flame and water alarms)
	Indicates presence of flame. In the event of a flame failure, the icon is
	Flashes with temporary water alarms, fixed with permanent alarm
	Present if heating mode is active; flashes with heating request in progress
	Present if DHW mode is active; flashes with DHW request in progress
°C - °F	Unit of measurement for temperature
rpm	Number of fan rotations
bar -psi	Pressure value

1.10 SETTING PASSWORD, ACCESS AND PARAMETER MODIFICATION

In the manual, whenever necessary
 - enter the password to access the parameters
 - choose, modify and/or confirm parameters
 follow the sequences involved - see table - for more immediate action

Actions	Sequence
password entry	points 1 - 7
parameter choice	points 8-10
modify and confirm parameter	points 11-12a
exit without saving	point 12b
return to the main screen	point 13

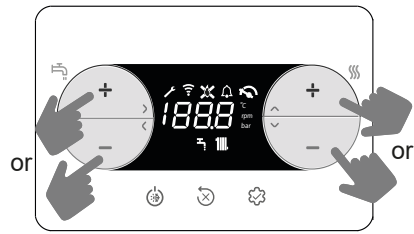

Key pressure =
 - light: value progress of one unit at a time;
 - prolonged: fast forward.

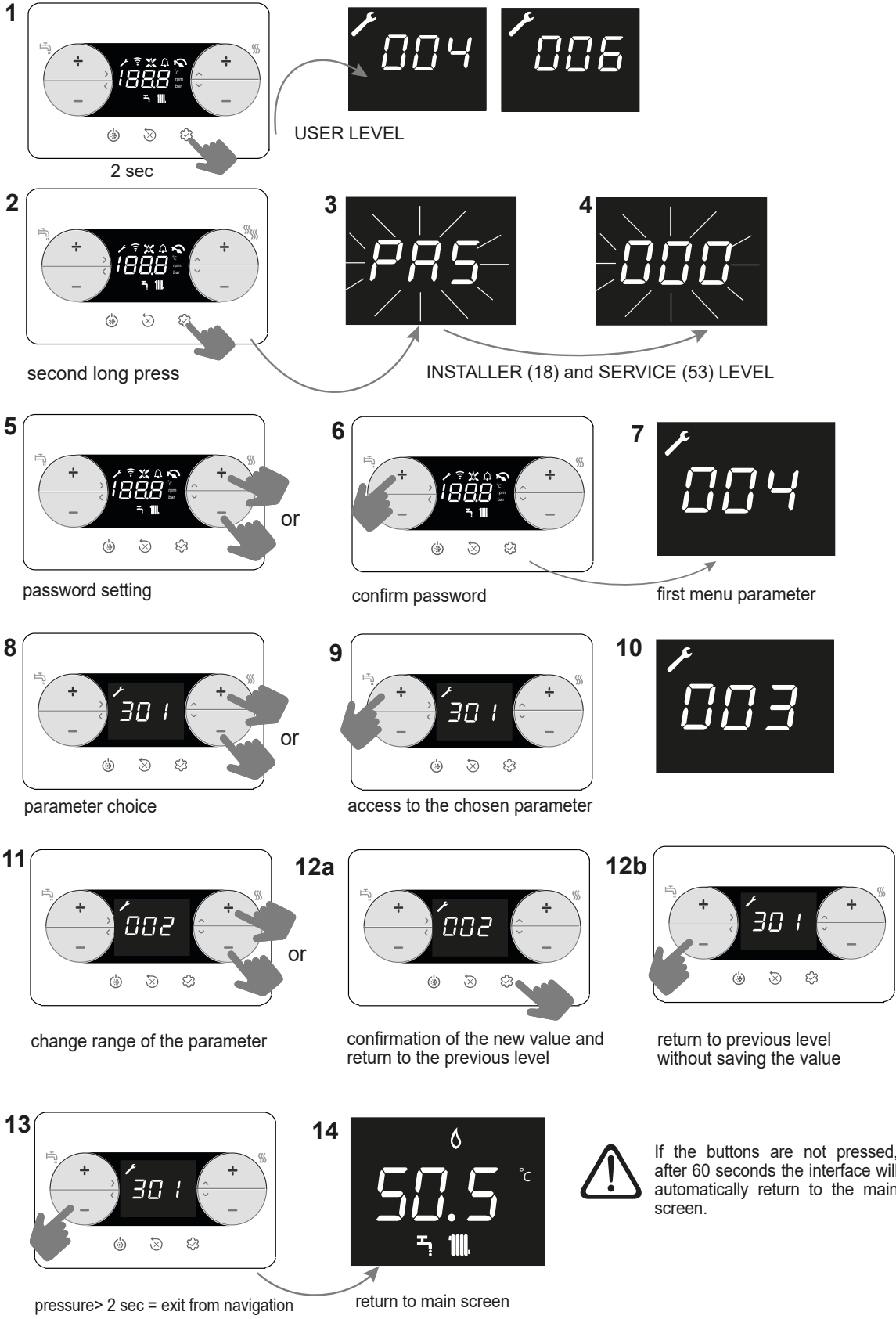

If the buttons are not pressed, after 60 seconds the interface will automatically return to the main screen.

1.11 USER PROGRAMMABLE PARAMETERS

USER PARAMETERS	Value		Password level	Value set in the factory	Personalised values
	min	max			
004	0	1	USER	0	

1.12 INFO MENU

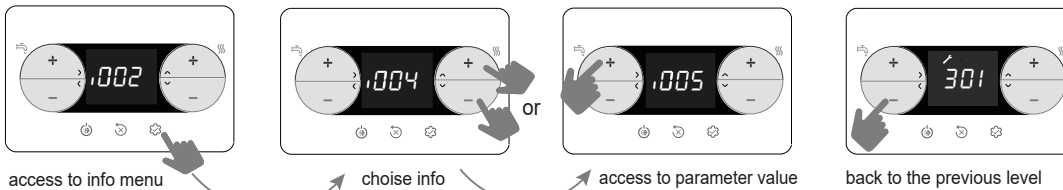

The interface automatically quits the INFO menu if no key is pressed for 60 sec

PARAMETER NAME		DESCRIPTION
I001	Screed heater hours	Number of hours of screed heater function activation
I002	Delivery probe	Boiler delivery probe value
I003	Return probe	Boiler return probe value
I004	Domestic hot water probe	DHW probe value with boiler in instantaneous mode
I005	OT+ DHW setpoint	DHW setpoint sent by OT+ remote control to the boiler
I008	Flue gas probe	Flue gas probe value
I009	External probe	Instantaneous external probe value
I010	External temperature for thermoregulation	Filtered external probe value used in the temperature control algorithm to calculate the heating setpoint
I011	DHW flow rate	DHW setpoint (only with OT+ connection)
I012	Fan rotations	Number of fan rotations (rpm)
I015	Flue gas probe counter	Number of operating hours of the heat exchanger in "condensing mode" (values in thousands are displayed/100)
I016	Delivery setpoint (main zone)	Delivery setpoint for the main zone
I017	OT+ CH setpoint	CH setpoint sent by OT+ remote control to the boiler
I018	System pressure	The system pressure level
I028	Ionization current	Instantaneous ionization current detected by the detection electrode
I029	High efficiency mode	Indicates when the high efficiency mode is running
I032	DHW Comfort	DHW Comfort mode
I033	DHW special functions	Special functions active for high DHW inlet temperatures
I034	ID board	Identification of the electronic board
I035	FW board revision	Firmware revision on the electronic board
I038	WiFi pendrive radio signal	Not available
I039	Alarm history 1 (the oldest)	List of the last five alarms recorded
I040	Alarm history 2	
I041	Alarm history 3	
I042	Alarm history 4	
I043	Alarm history 5 (the latest)	
I044	Reporting number of days for CFS	Number of days that have passed since the CFS signal appeared (707 = 0)

2. GETTING STARTED

2.1 BEFORE SWITCHING ON

Before switching the appliance on, please familiarise yourself with:

- how to isolate the appliance from the gas, water, and electricity supplies;
- how to check and top-up – if necessary – the system water pressure;
- any external thermostats and their functions;
- the appliance controls.

2.2 LIGHTING THE BOILER

- Position the system's main switch to the "on" position.
- Open the gas tap to allow the fuel to flow.
- When the power is enabled, all the icons and segments will light up for 1 sec and the firmware revision will be visualised for 3 sec:



- The automatic venting cycle will then be launched (if it is enabled) and will last 4 min (for the details, refer to the paragraph "5.11 Venting cycle").
- The interface will show the status active in that moment.

Adjust the room thermostat to the required temperature (~ 20°C) or, if the system is equipped with a timed thermostat or programmer, make sure it is "active" and adjusted (~20°C).

- Bring the boiler to WINTER or SUMMER mode.

2.3 OPERATING STATUS

- Pressing key 1, the operating type switches cyclically between OFF - SUMMER - WINTER and then OFF again. In standby, the display shows the system pressure. It shows the delivery temperature if there is a heating request, or the DHW temperature if there is a DHW request.

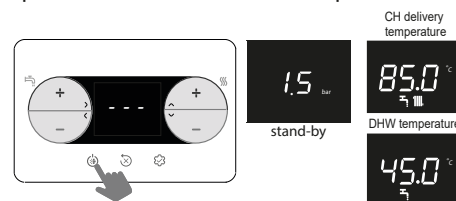

WINTER MODE

The boiler activates the heating and DHW function. The presence of the "🔥" icon indicates a heat request and burner switch-on.

SUMMER MODE

The boiler activates the traditional DHW function.

WINTER

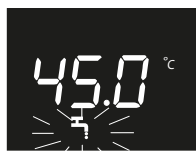

SUMMER

2.4 SETTING THE HEATING SETPOINT



first press



second press
set CH setpoint value
in steps of 0.5 °C

If no key is pressed for 5 sec, the set value is taken as the new heating setpoint.

2.5 SETTING THE HEATING SETPOINT WITH AN EXTERNAL PROBE

If an external probe is connected (optional) and temperature control is enabled (parameter 418=1), the delivery temperature value is selected automatically by the system, which quickly alters the ambient temperature on the basis of variations in the outdoor temperature.

Modifying the heating setpoint

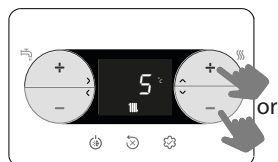

The setpoint correction is in the range (-5 to +5°C).
With parameter 418= 0, the boiler works with a fixed point.

2.6 SETTING THE DHW SETPOINT

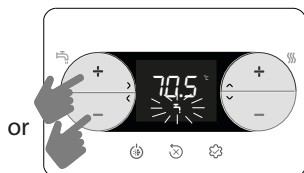

first press



second press
set DHW setpoint value
in steps of 0.5 °C

If no key is pressed for 5 sec, the displayed value is taken as the new DHW setpoint.

2.7 SAFETY STOP

If faults arise during ignition or operation, the boiler makes a "SAFETY STOP". The display shows the error code in question. For the details, refer to "2.13 Faults and reporting".

Reset function

Contact the local Technical Assistance Centre if the reset attempts fail to reactivate normal operation.

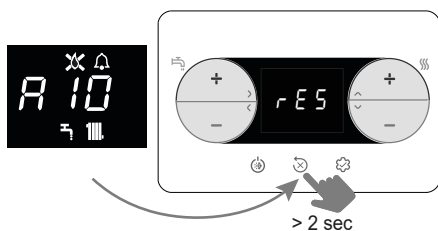

2.8 TEMPORARY SWITCH-OFF

In the event of temporary absences (weekends, short breaks, etc.) set the status of the boiler to OFF.

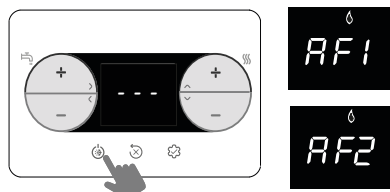

While the electrical supply and the fuel supply remain active, the boiler is protected by the systems:

- **heating anti-freeze:** this function is activated if the temperature measured by the flow sensor drops below 5°C. A heat request is generated in this phase, with burner ignition at the minimum output (then maintained until the delivery water temperature reaches 35°C); the display shows AF1
- **DHW anti-freeze:** this function is activated if the temperature measured by the domestic hot water probe drops below 5°C. A heat request is generated in this phase, with burner ignition at the minimum output (then maintained until the delivery water temperature reaches 55°C); the display shows AF2
- **circulator anti-locking:** The circulator activates every 24 hours of stop for 30 seconds.

2.9 SWITCHING OFF FOR LENGTHY PERIODS

If the boiler is not used for a long time, the following operations must be carried out:

- set the OFF status
- isolate the appliance from the electrical supply
- turn off the fuel and water taps of the heating and domestic hot water system.

In this case, the anti-freeze and anti-blocking systems are deactivated. Drain the heating and domestic water system if there is any risk of freezing.

2.10 KEYBOARD LOCK FUNCTION

To lock the keys:

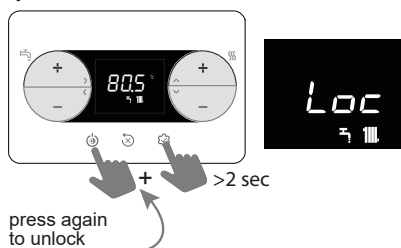

If there is a fault, key 2 remains active to allow the alarm to be reset.

2.11 ALARM HISTORY

The alarm history is active with parameter 701=1 (SERVICE).

Alarms can be viewed:

- info menu (from I039 to I043), in chronological order, from the oldest to the most recent, up to a maximum of 5
- on OT+ remote control, if connected.

When an alarm occurs several times in succession, it is stored only once. To reset the alarm, follow the instructions provided in paragraph "2.7 Safety stop".

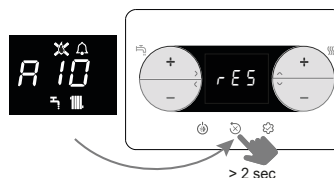

2.12 FEEDER BOTTLE FUNCTION

The Feeder Bottle function is used to block the value of the DHW setpoint, to prevent anyone from accidentally modifying it. To activate the function from the setpoint DHW screen:

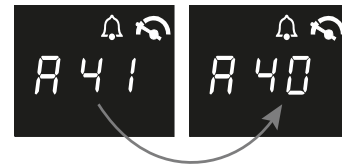
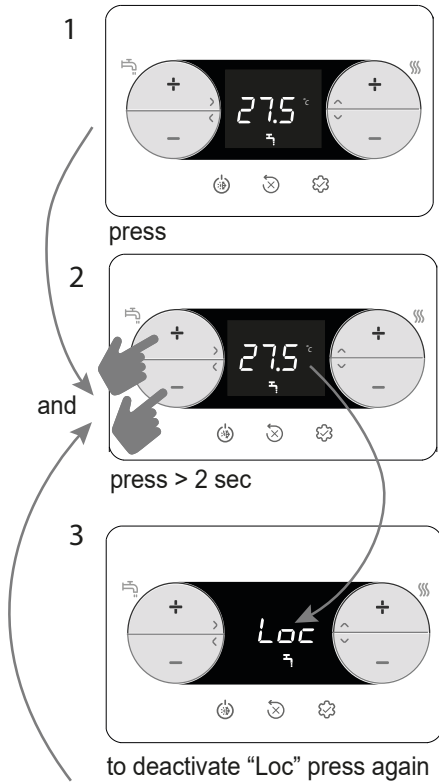

With fault A40 on the boiler it is necessary to top-up the system pressure in the following way:

- open the filling valve slowly until you hear water entering the system
- close the filling valve, access the Info menu ("1.12 INFO menu", item I018) to check that the pressure value reaches 1-1.5 bar:

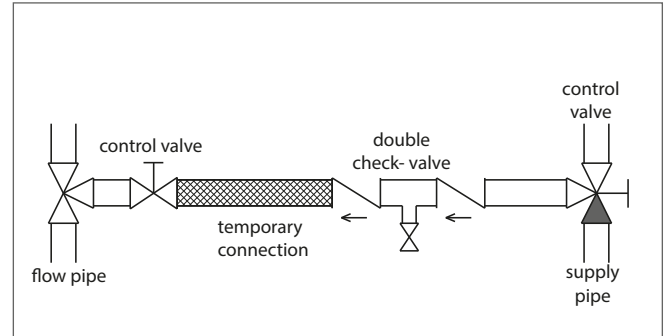

Press to restore operation. After filling, run a venting cycle. If the pressure drop is very frequent, contact the Technical Assistance Centre.

Fault A60

Indicates a fault on the DHW probe; notwithstanding this, the appliance will continue to provide hot water at approximately 50°C. The intervention of the Technical Assistance Centre is required.

Fault A91

The boiler has a self-diagnosis system that signals the need to clean the primary heat exchanger on the basis of the total number of hours in certain operating conditions (alarm code A91). Fault A91 occurs when the counter exceeds the value of 2500 hours; this value can be checked in the "1.12 INFO menu", item I015 (visualization/100, example 2500h = 25).

2.13 FAULTS AND REPORTING

If there is a fault, an error code "Axx" is shown on the display. In certain cases, the error code is accompanied by an icon:

FAULTS	ICONS DISPLAYED
flame failure A10	
all faults except flame failure and water pressure	
water pressure	

Reset function

To reset boiler operation in the event of a fault, press:

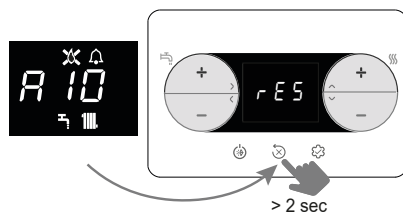

If the correct operating conditions have been restored, the boiler will start up again automatically. In the presence of a remote control, a maximum of 5 consecutive unlocking attempts are available. In this case, by pressing the boiler restores the initial attempts.

If the attempts to reset the boiler do not work, contact the Technical Assistance Centre.

FAULT A41

If the pressure value falls below the 0.3 bar safety value, the boiler shows the fault code A41 for a transitory time of 10 min. If the fault still persists after this time, fault code A40 will appear.

ERROR CODE	ERROR MESSAGE	DESCRIPTION OF TYPE OF ALARM
A10	Flame lockout Condensate drain obstructed Flue gas exhaust/air suction obstructed	definitive
A11	Extraneous flame	transitional
A20	Limit thermostat	definitive
A30	Fan fault	definitive
A40	Fill the system	definitive
A41	Fill the system	transitional
A42	Pressure transducer fault	definitive
A60	DHW probe fault	transitional
A70	Flow sensor fault Flow sensor overtemperature Flow/return sensor differential	transitional definitive definitive
A80	Return probe fault Return probe overtemperature Return-flow sensor differential	transitional definitive definitive
A90	Flue gas probe fault	transitional
A91	Clean primary heat exchanger	transitional
A58	Low power supply voltage	transitional
A59	High power supply voltage	transitional
CFS	Call Service	signal
SFS	Stop for Service	definitive
FIL	Low pressure - check system	signal
>3.0 bar	High pressure - check system	signal

3. WHAT IF...

3.1 WHAT IF I SUSPECT A GAS LEAK

If you suspect a gas leak, turn off the gas supply at the gas meter and contact your installer or local gas supplier. If you require further advice please contact your nearest Vokèra office.

3.2 WHAT IF I HAVE FREQUENTLY TO TOP-UP THE SYSTEM

If the system regularly requires topping-up, it may be indicative of a leak. Please contact your installer and ask him to inspect the system.

3.3 WHAT IF THE APPLIANCE IS DUE ITS ANNUAL SERVICE

Advice for tenants only

Your landlord should arrange for servicing.

Advice for homeowners

Please contact Vokèra Customer Service (**0844 3910999 (UK)** or **056 7755057 (ROI)**) if you would prefer a Vokèra service engineer or agent to service your appliance. Alternatively your local GAS SAFE registered engineer may be able to service the appliance for you.

3.4 WHAT IF I NEED TO CALL AN ENGINEER

If you think your boiler may have developed a fault, please contact your installer or Vokèra Customer Services (**0844 3910999 (UK)** or **056 7755057 (ROI)**) have all your details to hand including full address and postcode, relevant contact numbers, and your completed appliance log book.

INSTALLATION AND SERVICING INSTRUCTIONS

INTRODUCTION

All installers are asked to follow the Benchmark Scheme by adhering to the Code of Practise, details of which can be obtained from www.benchmark.org.uk.

The **VIBE MAX** boiler is an appliances that incorporates electronic ignition, circulating pump, expansion vessel, safety valve, pressure transducer and automatic by-pass.

The **VIBE MAX** range is produced as room sealed, category II2HY203P appliances, suitable for internal wall mounting applications only. Each appliance is provided with a fan powered flue outlet with an annular co-axial combustion air intake that can be rotated – horizontally – through 360 degrees for various horizontal or vertical applications.

The **VIBE MAX** is approved for use with C13 & C33 type flue applications.

These appliances are designed for use with a sealed system only; consequently they are not intended for use on open vented systems.

This booklet is an integral part of the appliance. It is therefore necessary to ensure that the booklet is handed to the person responsible for the property in which the appliance is located/ installed. A replacement copy can be downloaded from the Vokera website (www.vokera.co.uk).

VIBE MAX boiler complies with basic requirements of the following Directives:

- Regulation (EU) 2016/426;
- Yield directive: Article 7(2) and Annex III of directive 92/42/EEC;
- Electromagnetic compatibility directive 2014/30/EU;
- Low-voltage directive 2014/35/EU;
- Directive 2009/125/EC Ecodesign for energy-using appliances;
- Regulation (EU) No. 2017/1369 Energy Labelling;
- Delegated Regulation (EU) No. 811/2013;
- Delegated Regulation (EU) No. 813/2013.



At the end of its life, the product should be not be disposed of as solid urban waste, but rather it should be handed over to a differentiated waste collection and/or recycling centre.

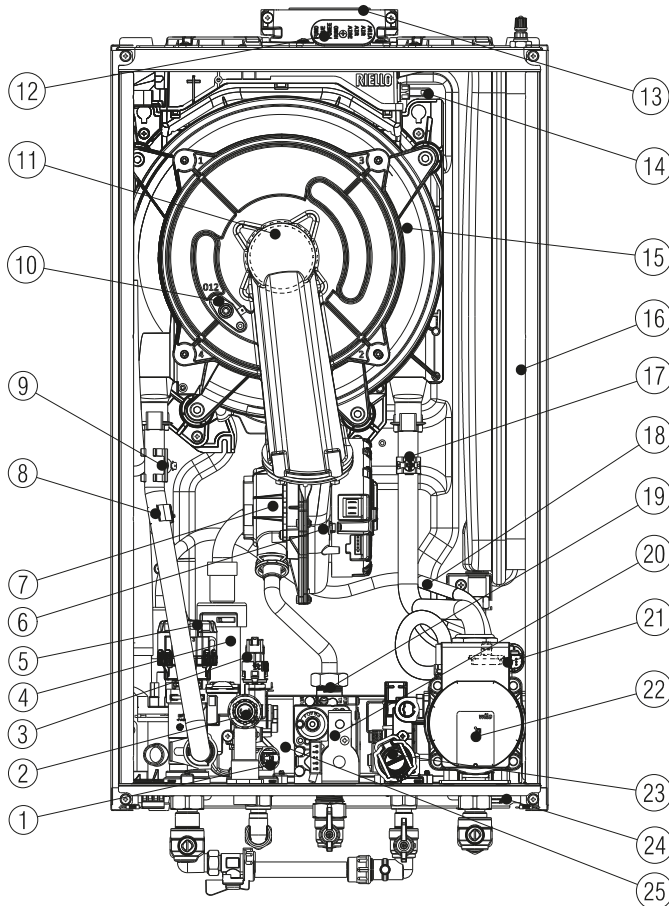

General layout

- 1 Domestic hot water NTC probe
- 2 Safety valve
- 3 Pressure transducer
- 4 Syphon
- 5 3-way valve
- 6 Fan
- 7 Mixer
- 8 Flow thermistor (NTC)
- 9 Limit thermostat
- 10 Electrode
- 11 Burner
- 12 Fume analysis cap
- 13 Top flue outlet
- 14 Flue sensor
- 15 Main heat exchanger
- 16 Expansion vessel
- 17 Return thermistor (NTC)
- 18 Degassing pipe
- 19 Injector
- 20 Gas valve
- 21 Air vent valve
- 22 Pump
- 23 Flowmeter
- 24 Drain valve
- 25 DHW exchanger

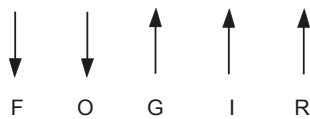

- F Heating flow connection
- O Hot water outlet
- G Gas connection
- I Cold water inlet
- R Heating return connection

Fig. 1

1 DESIGN PRINCIPLES AND OPERATING SEQUENCE

1.1 PRINCIPLE COMPONENTS

- A fully integrated electronic control board featuring electronic temperature control, anti-cycle control, pump over-run, self-diagnostic fault indicator, full air/gas modulation
- Stainless-steel heat exchanger
- Electronic ignition with flame supervision
- Integral high-head pump
- Fan
- Expansion vessel
- Water pressure transducer
- Flue sensor
- Safety valve.

1.2 MODE OF OPERATION (AT REST)

When the appliance is at rest and there are no requests for heating or hot water, the following functions are active:

- frost-protection system: the frost-protection system protects the appliance against the risk of frost damage both for CH and DHW. For CH line, if the main temperature falls to 5°C, the appliance will function on minimum power until the temperature on main reaches 35°C. Moreover if the DHW temperature falls to 5°C, the appliance will function on minimum power until the temperature on main reaches 55°C.
- anti-block function: the anti-block function enables the pump and diverter valve actuator to be energised for short periods, when the appliance has been inactive for more than 24-hours.

1.3 MODE OF OPERATION (HEATING)

When there is a request for heat via the time clock and/or any external control, the pump and fan are started, the fan speed will modulate until the correct signal voltage is received at the control PCB. At this point an ignition sequence is enabled.

Ignition is sensed by the electronic circuit to ensure flame stability at the burner. Once successful ignition has been achieved, the electronic circuitry starts from 60% of the maximum and every 15 minutes it increases by 10%.

Thereafter, the boiler's output will either be increase to maximum or modulate to suit the set requirement. When the appliance reaches the desired temperature the burner will shut down and the boiler will perform a three-minute anti-cycle (timer delay). When the request for heat has been satisfied the appliance pump and fan may continue to operate to dissipate any residual heat within the appliance.

1.4 MODE OF OPERATION (HOT WATER)

When there is a request for DHW via a hot water outlet or tap, the pump and fan are started, the fan speed will modulate until the correct signal voltage is received at the control PCB. At this point an ignition sequence is enabled.

Ignition is sensed by the electronic circuit to ensure flame stability at the burner. Once successful ignition has been achieved, the electronic circuitry increases the gas rate to maximum or will modulate output to stabilise the temperature.

In the event of the appliance exceeding the desired temperature (set point) the burner will shut down until the temperature drops. When the request for DHW has been satisfied the appliance pump and fan may continue to operate to dissipate any residual heat within the appliance.

1.5 SAFETY DEVICES

When the appliance is in use, safe operation is ensured by:

- a water pressure transducer that monitors system water pressure and will de-activate the pump, fan and burner should the system water pressure drop below the rated tolerance;
- fan speed sensor to ensure safe operation of the burner;
- a high limit thermostat that over-rides the temperature control circuit to prevent or interrupt the operation of the burner;
- flame sensor that will shut down the burner when no flame signal is detected;
- flue sensor;
- a safety valve which releases excess pressure from the primary circuit.

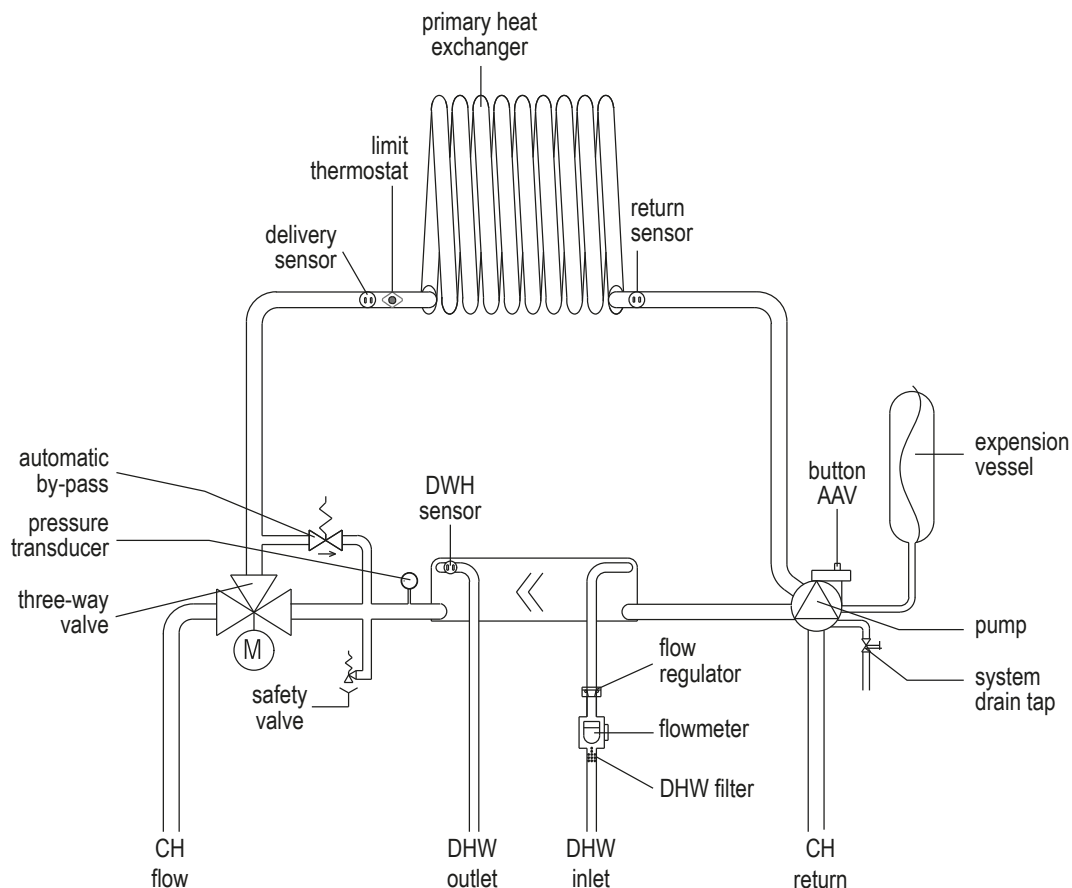

Fig. 2

2 TECHNICAL DATA

Central Heating	VIBE MAX 26C	VIBE MAX 30C
Heat input (kW)	20.00***	25.00***
Maximum heat output (kW) 60/80°C	19.38	24.38
Minimum heat output (kW) 60/80°C	2.94	3.79
Maximum heat output (kW) 30/50°C	20.92	26.78
Minimum heat output (kW) 30/50°C	3.04	4.09
Heat input range rated (Qn) (kW)	20.00	25.00
Minimum heat input range rated (Qm) (kW)	8.20	12.00
Minimum working pressure	0.25÷0.45 bar	
Maximum working pressure	2.5 bar	
Minimum flow rate	350 l/h	
Domestic Hot Water	VIBE MAX 26C	VIBE MAX 30C
Heat input (kW)	25.00***	30.00***
Flow Rate: ΔT35°C	10.20	12.30
Maximum inlet pressure	8 bar	
Minimum inlet pressure	0.5 bar	
Minimum flow rate	2 l/min	
(***) The rated heat input with gas G20.2 (I2Y20) undergoes a reduction: - VIBE MAX 26C: Qn heating = 18kW; Qn DHW = 23kW - VIBE MAX 30C: Qn heating = 23kW; Qn DHW = 27,5kW.		
Gas Pressures	VIBE MAX 26C	VIBE MAX 30C
Nominal methane gas pressure (G20 - I2H)	20.0 mbar	20.0 mbar
Nominal methane-hydrogen gas pressure (G20.2 - I2Y20)	20.0 mbar	20.0 mbar
Heating maximum gas rate (m³/hr)	2.12	2.64
DHW maximum gas rate (m³/hr)	2.64	3.17
Minimum gas rate (m³/hr)	0.33	0.42
Injector size (mm)	4.5	5.1
Fan speed (G20)	VIBE MAX 26C	VIBE MAX 30C
Slow ignition (rpm)	5.500	5.500
CH maximum number of fan rotation (rpm)	7.000	6.900
DHW maximum number of fan rotation (rpm)	8.700	8.300
Minimum number of fan rotation (rpm)	1.500	1.500
Expansion Vessel	VIBE MAX 26C	VIBE MAX 30C
Capacity	8 litres	
Maximum system volume	74 litres	
Pre-charge pressure	1 bar	
Dimensions	VIBE MAX 26C	VIBE MAX 30C
Height (mm)	700	
Width (mm)	400	
Depth (mm)	275	
Dry weight (kg)	28.5	30
Clearances	VIBE MAX 26C	VIBE MAX 30C
Sides	2mm*	
Top	165mm** from casing or 25mm above flue elbow (whichever is applicable)**	
Bottom	150mm^	
Front	4mm^^	
	* Disconnection of adjacent components may be required. Alternatively allow 25mm clearance for removal of side panels. ** Consideration should be given to providing reasonable clearance for the insertion of a FGA probe. ^ This can be reduced to 5mm if a removal panel enables 150mm for maintenance ^^ Provided that a door or removal panel enables 450mm access for maintenance.	
Connections	VIBE MAX 26C	VIBE MAX 30C
Flow & return	22mm	
Gas	15mm	
DHW hot & cold	15mm	
Safety valve	15mm	
Condense	21mm	
Electrical	VIBE MAX 26C	VIBE MAX 30C
Power consumption (Watts) DHW	98	105
Power consumption (Watts) CH	65	88
Voltage (V/Hz)	230/50	
Internal fuse	4A T (for PCB) - 3.15A F (for connections block)	
External fuse	4A	

Flue Details (concentric 60-100)	VIBE MAX 26C	VIBE MAX 30C
Maximum horizontal flue length (60/100mm)	5.85m	4.85m
Maximum vertical flue length (60/100mm)	6.85m	5.85m
Efficiency	VIBE MAX 26C	VIBE MAX 30C
SEDBUK 2005 (%)	89.8	90.0
Emissions	VIBE MAX 26C	VIBE MAX 30C
CO ₂ @ maximum output (%)	9.0	9.0
CO ₂ @ minimum output (%)	9.0	9.0
CO @ maximum output (ppm)	140	150
CO @ minimum output (ppm)	10	10
NO _x rating	class 6	class 6

Parameter	Symbol	VIBE MAX 26C	VIBE MAX 30C	Unit
Seasonal space heating energy efficiency class	-	A	A	-
Water heating energy efficiency class	-	A	A	-
Rated heat output	P _{nominal}	19	24	kW
Seasonal space heating energy efficiency	η_s	93	93	%
Useful heat output				
At rated heat output and high-temperature regime (*)	P ₄	19,4	24,4	kW
At 30% of rated heat output and low-temperature regime (**)	P ₁	6,5	8,2	kW
Useful efficiency				
At rated heat output and high-temperature regime (*)	η_4	87,3	87,6	%
At 30% of rated heat output and low-temperature regime (**)	η_1	98,5	98,2	%
Auxiliary electricity consumption				
At full load	e _{lmax}	32,0	38,0	W
At part load	e _{lmin}	12,0	12,0	W
In Stand-by mode	PSB	3,0	3,0	W
Other parameters				
Stand-by heat loss	P _{stby}	30,0	32,0	W
Pilot flame energy consumption	P _{ign}	-	-	W
Annual energy consumption	Q _{HE}	42	56	GJ
Sound power level, indoors	L _{WA}	50	53	dB
Emissions of nitrogen oxides	NO _x	22	22	mg/kWh
For combination heaters				
Declared load profile		XL	XL	
Water heating energy efficiency	η_{wh}	84	84	%
Daily electricity consumption	Q _{elec}	0,133	0,152	kWh
Daily fuel consumption	Q _{fuel}	23,183	23,306	kWh
Annual electricity consumption	A _{EC}	29	33	kWh
Annual fuel consumption	A _{FC}	18	18	GJ

(*) High-temperature regime means 60 °C return temperature at heater inlet and 80 °C feed temperature at heater outlet.

(**) Low temperature means for condensing boilers 30 °C, for low-temperature boilers 37 °C and for other heaters 50 °C return temperature (at heater inlet).

NOTE (if the outdoor temperature sensor or the control panel, or even both devices, are present in the boiler)

With reference to the Delegated Regulation (EU) No. 811/2013, the information in the table can be used for completing the product data sheet and the labelling for room heating appliances, for mixed heating appliances, for all those appliances for enclosed space heating, for temperature control devices and solar devices:

ADDED DEVICES	CLASS	BONUS
OUTDOOR TEMPERATURE SENSOR	II	2%
CONTROL PANEL*	V	3%
OUTDOOR TEMPERATURE SENSOR + CONTROL PANEL*	VI	4%

(*) Set as ambient regulator

2.1 PUMP DUTY

Fig. 4 shows the flow-rate available – after allowing for pressure loss through the appliance – for system requirements. When using this graph, apply only the pressure loss of the system.

Variable speed circulator

The modulating circulator function is active only in the heating function. When switching the three-way to the domestic hot water, the circulator always works at maximum speed. The modulating circulator function is only applied to the boiler circulator and not to circulators of any connected external devices (e.g. booster circulator).

In this mode the boiler card determines which flow rate value to adopt according to the instantaneous power delivered by the boiler. By entering parameter 405 it is possible to change the extent of the modulation:

- 100 = no modulation
- 60 = modulation max
- 85 = default value

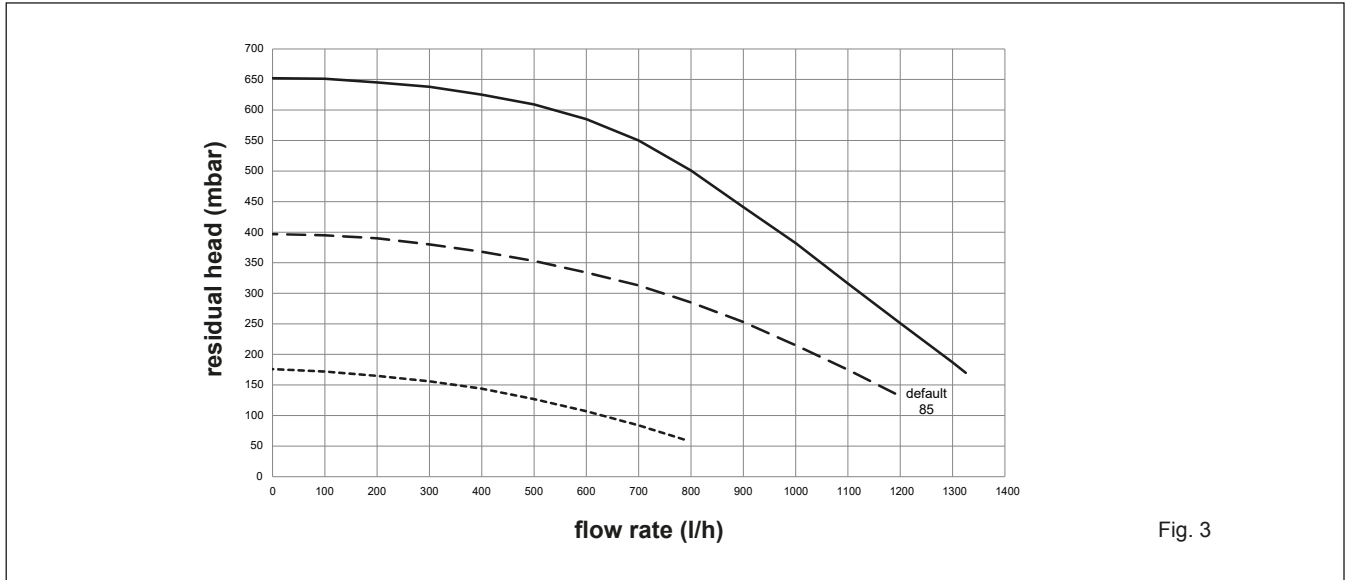

Fig. 3

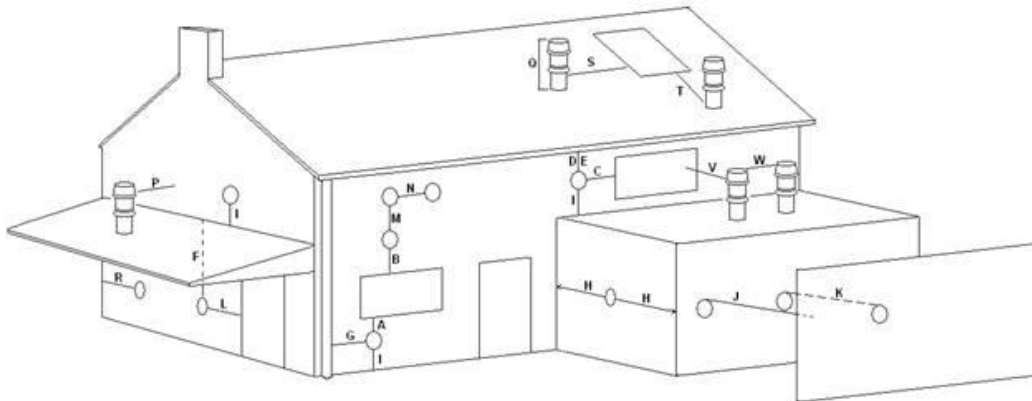

Fig. 4

Key	Location	Minimum distance
A	Below an opening (window, air-brick, etc.)	300 mm
B	Above an opening (window, air-brick, etc.)	300 mm
C	To the side of an opening (window, air-brick, etc.)	300 mm
D	Below gutter, drain-pipe, etc.	25 mm
E	Below eaves	25 mm
F	Below balcony, lowest point of carport roof, etc.	25 mm
G	To the side of a soil/drain-pipe, etc.	25 mm (60mm for 80/125mm)
H	From internal/external corner	25 mm (60mm for 80/125mm)
I	Above ground, roof, or balcony level	300 mm
J	From a surface or boundary facing the terminal	600 mm*
K	From a terminal facing a terminal	1200 mm
L	From an opening in the car-port into the building	1200 mm
M	Vertically from a terminal on the same wall	1500 mm
N	Horizontally from a terminal on the same wall	300 mm
P	From a structure to the side of the vertical terminal	300 mm
Q	From the top of the vertical terminal to the roof flashing	As determined by the fixed collar of the vertical terminal
R	To the side of a boundary	300 mm
S	To the side of an opening or window on a pitched roof	600 mm
T	Below an opening or window on a pitched roof	2000 mm
V	From a vertical terminal to an adjacent opening (window, air-brick, etc.)	2000 mm
W	From a vertical terminal to an adjacent vertical terminal	300 mm (only if both terminals are the same height)

*The possibility that this may be deemed as causing a nuisance, should be considered

3 GENERAL REQUIREMENTS (UK)

BS 5440	PART 1	FLUES
BS 5440	PART 2	FLUES & VENTILATION
BS EN 12828		DESIGN FOR WATER-BASED HEATING SYSTEMS
BS 5546		INSTALLATION OF GAS HOT WATER SUPPLIES FOR DOMESTIC PURPOSES
BS 6798		INSTALLATION OF BOILERS OF RATED INPUT NOT EXCEEDING 60kW
BS 6891		LOW PRESSURE INSTALLATION PIPES
BS 7074	PART 1	APPLICATION, SELECTION, AND INSTALLATION OF EXPANSION VESSELS AND ANCILLARY EQUIPMENT FOR SEALED WATER SYSTEMS

This appliance must be installed by a competent person in accordance with the Gas Safety (Installation & Use) Regulations.

3.1 RELATED DOCUMENTS

The installation of this boiler must be in accordance with the relevant requirements of the Gas Safety (Installation & Use) Regulations, the local building regulations, the current I.E.E. wiring regulations, the bylaws of the local water authority, the Building Standards (Scotland) Regulation and Building Standards (Northern Ireland) Regulations.

It should be in accordance also with any relevant requirements of the local authority and the relevant recommendations of the following British Standard Codes of Practice.

ATTENTION

The use of PPE (Personal Protective Equipment) such as but not limited to gloves, mask, safety glasses, etc. is strongly recommended whenever carrying out the installation, repair, or maintenance of this appliance – please pay particular attention to:

- Sharp edges that may be encountered when:- handling or lifting the appliance, removing parts, etc. during installation and maintenance
- Airborne particles that may be released and/or disturbed when cleaning or removing components during maintenance
- Water treatment chemicals that could have been added to the system water may spill from the appliance and or components during maintenance

Please refer to an appropriate Health and Safety document such as HSE L23 (UK) or S.I. 299 (Ireland), for more detailed advice on safe working practices and procedures.

3.2 LOCATION OF APPLIANCE

The appliance may be installed in any room or internal space, although particular attention is drawn to the requirements of the current I.E.E. wiring regulations, and in Scotland, the electrical provisions of the Building Regulations, with respect to the installation of the appliance in a room or internal space containing a bath or shower.

When an appliance is installed in a room or internal space containing a bath or shower, the appliance or any control pertaining to it must not be within reach of a person using the bath or shower. The location chosen for the appliance must permit the provision of a safe and satisfactory flue and termination. The location must also permit an adequate air supply for combustion purposes and an adequate space for servicing and air circulation around the appliance. Where the installation of the appliance will be in an unusual location special procedures may be necessary, BS 6798 gives detailed guidance on this aspect. A compartment used to enclose the appliance must be designed and constructed specifically for this purpose. An existing compartment/cupboard may be utilised provided that it is modified to suit. Details of essential features of compartment/cupboard design including airing cupboard installations are given in BS 6798. This appliance is not suitable for external installation.

3.3 GAS SUPPLY

The gas meter – as supplied by the gas supplier – must be checked to ensure that it is of adequate size to deal with the maximum rated input of all the appliances that it serves. Installation pipes must be fitted in accordance with BS 6891.

Pipe work from the meter to the appliance must be of adequate size. Pipes of a smaller size than the appliance gas inlet connection must not be used. The installation must be tested for tightness in accordance with BS6891.

If the gas supply serves more than one appliance, it must be ensured that an adequate supply is maintained to each appliance when they are in use at the same time.

NOTE

It is recognised that 'pressure loss' through the gas cock and gas valve may result in a pressure drop of approximately 2mbar between the gas meter and gas valve inlet test point; this will not impair the performance of the appliance, provided that a dynamic pressure of 18mbar is available at the appliance inlet.

3.4 FLUE SYSTEM

The terminal should be located where the dispersal of combustion products is not impeded and with due regard for the damage and discoloration that may occur to building products located nearby. The terminal must not be located in a place where it is likely to cause a nuisance (see "Fig. 4"). In cold and/or humid weather, water vapour will condense on leaving the terminal; the effect of such plumbing must be considered.

If installed less than 2m above a pavement or platform to which people have access (including balconies or flat roofs) the terminal must be protected by a guard of durable material. The guard must be fitted centrally over the terminal. Refer to BS 5440 Part 1, when the terminal is 0.5 metres (or less) below plastic guttering or 1 metre (or less) below painted eaves.

3.5 AIR SUPPLY

The following notes are intended for general guidance only. This appliance is a room-sealed, fan-flued boiler, consequently it does not require a permanent air vent for combustion air supply. When installed in a cupboard or compartment, ventilation for cooling purposes is also not required.

3.6 WATER CIRCULATION

Detailed recommendations are given in BS EN 12828 and BS 6798. The following notes are for general guidance only.

3.6.1 PIPEWORK

It is recommended that copper tubing to BS 2871 Part 1 is used in conjunction with soldered capillary joints. Where possible pipes should have a gradient to ensure air is carried naturally to air release points and that water flows naturally to drain cocks. Except where providing useful heat, pipes should be insulated to avoid heat loss and in particular to avoid the possibility of freezing. Particular attention should be paid to pipes passing through ventilated areas such as under floors, loft space and void areas.

3.6.2 AUTOMATIC BY-PASS

The appliance has a built-in automatic by-pass, consequently there is no requirement for an external by-pass, however the design of the system should be such that it prevents boiler 'cycling'.

3.6.3 DRAIN COCKS

These must be located in accessible positions to facilitate draining of the appliance and all water pipes connected to the appliance. The drain cocks must be manufactured in accordance with BS 2879.

3.6.4 AIR RELEASE POINTS

These must be positioned at the highest points in the system where air is likely to be trapped. They should be used to expel trapped air and allow complete filling of the system.

3.6.5 EXPANSION VESSEL

The appliance has an integral expansion vessel to accommodate the increased volume of water when the system is heated. It can accept up to 8 litres of expansion from within the system, generally this is sufficient, however if the system has an unusually high water content, it may be necessary to provide additional expansion capacity.

3.6.6 FILLING POINT

A method for initial filling of the system and replacing water lost during servicing etc. directly from the mains supply, is provided (see Fig. 14). This method of filling should comply with the current Water Supply (Water Fittings) Regulations 1999 and Water Bylaws 2000 (Scotland). If an alternative location is preferred, it should be connected as detailed in Fig. 5.

3.6.7 LOW PRESSURE SEALED SYSTEM

An alternative method of filling the system would be from an independent make-up vessel or tank mounted in a position at least 1 metre above the highest point in the system and at least 5 metres above the boiler (see "Fig. 6").

The cold feed from the make-up vessel or tank must be fitted with an approved non-return valve and stopcock for isolation purposes. The feed pipe should be connected to the return pipe as close to the boiler as possible.

3.6.8 FREQUENT FILLING

Frequent filling or venting of the system may be indicative of a leak. Care should be taken during the installation of the appliance to ensure all aspects of the system are capable of withstanding pressures up to at least 3 bar.

3.7 ELECTRICAL SUPPLY

The appliance is supplied for operation on 230V @ 50Hz electrical supply; it must be protected with a 3-amp fuse. The method of connection to the mains electricity supply must allow for complete isolation from the supply. The preferred method is by using a double-pole switch fused spur with a contact separation of at least 3,5mm (3° high-voltage category). The switch must only supply the appliance and its corresponding controls, i.e. time clock, room thermostat, etc. Alternatively an un-switched shuttered socket with a fused 3-pin plug both complying with BS 1363 is acceptable.

NOTE

Vokera Ltd. cannot guarantee the performance or reliability of the appliance if/when it is supplied via an inverter or generator; in particular those that incorporate a 'floating' earth or 'modified' sine wave.

Warning!

This appliance must be earthed.

3.8 MOUNTING ON A COMBUSTIBLE SURFACE

The appliance can be mounted on a wall of combustible material without any requirement to fit any additional protective (fire-resistant) material.

3.9 TIMBER FRAMED BUILDINGS

If the appliance is to be fitted in a timber framed building, it should be fitted in accordance with the Institute of Gas Engineers publication (IGE/UP/7) 'Guide for Gas Installations in Timber Frame Buildings'.

3.10 WATER TREATMENT

Vokera recommend that an inhibitor - suitable for use with stainless-steel heat exchangers - is used to protect the boiler and system from the effects of corrosion and/or electrolytic action. The inhibitor must be administered in strict accordance with the manufacturers instructions*.

*Water treatment of the complete heating system - including the boiler - should be carried out in accordance with BS 7593 and the Domestic Water Treatment Association's (DwTA) code of practice. Vokera recommend that water treatment be carried out in accordance with the Benchmark Guidance on water treatment in central heating systems. If water treatment products are to be used, then they must be entirely suitable for use with an Stainless-steel heat exchanger. Any water treatment product, must be administered in strict accordance with the manufacturer's instructions.

If the appliance is to be installed to an existing system; water treatment and flushing of the complete heating system should be carried out in accordance with BS 7593 and the Benchmark Guidance on water treatment in central heating systems.

3.11 SHOWERS

If the appliance is intended for use with a shower, the shower must be thermostatically controlled and be suitable for use with a combination boiler.

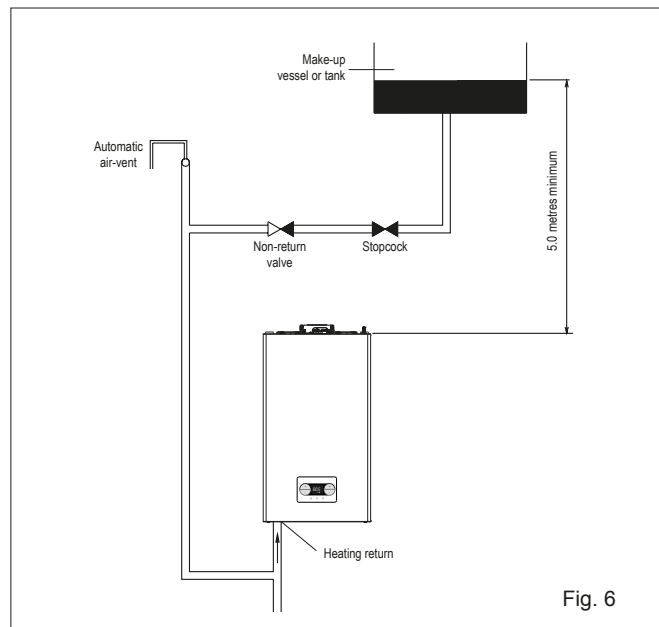
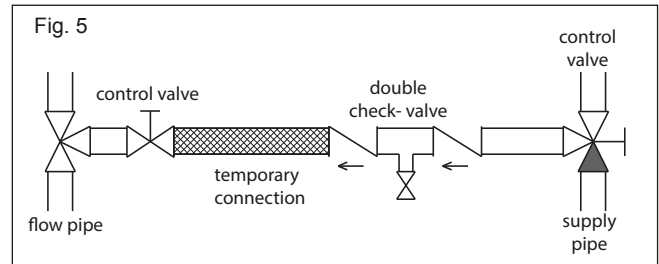

3E GENERAL REQUIREMENTS (EIRE)

This appliance must be installed by a competent person in accordance with and defined by, the Standard Specification (Domestic Gas Installations) Declaration (I.S. 813).

3.1E RELATED DOCUMENTS

The installation of this boiler must be in accordance with the relevant requirements of the local building regulations, the current ETCI National Rules for Electrical Installations and the bylaws of the local water undertaking.

It should be in accordance also with any relevant requirements of the local and/or district authority.

ATTENTION

The use of PPE (Personal Protective Equipment) such as but not limited to gloves, mask, safety glasses, etc. is strongly recommended whenever carrying out the installation, repair, or maintenance of this appliance – please pay particular attention to:

- Sharp edges that may be encountered when:- handling or lifting the appliance, removing parts, etc. during installation and maintenance

- Airborne particles that may be released and/or disturbed when cleaning or removing components during maintenance
- Water treatment chemicals that could have been added to the system water may spill from the appliance and or components during maintenance

Please refer to an appropriate Health and Safety document such as HSE L23 (UK) or S.I. 299 (Ireland), for more detailed advice on safe working practices and procedures.

3.2E LOCATION OF APPLIANCE

The appliance may be installed in any room or internal space, although particular attention is drawn to the requirements of the current ETCI National Rules for Electrical Installations, and I.S. 813, Annex K. When an appliance is installed in a room or internal space containing a bath or shower, the appliance or any control pertaining to it must not be within reach of a person using the bath or shower. The location chosen for the appliance must permit the provision of a safe and satisfactory flue and termination. The location must also permit an adequate air supply for combustion purposes and an adequate space for servicing and air circulation around the appliance.

Where the installation of the appliance will be in an unusual location special procedures may be necessary, refer to I.S. 813 for detailed guidance on this aspect.

A compartment used to enclose the appliance must be designed and constructed specifically for this purpose. An existing compartment/cupboard may be utilised provided that it is modified to suit.

This appliance is not suitable for external installation.

3.3E GAS SUPPLY

The gas meter – as supplied by the gas supplier – must be checked to ensure that it is of adequate size to deal with the maximum rated input of all the appliances that it serves. Installation pipes must be fitted in accordance with I.S. 813.

Pipe work from the meter to the appliance must be of adequate size. Pipes of a smaller size than the appliance gas inlet connection must not be used. The installation must be tested for tightness in accordance with I.S. 813.

If the gas supply serves more than one appliance, it must be ensured that an adequate supply is maintained to each appliance when they are in use at the same time.

NOTE

It is recognised that 'pressure loss' through the gas cock and gas valve may result in a pressure drop of approximately 2mbar between the gas meter and gas valve inlet test point; this will not impair the performance of the appliance, provided that a dynamic pressure of 18mbar is available at the appliance inlet.

3.4E FLUE SYSTEM

The terminal should be located where the dispersal of combustion products is not impeded and with due regard for the damage and discoloration that may occur to building products located nearby. The terminal must not be located in a place where it is likely to cause a nuisance (see I.S. 813).

In cold and/or humid weather, water vapour will condense on leaving the terminal; the effect of such plumbing must be considered.

If installed less than 2m above a pavement or platform to which people have access (including balconies or flat roofs) the terminal must be protected by a guard of durable material. The guard must be fitted centrally over the terminal. Refer to I.S. 813, when the terminal is 0.5 metres (or less) below plastic guttering or 1 metre (or less) below painted eaves.

3.5E AIR SUPPLY

The following notes are intended for general guidance only. This appliance is a room-sealed, fan-flued boiler, consequently it does not require a permanent air vent for combustion air supply. When installed in a cupboard or compartment, ventilation for cooling purposes is also not required.

3.6E WATER CIRCULATION

Specific recommendations are given in I.S. 813. The following notes are for general guidance only.

3.6.1E PIPEWORK

It is recommended that copper tubing be used in conjunction with soldered capillary joints.

Where possible pipes should have a gradient to ensure air is carried naturally to air release points and that water flows naturally to drain cocks.

Except where providing useful heat, pipes should be insulated to avoid heat loss and in particular to avoid the possibility of freezing. Particular attention should be paid to pipes passing through ventilated areas such as under floors, loft space and void areas.

3.6.2E AUTOMATIC BY-PASS

The appliance has a built-in automatic by-pass, consequently there is no requirement for an external by-pass, however the design of the system should be such that it prevents boiler 'cycling'.

3.6.3E DRAIN COCKS

These must be located in accessible positions to facilitate draining of the appliance and all water pipes connected to the appliance.

3.6.4E AIR RELEASE POINTS

These must be positioned at the highest points in the system where air is likely to be trapped. They should be used to expel trapped air and allow complete filling of the system.

3.6.5E EXPANSION VESSEL

The appliance has an integral expansion vessel to accommodate the increased volume of water when the system is heated. Refer to the specification table for more detailed information.

3.6.6E FILLING POINT

A method for initial filling of the system and replacing water lost during servicing etc. directly from the mains supply, is provided (see Fig. 14). This method of filling complies with the current Water Supply (Water Fittings) Regulations 1999 and Water Bylaws 2000 (Scotland).

3.6.7E LOW PRESSURE SEALED SYSTEM

An alternative method of filling the system would be from an independent make-up vessel or tank mounted in a position at least 1 metre above the highest point in the system and at least 5 metres above the boiler (see "Fig. 6"). The cold feed from the make-up vessel or tank must be fitted with an approved non-return valve and stopcock for isolation purposes. The feed pipe should be connected to the return pipe as close to the boiler as possible.

3.6.8E FREQUENT FILLING

Frequent filling or venting of the system may be indicative of a leak. Care should be taken during the installation of the appliance to ensure all aspects of the system are capable of withstanding pressures up to at least 3 bar.

3.7E ELECTRICAL SUPPLY

The appliance is supplied for operation on 230V @ 50Hz electrical supply; it must be protected with a 3-amp fuse. The method of connection to the mains electricity supply must allow for complete isolation from the supply. The preferred method is by using a double-pole switch fuse spur with a contact separation of at least 3,5 mm (3° high-voltage category). The switch must only supply the appliance and its corresponding controls, i.e. time clock, room thermostat, etc.

NOTE

Vokera Ltd. cannot guarantee the performance or reliability of the appliance if/when it is supplied via an inverter or generator; in particular those that incorporate a 'floating' earth or 'modified' sine wave.

3.8E MOUNTING ON A COMBUSTIBLE SURFACE

The appliance can be mounted on a wall of combustible material without any requirement to fit any additional protective (fire-resistant) material.

3.9E TIMBER FRAMED BUILDINGS

If the appliance is to be fitted in a timber framed building, it should be fitted in accordance with I.S. 813 and local Building Regulations.

The Institute of Gas Engineers publication (IGE/UP/7) 'Guide for Gas Installations in Timber Frame Buildings' gives specific advice on this type of installation.

3.10E WATER TREATMENT

Vokera recommend that an inhibitor - suitable for use with Stainless-steel heat exchangers - is used to protect the boiler and system from the effects of corrosion and/or electrolytic action. The inhibitor must be administered in strict accordance with the manufacturers instructions*.

*Water treatment of the complete heating system - including the boiler - should be carried out in accordance with BS 7593 and the Domestic Water Treatment Association's (DWTA) code of practice. Vokera recommend that water treatment be carried out in accordance with the Benchmark Guidance on water treatment in central heating systems. If water treatment products are to be used, then they must be entirely suitable for use with an Stainless-steel heat exchanger. Any water treatment product, must be administered in strict accordance with the manufacturer's instructions.

If the appliance is to be installed to an existing system; water treatment and flushing of the complete heating system should be carried out in accordance with BS 7593 and the Benchmark Guidance on water treatment in central heating systems.

3.11E SHOWERS

If the appliance is intended for use with a shower, the shower must be thermostatically controlled and be suitable for use with a combination boiler.

3.12E DECLARATION OF CONFORMITY

A Declaration of Conformity (as defined in I.S. 813) must be provided on completion of the installation.

A copy of the declaration must be given to the responsible person and also to the gas supplier if required.

4 INSTALLATION

NOTE

Please refer to 3 - 3E and use the appropriate PPE when carrying out any of the actions or procedures contained within this section.

4.1 PREPARATION FOR MOUNTING THE APPLIANCE

The appliance should be mounted on a smooth, vertical surface, which must be capable of supporting the full weight of the appliance. Care should be exercised when determining the position of the appliance with respect to hidden obstructions such as pipes, cables, etc.

When the position of the appliance has been decided – using the template supplied – carefully mark the position of the anchor holes (see Fig. 7) and flue-hole (if applicable).

Ensure that the anchors are securely fixed to support the appliance weight.

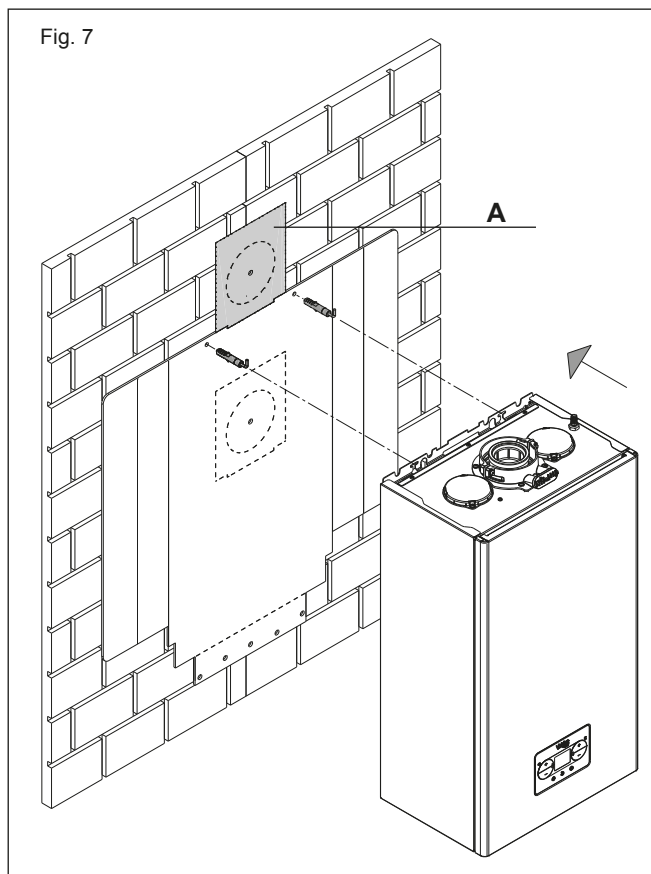

Fig. 7

4.2 FITTING THE FLUE

This appliance incorporates a 'click-fit' flue connection at the top of the appliance.

4.2.1 CONCENTRIC HORIZONTAL FLUE

These instructions relate specifically to the installation of this appliance with the Vokera 60/100mm 'X-type' (click-fit) flue terminals accessories. For specific instructions on installing this appliance with an alternative Vokera flue system, e.g. 80/125mm; please refer to the instructions supplied with the specific flue system, or download the instructions from the Vokera website. The appliance flue outlet elbow can be rotated through 360° on its vertical axis. In addition the flue may be extended from the outlet elbow in the horizontal plane. A reduction must also be made to the maximum length (see table below) when additional bends are used.

Reduction for additional bends

Bend	Reduction in maximum flue length for each bend
45° bend	1.0 metre
90° bend	1.0 metre

Horizontal/Vertical flue terminals and accessories

Part No.	Description	Length/Size
20122759	XF Horizontal 'Click fit' Flue Kit	796mm C/E
20122761	XT Telescopic 'Click fit' Flue Kit	400-575mm C/E
20122763	XV Vertical 'Click fit' Flue Kit	1000mm + VC
20132060	0.5-Metre Extension	500mm
20132061	1.0-Metre Extension	1000mm
20132062	2.0-Metre Extension	2000mm
20132059	90-Degree Bend	N/A
20132058	45-Degree Bend x 2	N/A
20131979	Telescopic Extension	372/519mm
20142842	PMK Plume Kit	1370mm
20142841	45° Plume diverter	N/A
20132050	Pitched Roof Flashing	500mm x 500mm
20135582	Flat Roof Flashing	340mm Dia.
20135587	Wall Brackets	208mm C/E
20121903	Vert. Connector 'Click Fit' VC	131mm

Fig. 7: Using the template (A) mark and drill a 125mm hole for the passage of the flue pipe. Both horizontal terminals (fixed & telescopic) have an eccentric configuration, that enables condense fluid to drain back to the appliance; consequently the terminals should be installed level.

NOTE: any horizontal runs that incorporate extensions, must have a 3-degree fall-back to the appliance.

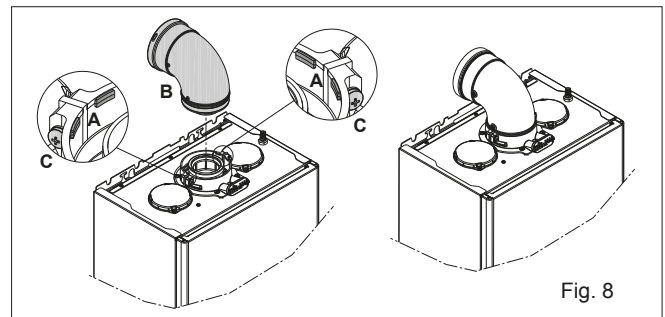

Fig. 8

4.2.2 FITTING THE HORIZONTAL FLUE KIT

Carefully measure the distance from the centre of the appliance flue outlet to the edge of the finished outside wall (dimension X). Add 65mm to dimension X to give you Dimension Y (see Fig. 9). Measure dimension Y from the terminal end of the concentric flue pipe and cut off the excess ensuring any burrs are removed. Pass the concentric flue pipe through the previously drilled hole. Fit the flue bend to the boiler flue outlet and insert the concentric flue pipe into the flue bend ensuring the correct seal is made.

NOTE (Fig. 8): The appliance incorporates a 'click-fit' flue connection. Ensure that both screws 'C' on the 'click-fit' have been slackened off. Ensure that the connector is correctly aligned with the 'click-fit' and insert it into the 'click-fit' until it clicks into position (this is when the tabs at points 'A' are located in the groove of the flue bend connector). Both screws (C) should now be tightened.

NOTE

Fit the internal (white) trim to the flue assembly prior to connecting the flue pipe to the bend. You must ensure that the entire flue system is properly supported and connected. Seal the flue assembly to the wall using cement or a suitable alternative that will provide satisfactory weatherproofing. The exterior trim can now be fitted.

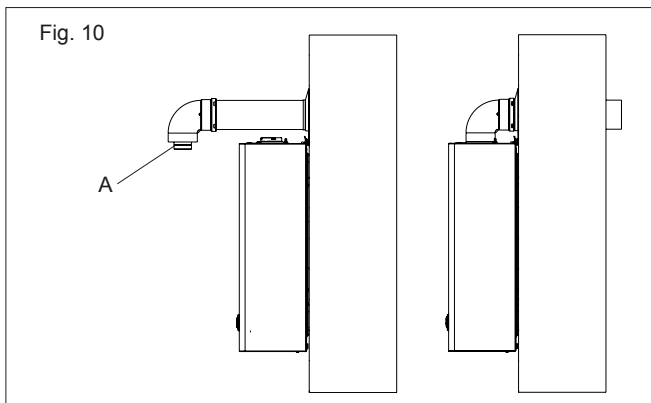
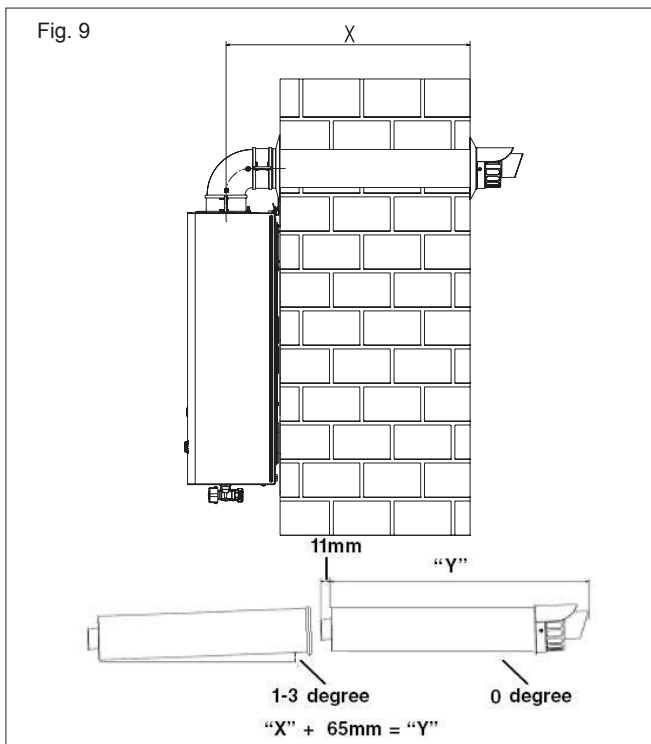

4.2.3 EXTENDING THE FLUE

Connect the bend – supplied with the terminal kit – to the top of the boiler using clamp (supplied). The additional bends & extensions have push-fit connections, care should be taken to ensure that the correct seal is made when assembling the flue system. Connect the required number of flue extensions or bends (up to the maximum equivalent flue length) to the flue terminal (Fig. 11). The flue system should have a 3° rise from the boiler to outside, to ensure any condense fluid that forms, is allowed to drain back to the appliance.

NOTE

When cutting an extension to the required length, you must ensure that the excess is cut from the plain end of the extension (Fig. 11). Remove any burrs, and check that all seals are located properly. You must ensure that the entire flue system is properly supported and connected. Seal the flue assembly to the wall using cement or a suitable alternative that will provide satisfactory weatherproofing. The interior and exterior trim can now be fitted.

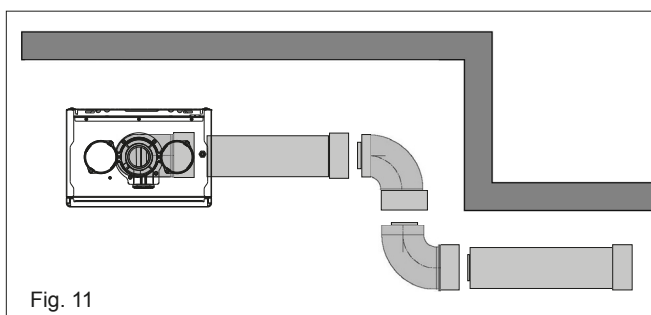

4.2.4 CONCENTRIC VERTICAL FLUE

Using Fig. 13 as a reference, cut a 110mm diameter hole in the roof and/or ceiling to facilitate the route of the vertical flue system. **NOTE:** ensure that the top of the appliance - if already in position - is covered and protected from the possibility of any dust or debris falling or entering the appliance via the flue outlet.

Fit the appropriate flashing to the roof and insert the vertical flue terminal through the flashing from outside, ensuring that the collar of the terminal is located over the outlet of the flashing.

The fixing holes for the appliance wall mounting bracket should now be drilled and plugged. An appropriate type and quantity of fixing should be used to ensure that the bracket is mounted securely. Once the bracket has been secured to the wall, mount the appliance onto the bracket.

If the vertical flue system requires additional extensions or bends, connect these to the vertical terminal, ensuring the following:

- the maximum permitted flue length is not exceeded
- reductions to the maximum flue length have been made for any bends that are used on the vertical flue system
- any horizontal sections of the flue system, incorporate a 3-degree fallback to the appliance
- the entire flue system is fully supported and secured using the appropriate brackets
- if/when an extension is cut to a shorter length, ensure that the excess length is cut from the plain end of the extension, and that any burrs or rough edges are removed
- all seals are properly located before assembling or connecting the flue system.

IMPORTANT: The VX flue terminal is supplied with a sachet of silicone lubricant; smear a small amount of the lubricant around both inner and outer connections, at both ends of the vertical flue connector (supplied with the VX terminal).

NOTE (Fig. 12): The appliance incorporates a 'click-fit' flue connection. Ensure that both screws 'C' on the 'click-fit' have been slackened off. Ensure that the connector is correctly aligned with the 'click-fit' and insert it into the 'click-fit' until it clicks into position (this is when the tabs at points 'A' are located in the groove of the vertical flue connector). Both screws (C) should now be tightened.

NOTE: If more convenient, the vertical flue connector can be attached to the vertical flue terminal/extension before connecting it to the appliance.

NOTE

Additional bends and/or extensions can be connected to the terminal connector if desired, however if additional bends are fitted, a reduction must be made to the maximum flue length (see table below).

Reduction for bends

Bend	Reduction in maximum flue length for each bend
45° bend	1.0 metre
90° bend	1.0 metre

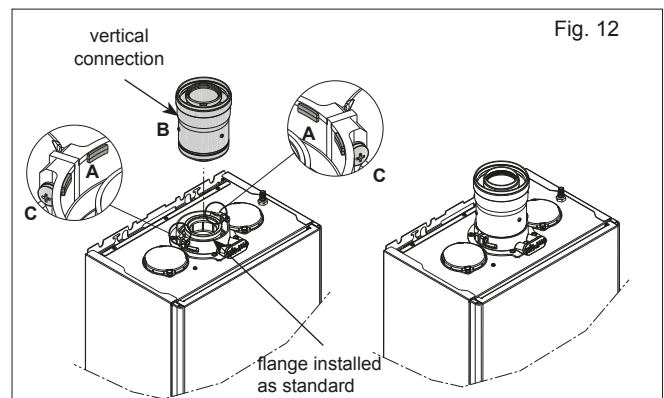

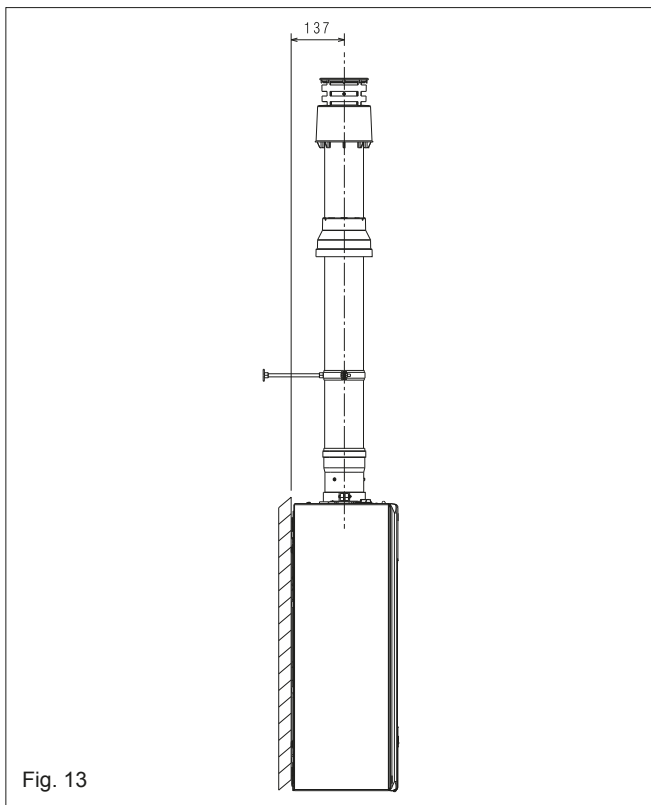

Fig. 13

IMPORTANT

The vertical flue terminal is 1.0 metre in length and cannot be cut; therefore it may be necessary to adjust the height of the appliance to suit or use a suitable extension.

4.3 CONNECTING THE GAS & WATER (FIG. 14)

The appliance is supplied with an accessory pack that includes service valves. The service valves are of the compression type. The accessory pack contains sealing washers' etc, for use with the service valves. When connecting pipe work to the valves, tighten the compression end first then insert the sealing washers before tightening the valve to the appliance.

NOTE: it will be necessary to hold the valve with one spanner whilst tightening with another.

The valves must be fitted perpendicular with the rear of the appliance, in order to avoid obstruction and ensure that the filling loop attaches correctly.

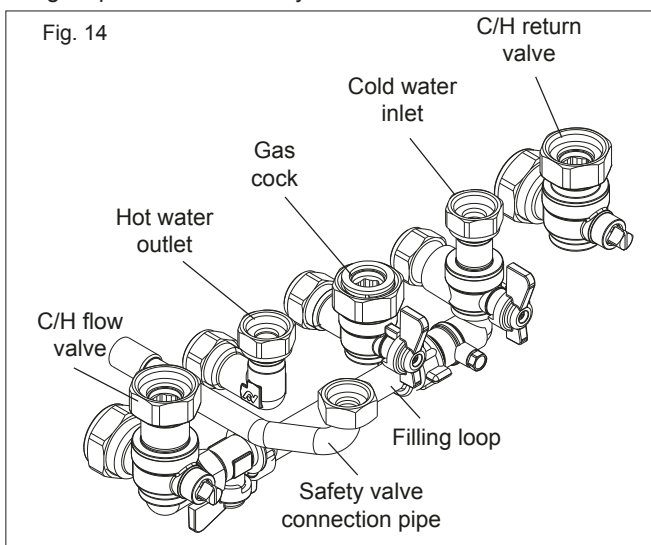

Fig. 14

4.3.1 GAS

The appliance is supplied with a 15mm service valve, connect a 15mm pipe to the inlet of the valve and tighten both nuts.

NOTE: it will be necessary to calculate the diameter of the gas supply pipe to ensure the appliance has an adequate supply of gas.

4.3.2 FLOW & RETURN

The appliance is supplied with 22mm service valves for the flow and return connections, connect a 22mm pipe to the inlet of each valve and tighten both nuts.

NOTE: depending on system requirements, it may necessary to increase the size of the flow & return pipe work after the service valve connections.

4.3.3 COLD WATER INLET

The appliance is supplied with a 15mm combined stopcock and filling valve, connect a 15mm pipe to the inlet of the stopcock and tighten both nuts.

4.3.4 HOT WATER OUTLET

The appliance is supplied with a 15mm outlet connection, connect a 15mm pipe to the outlet connection and tighten both nuts.

4.3.5 SAFETY VALVE

Connect the safety valve connection pipe to the safety valve outlet and tighten. The discharge pipe must have a continuous fall away from the appliance to outside and allow any water to drain away thereby eliminating the possibility of freezing. The discharge pipe must terminate in a position where any water - possibly boiling - discharges safely without causing damage or injury, but is still visible.

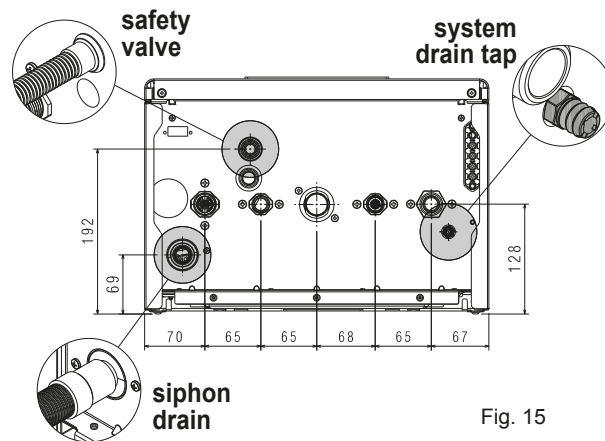

Fig. 15

4.3.6 CONDENSE PIPE

This appliance will - under normal operating conditions - produce condensate fluid that will require to be disposed of via the dwelling's waste water drainage system.

Vokera strongly recommends that the condensate pipe is connected to the internal waste water pipework in accordance with BS6798. BS6798 provides comprehensive instruction and advice on all permissible condensate disposal methods; notwithstanding this, it is essential that the following is strictly adhered to:

Use only plastic drainage pipe (minimum OD of 21.5mm). Horizontal runs must incorporate a minimum 45mm fall per metre, away from the appliance.

External pipework and/or pipework in unheated areas, must have a minimum OD of 32mm and be insulated with Class-O pipe insulation.

The route, type, and termination of the condensate disposal method, must not permit any spillage of condensate fluid, into the dwelling in the event of a blockage or freezing of the condensate pipework. Should it not be possible to route and terminate the condensate pipework internally using 'gravity discharge'; Vokera recommends that the Vokera condensate pump (code 404) be considered as an alternative solution.

Ensure that the end-user is aware of the effect/consequences of the condensate pipework becoming blocked or frozen.

4.4 INSTRUCTION FOR CONDENSATION EXHAUST CONNECTION

This product is designed to prevent the escape of gaseous products of combustion through the condensation drain pipe with which it is equipped, this is obtained by using a special siphon placed inside the appliance.

⚠ All components of the product condensation drain system must be properly maintained in accordance with the manufacturer instructions and cannot be modified in any way.

The condensation exhaust system downstream of the appliance must comply with the relevant legislation and standards.

The construction of the condensation exhaust system downstream of the appliance is the responsibility of the installer.

The condensation exhaust system must be dimensioned and installed in such a way as to guarantee the correct evacuation of the condensation produced by the appliance and/or collected by the evacuation systems of combustion products.

All the components of the condensation exhaust system must be made in a workmanlike manner using materials that are suitable for withstanding the mechanical, thermal and chemical stresses of the condensation produced by the appliance over time.

Note: if the condensation exhaust system is exposed to the risk of frost, always provide an adequate level of insulation of the pipe and consider any increase in the diameter of the pipe itself.

The condensation exhaust pipe must always have an adequate slope level to prevent the condensation from stagnating and its proper drainage.

The condensation exhaust system must have an inspectable disconnection between the condensation exhaust pipe of the appliance and the condensation exhaust system.

4.5 ELECTRICAL CONNECTIONS

The boiler is supplied with a short fly-lead. This lead can be used for connection to the electrical supply. Connect the fly-lead to a fused plug or fused isolator in the following way:

- brown wire to LIVE supply
- blue wire to NEUTRAL supply
- green/yellow to EARTH connection.

Insert the supplied 3-AMP fuse into the fused isolator or fused plug.

Should the fly-lead be unsuitable, refer to 4.7 for details on how to connect the electrical supply directly to the boiler.

The electrical supply must be as specified in section 3/3E. A qualified electrician should connect the appliance to the electrical supply. If controls - external to the appliance - are required, a competent person must undertake the design of any external electrical circuits, please refer to section 7 for detailed instructions. ANY EXTERNAL CONTROL OR WIRING MUST BE SERVED FROM THE SAME ISOLATOR AS THAT OF THE APPLIANCE. The supply cable from the isolator to the appliance must be 3-core flexible seized 0.75mm to BS 6500 or equivalent. Wiring to the appliance must be rated for operation in contact with surfaces up to 90 °C.

Low voltage connections

CE4 connector: use 4-poles connector, supplied as standard, for connections with ModBus 485 signal, see section 7 'WIRING DIAGRAMS' for advice on configuring the 485 BUS signal.

 We recommend using conductors with a section no larger than 0,5 mm².

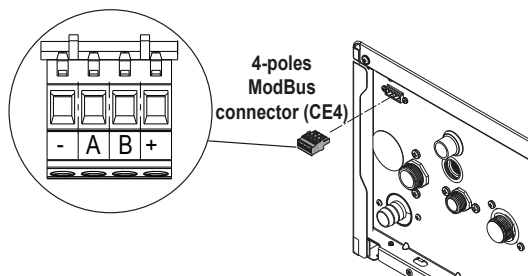

Connection on the main board: make the TA (ambient thermostat), OT+ and SE (external sensor) connections on X11 connector - see section "7 WIRING DIAGRAMS".

NOTE: when an OT+ remote control is connected to the system, if parameter 803=1 (SERVICE), the boiler display shows the following screen:

- In particular on the boiler display:
- it is no longer possible to set the boiler OFF/WINTER/SUMMER status (it is set by the OT+ remote control)
 - it is no longer possible to set the domestic hot water setpoint (it is set by the OT+ remote control)

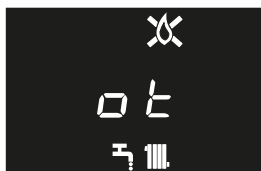

- the combination of the **A+B** keys remains active for the setting of the DOMESTIC HOT WATER COMFORT function
- the domestic hot water setpoint (I005) is displayed in the INFO menu
- the heating setpoint value calculated by the OT+ remote control (I017) is displayed in the INFO menu
- the heating setpoint set on the boiler display is used only if there are heat requests from the TA and the OT+ remote control does not have a request if the parameter: 311 = 1. This value is displayed in the INFO menu (I016).
- to activate the "Combustion analysis" function with an OT+ remote control connected, you must temporarily disable the connection by setting the parameter 803 = 0 (SERVICE); remember to reset this parameter once the function has finished.

Key 3 remains active for the visualisation of the INFO menu and the enabling of the SETTINGS menu.

4.6 CASING REMOVAL

To gain internal access to the appliance you must first remove the casing, proceed as outlined below:

- locate and unscrew the 2-screws that secure the outer casing to the appliance
- lift the casing upward to disengage it from the top locating hooks and then remove
- store the casing and screws safely until required. Re-fit in the reverse order
- press and hold the spring tabs on either side of the control panel where it meets the appliance side panels and gently lower it until it rests.

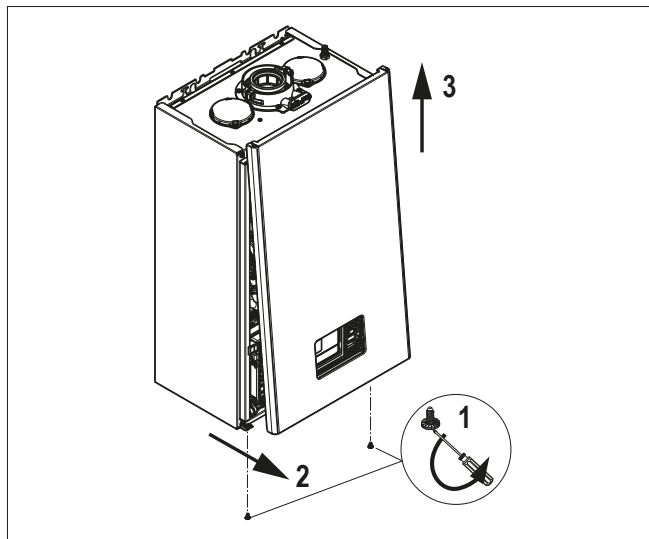

4.7 CONNECTING THE MAINS (230V) INPUT

Unhook and remove the terminal block cover (230V).

Pass the cable through the cable anchorage point. Connect the supply cable wires (LIVE, NEUTRAL, & EARTH) to their corresponding terminals (L, N, & E) on the appliance – high voltage – terminal block. When connecting the EARTH wire, ensure that it's left slightly longer than the others, this will prevent strain on the EARTH wire should the cable become taut. Do not remove the link wire unless additional external controls are to be fitted (see section 7) route the electrical supply via the cable entry/exit point and secure to the sleeve using an appropriate cable tie, and/or silicone sealant.

The appliance comes with a factory fitted link ('TA') to allow basic operation of the boiler via the mode selector switch. If it is anticipated that external controls will be required please refer to the wiring diagrams in section 7 for more detailed information.

NOTE

It is the installer's responsibility to ensure that the appliance is properly Earthed. Vokera Ltd. cannot be held responsible for any damages or injuries caused as a result of incorrect Earth wiring.

5 COMMISSIONING & OPERATION

NOTE: please refer to 3 - 3E and use the appropriate PPE when carrying out any of the actions or procedures contained within this section.

5.1 GAS SUPPLY INSTALLATION

Inspect the entire installation including the gas meter, test for tightness and purge. Refer to BS 6891 (I.S. 813 in ROI) for specific instruction.

5.2 THE HEATING SYSTEM

The appliance contains components that may become damaged or rendered inoperable by oils and/or debris that are residual from the installation of the system, consequently it is essential that the system be flushed in accordance with the following instructions.

5.3 INITIAL FILLING OF THE SYSTEM

Ensure both flow and return service valves are open, remove appliance casing as described in 4.6, identify the automatic air release valves (AAV) and loosen the dust cap/s by turning the cap anti-clockwise one full turn. Ensure all manual air release valves located on the heating system are closed. Connect the filling loop (not supplied), slowly proceed to fill the system by firstly opening the inlet valve connected to the flow pipe, and then turning the lever on the fill valve, to the open position. As water enters the system the pressure gauge will begin to rise. Once the gauge has reached 1 BAR close both valves and begin venting all manual air release valves, starting at the lowest first. It may be necessary to go back and top-up the pressure until the entire system has been filled. Inspect the system for water tightness, rectifying any leaks.

5.4 INITIAL FLUSHING OF THE SYSTEM

The whole of the heating system must be flushed both cold and hot as detailed in 5.6. Open all radiator or heating valves and the appliance flow & return service valve. Drain the boiler and system from the lowest points. Open the drain valve full bore to remove any installation debris from the boiler prior to lighting. Refill the boiler and heating system as described in 5.3.

5.5 PRELIMINARY CHECKS

Before starting up the boiler, check:

- confirm via the appliance data badge, that the appliance is suitable/configured for the gas type and electrical supply that has been provided to the appliance
- inspect the entire flue system and ensure that it has been installed in accordance with these instructions and the relevant standards that apply locally and/or nationally
- that the required clearances have been met in respect of the requirements for maintenance
- inspect the entire installation including the gas meter, test for tightness and purge. Refer to BS 6891 (I.S. 813 in ROI) for specific instruction
- ensure that the rated delivery of the gas meter is adequate enough to serve this appliance and any other gas appliance connected to the same meter
- ensure that the gas supply pipework is of adequate size to provide the maximum gas rate required by this appliance
- check that the siphon is completely filled with water, otherwise fill it up (see chapter 5.7).

5.6 FINAL FLUSHING OF THE HEATING SYSTEM

The system shall be flushed in accordance with BS 7593 (I.S. 813 ROI). Should a cleanser be used, it must be suitable for stainless-steel heat exchangers. It shall be from a reputable manufacturer and shall be administered in strict accordance with the manufacturers' instructions and the DWTA code of practice.

NOTE: Chemicals used to cleanse the system and/or inhibit corrosion must be pH neutral, i.e. they should ensure that the level of the pH in the system water remains neutral. Premature failure of certain components can occur if the level of pH in the system water is out-with normal levels.

5.6.1 INHIBITORS

See Section 3 "General Requirements".

5.7 FIRST COMMISSIONING

On first ignition after prolonged inactivity and after maintenance, before putting the appliance into operation it is essential to fill the condensate collection siphon by pouring about 1 litre of water into the boiler combustion analysis take-off and check:

- that the float within the trap is free and moving
- the correct flow of water from the boiler outlet discharge pipe
- there are no leaks of the condensate drain connection line.

Correct operation of the condensate drain circuit (siphon and pipes) requires that the condensate level does not exceed the maximum level (max). Prior filling of the siphon and the presence of the safety float inside the siphon is designed to prevent the escape of combustion gases into the environment.

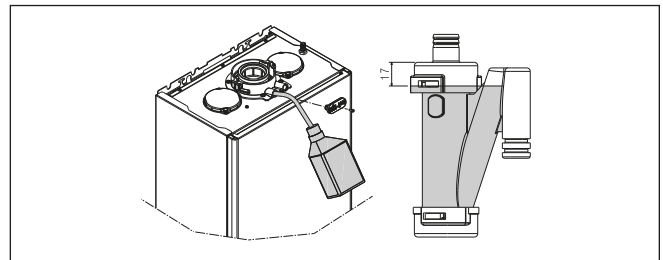

High efficiency mode

The boiler is equipped with an automatic function that is activated at the first power supply or after 60 days of non-use (electrically powered boiler). In this mode the boiler, for 60 minutes, limits the heating power to a minimum and the maximum DHW temperature to 55°C. Activating the chimney sweep temporarily disables this function.

During execution, the water pressure icon flashes and the display shows:

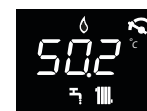

5.8 CONTROL PANEL

Your boiler is equipped with a large LCD display that indicates the appliance operating status.

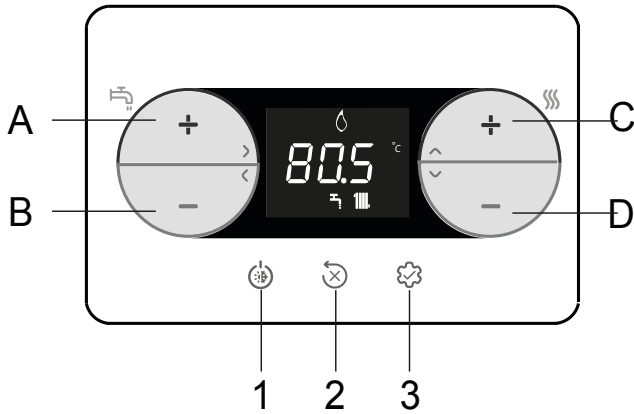

Note: values in thousands are displayed/100, for example 6500 rpm = 65.0

A and B	DHW setpoint adjustment Parameter selection
C and D	Heating setpoint adjustment Parameter setting
A+B	DHW Comfort menu (on the main page and with a status other than OFF)
B	Return to previous screen/cancel choice Press >2 sec to return to main page
1	Change operating status (OFF, SUMMER and WINTER)
2	Reset alarm (RESET) Interrupt venting cycle
3	Access to INFO menu Access to parameter setting menu Access to password entry page ENTER function
1+3	Key lock/unlock
2+3	When the boiler is OFF, activates combustion analysis (CO)

	Connection to a WIFI device
	Fault or deadline timer call for service
	In the event of a fault together with the icon (apart from flame and water alarms)
	Indicates presence of flame. In the event of a flame failure, the icon is
	Flashes with temporary water alarms, fixed with permanent alarm
	Present if heating mode is active; flashes with heating request in progress
	Present if DHW mode is active; flashes with DHW request in progress
°C - °F	Unit of measurement for temperature
rpm	Number of fan rotations
bar -psi	Pressure value

5.9 SETTING PASSWORD, ACCESS AND PARAMETER MODIFICATION

In the manual, whenever necessary

- enter the password to access the parameters

- choose, modify and/or confirm parameters

follow the sequences involved - see table - for more immediate action

Actions	Sequence
password entry	points 1 - 7
parameter choice	points 8-10
modify and confirm parameter	points 11-12a
exit without saving	point 12b
return to the main screen	point 13

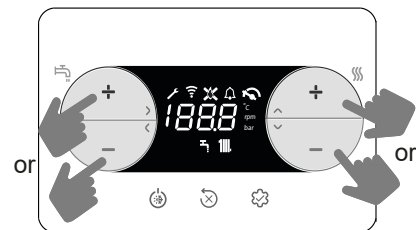

Key pressure =

- light: value progress of one unit at a time;

- prolonged: fast forward.

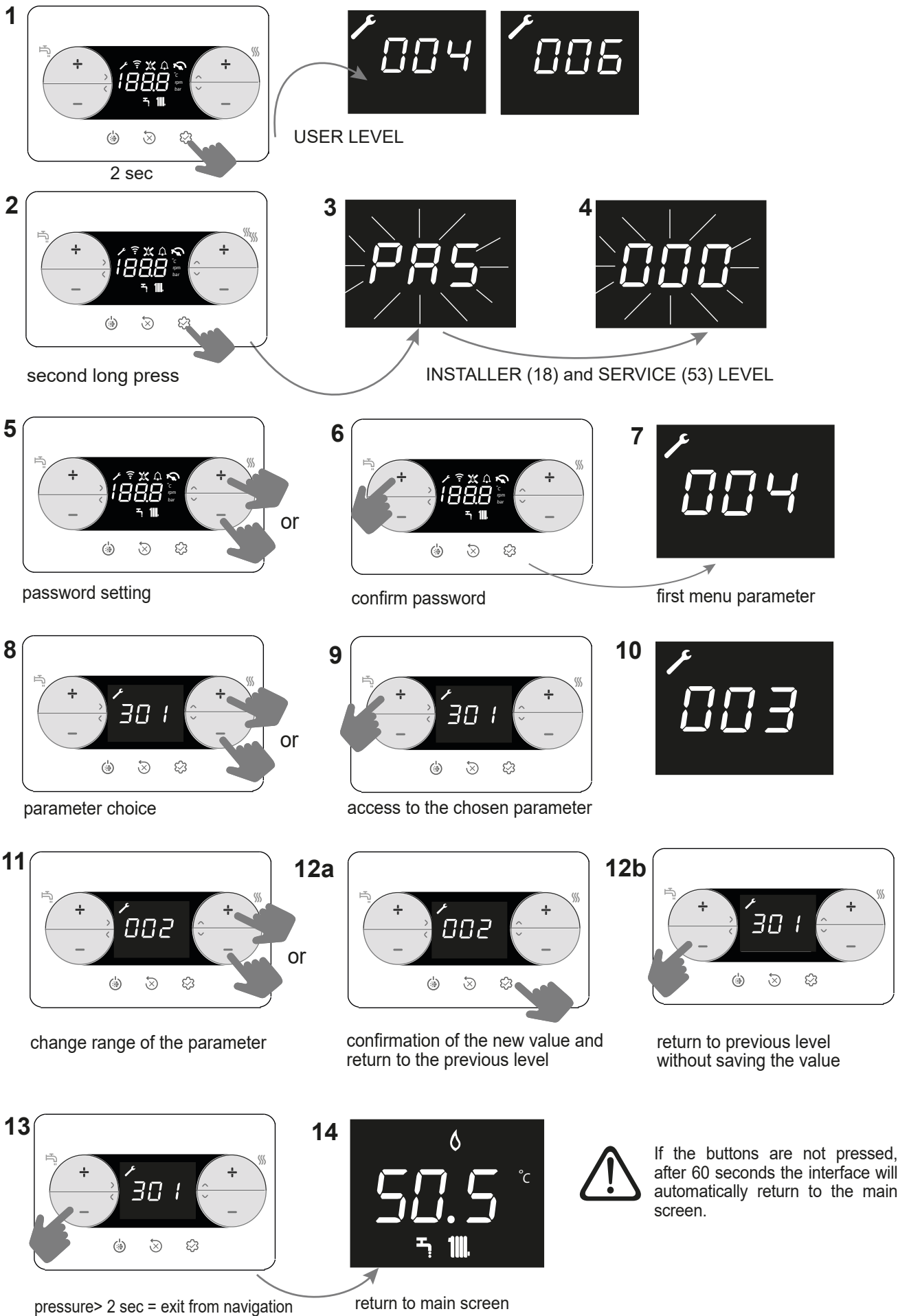

5.10 INITIAL LIGHTING

- Position the system's main switch to the "on" position.
- Open the gas tap to allow the fuel to flow.
- When the power is enabled, all the icons and segments will light up for 1 sec and the firmware revision will be visualised for 3 sec:



- The automatic venting cycle will then be launched (if it is enabled) and will last 4 min (for the details, refer to the paragraph "5.11 Venting cycle").
- The interface will show the status active in that moment.

- Adjust the ambient thermostat to the required temperature (~20°C) or, if the system is equipped with a timed thermostat or programmer, make sure it is "active" and adjusted (~20°C).

- Bring the boiler to WINTER or SUMMER mode.

5.11 VENTING CYCLE

Position the system's master switch to the "on" position. Every time the boiler is powered, a 4-minute venting cycle is run. The display shows . To interrupt the venting cycle, press the key shown in the figure below.

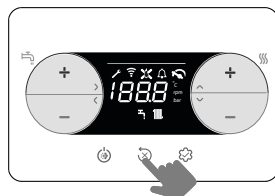
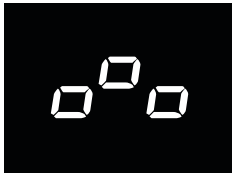

- When the venting cycle is running, all heat requests are inhibited apart from DHW unless the boiler is OFF.

The venting cycle can also be interrupted (if the boiler is not OFF) by a DHW request.

5.12 OPERATING STATUS

- Pressing key 1, the operating type switches cyclically between OFF - SUMMER - WINTER and then OFF again.

In standby, the display shows the system pressure. It shows the delivery temperature if there is a heating request, or the DHW temperature if there is a DHW request.

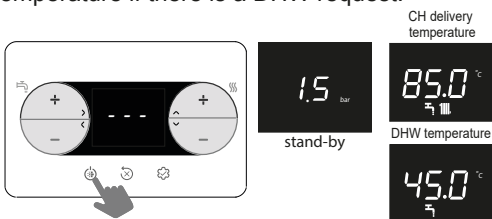

WINTER MODE

The boiler activates the heating and DHW function. The presence of the indicates a heat request and burner switch-on.

SUMMER MODE

The boiler activates the traditional DHW function.

WINTER

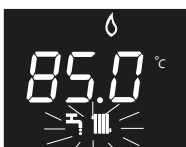

SUMMER

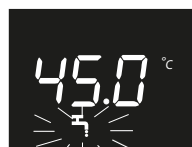

5.13 SETTING THE HEATING SETPOINT

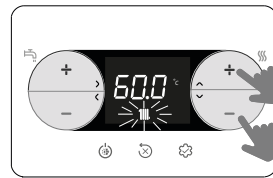

first press

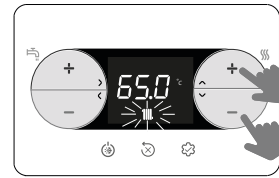

second press
set CH setpoint value
in steps of 0.5 °C

If no key is pressed for 5 sec, the set value is taken as the new heating setpoint.

5.14 SETTING THE HEATING SETPOINT WITH AN EXTERNAL PROBE

If an external probe is connected (optional) and temperature control is enabled (parameter 418=1), the delivery temperature value is selected automatically by the system, which quickly alters the ambient temperature on the basis of variations in the outdoor temperature.

Modifying the heating setpoint

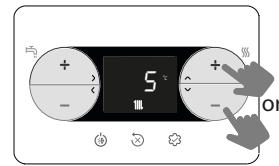
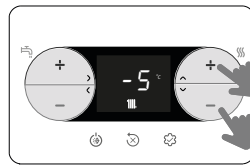

The setpoint correction is in the range (-5 to +5°C).
With parameter 418=0, the boiler works with a fixed point.

5.15 SETTING THE DHW SETPOINT

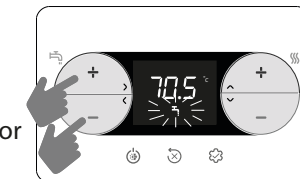

first press

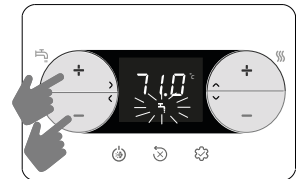

second press
set DHW setpoint value
in steps of 0.5 °C

If no key is pressed for 5 sec, the displayed value is taken as the new DHW setpoint.

5.16 SETTING THE THERMOREGULATION

The thermoregulation is only available if an external probe is connected, and is only active for the HEATING function.

THERMOREGULATION is enabled in the following way:

- set parameter 418 =1.

With 418 = 0 or the external probe disconnected, the boiler works with a **fixed point**. The temperature value measured by the external probe is visualised in "5.34 INFO menu" under item I009. The thermoregulation algorithm will not use the measured external temperature value directly, but rather a calculated external temperature that takes into account the building's insulation: in buildings that are well insulated, the outdoor temperature variations will have less impact than those that are poorly insulated by comparison. This value can be viewed in the INFO menu under item I010.

REQUEST FROM OT CONTROL

In this case, the delivery setpoint is calculated by chronothermostat on the basis of the external temperature value and the difference between the real ambient temperature and the required ambient temperature.

REQUEST FROM ROOM THERMOSTAT

In this case, the delivery setpoint is calculated by the adjustment board on the basis of the external temperature value, to obtain an estimated ambient temperature value of 20° (reference ambient temperature).

There are 2 parameters that compete to calculate the output setpoint:

- slope of the compensation curve (KT) - editable by technical staff
- offset on the reference ambient temperature - editable by the user.

TYPE OF BUILDING (parameter 432)

It is indicative of the frequency with which the value of the calculated outdoor temperature for thermoregulation is updated, a low value for this value will be used for buildings that have little insulation.

SENSOR REACTIVITY (parameter 433)

It is an indication of the speed with which variations of the measured outdoor temperature affect the calculated outdoor temperature value for thermoregulation, low values indicate high speeds.

CHOICE OF THE THERMOREGULATION CURVE (parameter 419)

The thermoregulation curve for heating maintains a theoretical temperature of 20°C indoors, when the outdoor temperature is between +20°C and -20°C. The choice of the curve depends on the minimum outdoor temperature envisaged (and therefore on the geographical location) and on the delivery temperature envisaged (and therefore on the type of system). It is carefully calculated by the installer on the basis of the following formula:

$$KT = \frac{T_{\text{delivery envisaged}} - T_{\text{shift}}}{20 - T_{\text{min. design external}}}$$

Tshift = 30°C standard system
25°C floor system

If the calculation produces an intermediate value between two curves, you are advised to choose the thermoregulation curve closest to the value obtained.

Example: if the value obtained from the calculation is 1.3, this is between curve 1 and curve 1.5. Choose the nearest curve, i.e. 1.5. The settable KT values are as follows:

- standard system: 1,0÷3,0
- floor system: 0,2÷0,8.

Parameter 419 can be used to set the required thermoregulation curve:

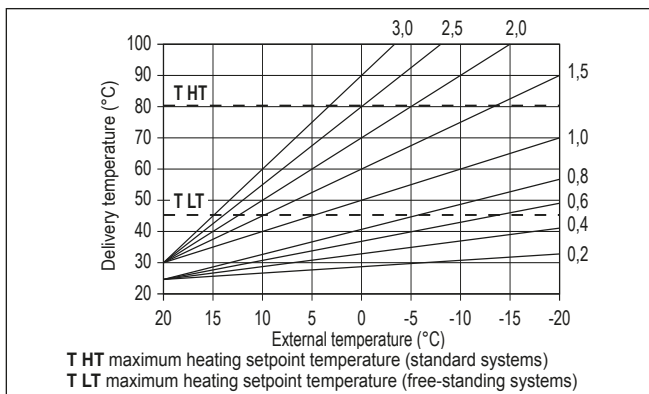

Offset on the reference ambient temperature

In any case, the user can indirectly modify the HEATING setpoint value by defining, for the reference temperature (20°C), an offset that can vary within the range -5 to +5 (offset 0 = 20°C). For the correction of the offset, refer to paragraph "5.14 Setting the heating setpoint with an external probe".

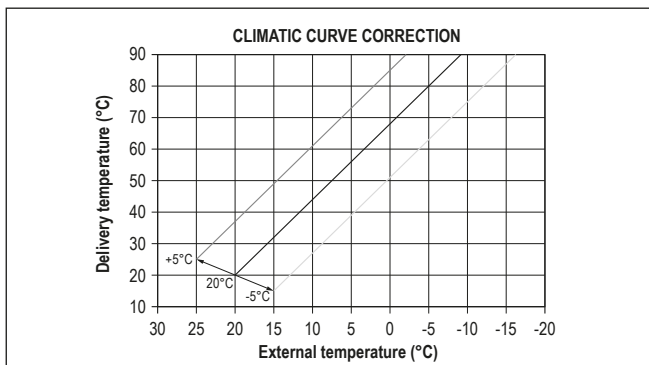

NIGHT-TIME COMPENSATION (parameter 420)

If a timer is connected to the AMBIENT THERMOSTAT input, parameter 420 can be used to enable night-time compensation.

- Set parameter 420 = 1

In this case, when the CONTACT is CLOSED, the heat request is made by the flow sensor, on the basis of the outdoor temperature, to obtain a nominal ambient temperature on DAY level (20 °C). The OPENING OF THE CONTACT does not produce a switch-off, but a reduction (parallel translation) of the climatic curve on NIGHT level (16 °C).

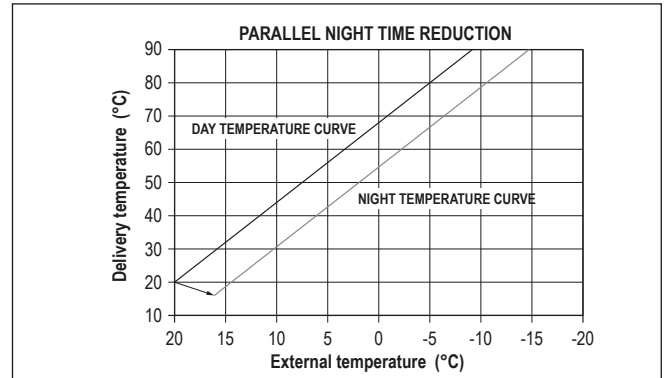

In this case too, the user can indirectly modify the HEATING setpoint value by defining an offset on the reference DAY temperature (20°C) or the reference NIGHT temperature (16°C) that can vary within the range [-5 to +5]. NIGHT COMPENSATION is not available if OT+ chrono is connected. For the correction of the offset, refer to paragraph "5.13 Setting the heating setpoint".

5.17 "DHW COMFORT" FUNCTION

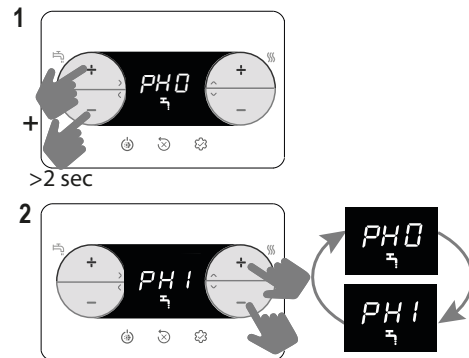

Function	Scrolling message
PH0	NO function active
PH1	PRE-HEATING function active

PH1 PRE-HEATING function

Set PH1 to activate the DHW pre-heating function on the boiler. This function keeps the water in the domestic hot water exchanger hot, to reduce standby times when a request is made. The function is not active when the boiler is OFF.

5.18 DHW SPECIAL FUNCTIONS

Parameter 511 is used to activate special functions during the modulation phase in DHW mode. These functions improve the boiler performance in particularly hard operating conditions (such as very high inlet water temperatures, very low flow rates, use in combination with solar storage tanks).

0	No special function active (default value)
3	Absolute DHW thermostats
4	Smart DHW anti-oscillation function
5	All previous functions active

ABSOLUTE THERMOSTATS function (3)

If this function is activated, the DHW thermostats for burner ON/OFF switch from the relative value to the absolute one.

ANTI-OSCILLATION function (4)

If this function is activated, the boiler self-configures to ABSOLUTE THERMOSTATS if the burner is OFF due to DHW over-temperature (with a request in progress). When the burner is OFF, the fan is kept at the minimum speed. The thermostats go back to being "correlated" at the end of the request.

5.19 FEEDER BOTTLE FUNCTION

The Feeder Bottle function is used to block the value of the DHW setpoint, to prevent anyone from accidentally modifying it. To activate the function from the setpoint DHW screen:

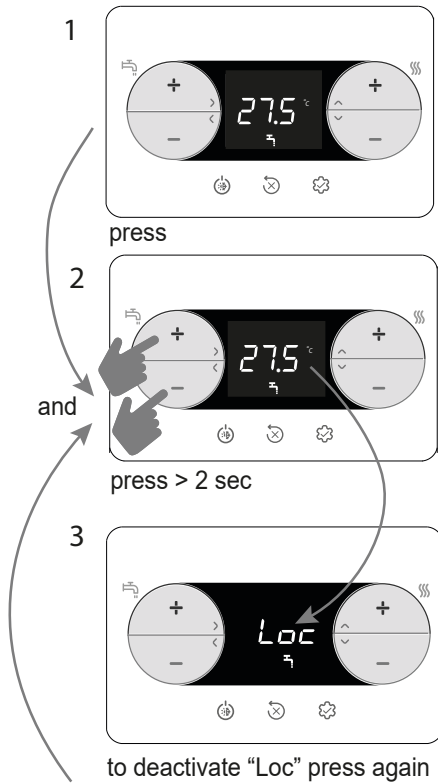

5.20 SCREED HEATER FUNCTION

With the system at a low temperature, the "screed heater" function enables a heating request with a delivery setpoint of 20°C in the initial zone. This value is then gradually increased as shown in the table below.

DAY	TIME	TEMPERATURE
1	0	20°C
	6	22°C
	12	24°C
2	18	26°C
	0	28°C
3	12	30°C
	0	32°C
4	0	35°C
5	0	35°C
6	0	30°C
7	0	25°C

This function lasts 168 hours (7 days).

To activate the screed heater function:

- set the boiler to OFF (because this function is only available in this mode)
- set 409 = 1, the display will show

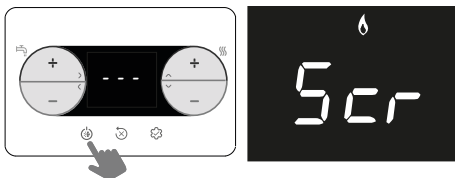

Once activated, this function takes maximum priority. If there is a power failure and reset, the function will resume from the point where it was interrupted.

The screed heater function can be disabled by bringing the boiler to a condition other than OFF, or by setting 409 = 0.

In item I001 of the INFO menu, you can see the number of hours that have elapsed since the function was activated.

5.21 COMBUSTION ANALYSIS

Checks to verify the adjustments of the CO₂ values in relation to the reference parameters (given in the tables below) must be carried out with the casing closed. If the casing is opened, the values will have to be reduced by about 0.2% depending on the installation configuration (the type and length of the discharge and suction pipes).

Combustion control sequence

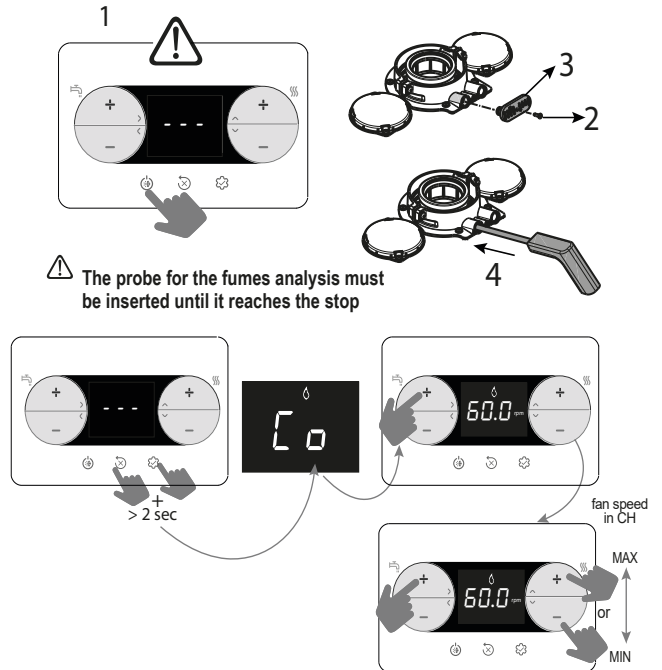

The displayed value refers to the number of revolutions divided by 100.

- Set the maximum rpm value

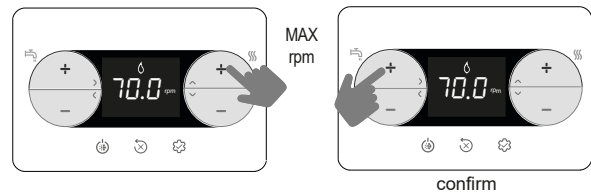

The boiler works at the maximum power level.

- Check the analyser to ensure the max CO₂ value complies with the indication given in the table. If the value is different, calibrate the gas valve - see paragraph "5.23 Gas valve calibration".

table 1	CO ₂ max	METHANE GAS (G20)	LPG (G31)	
	26C	9,0	10,0	%
	30C	9,0	10,0	%

- Set the minimum rpm value

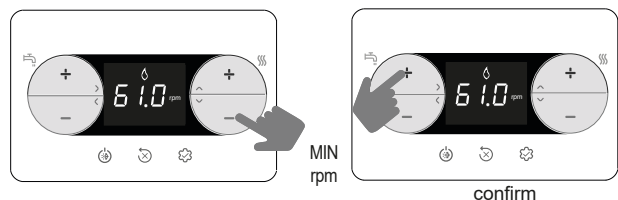

The boiler works at the minimum power level.

- Check the analyser to ensure the min CO₂ value complies with the indication given in the table. If the value is different, calibrate the gas valve - see paragraph "5.23 Gas valve calibration".

table 2	CO ₂ min	METHANE GAS (G20)	LPG (G31)	
	26C	9,0	10,0	%
	30C	9,0	10,0	%

Make sure the flue gas temperature value, read in info I008 (see “5.34 INFO menu”), is coherent (with a tolerance $\pm 5^{\circ}\text{C}$) with the value measured by the analyser.

After completing the check:

- quit the function by pressing

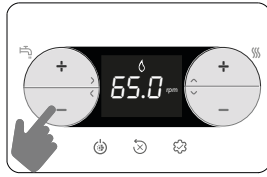

exit function

- reposition the previously removed components
- set the boiler to the required operating mode, depending on the season
- regulate the heat request temperature values according to the customer's needs.

! When the combustion analysis function is active, all heat requests are inhibited and the message “CO” appears on the display.

IMPORTANT

The combustion analysis function is active for max. 15 minutes; the burner shuts down if a delivery temperature of 95°C is reached. It will ignite again when the temperature falls below 75°C .

! The combustion analysis function is usually carried out with the 3-way valve on heating. The 3-way valve can be switched to DHW by generating a DHW request at the maximum output while the function itself is still active. In this case, the DHW temperature will be limited to a maximum value of 65°C . Wait for the burner to fire.

5.22 ADJUSTMENTS

The boiler has already been adjusted by the manufacturer. If the adjustments need to be made again however e.g. following extraordinary maintenance, after the replacement of the gas valve, after conversion from methane gas to LPG or vice versa, follow the procedures described below. The adjustment of the maximum and minimum output, maximum heating and slow ignition must be made in the sequence indicated, and by qualified personnel only:

- power up the boiler
- set the parameters

306	minimum fan speed
307	maximum fan speed
308	slow ignition
309	maximum fan speed for heating
313	ignition speed in restart

table 3	MAX. FAN RPM	METHANE GAS (G20)	LPG (G31)	
	26C: CH - DHW	7.000 - 8.700	6.900 - 8.500	rpm
	30C: CH - DHW	6.900 - 8.300	6.800 - 7.900	rpm

table 4	MIN. FAN RPM	METHANE GAS (G20)	LPG (G31)	
	26C	1.500	2.050	rpm
	30C	1.500	1.700	rpm

table 5	FAN RPM SLOW IGNITION	METHANE GAS (G20)	LPG (G31)	
	26C - 30C	5.500	5.500	rpm

5.23 GAS VALVE CALIBRATION

Run the CO₂ check procedure as explained in paragraph “5.21 Combustion analysis”. If the values need to be modified, proceed as follows:

- check the CO₂ adjustment values with the casing closed
- remove the casing as explained in paragraph “4.6 CASING REMOVAL”
- check the CO₂ adjustment values again, with the casing open
- on the basis of the difference in values with the casing closed and open, if necessary bring the CO₂ to the value shown in the table (1 and 2) - (minus) the difference found. Example:
 - CO₂ value measured with the casing closed = 8,5%
 - CO₂ value measured with the casing open = 8,3%

- value to be set for CO₂ with the casing open = 8,8%
- value to be set for CO₂ with the casing closed = 9,0%
- to adjust the CO₂ value:
 - rotate the max. power adjustment screw clockwise to reduce the value, or anti-clockwise to increase it
 - rotate the min. power adjustment screw clockwise to increase the value, or anti-clockwise to reduce it
- with the casing open and after adjusting the CO₂ value at the minimum power, check the adjustment of the CO₂ at the maximum power again
- after completing the adjustments, replace the casing and check the CO₂ corresponds to the value shown in the table 1 and 2.

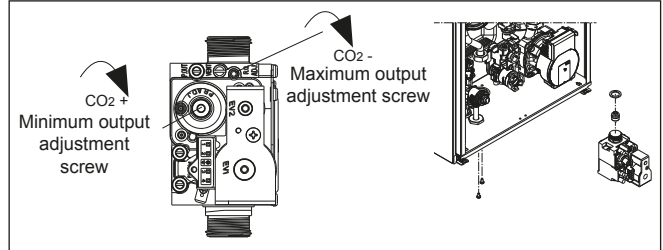

5.24 RANGE RATED

This boiler can be adapted to the heating requirements of the system:

- power up the boiler
- set the parameter

310	Range rated
------------	-------------

- Set the heating value required (see chart) (rpm) and confirm.

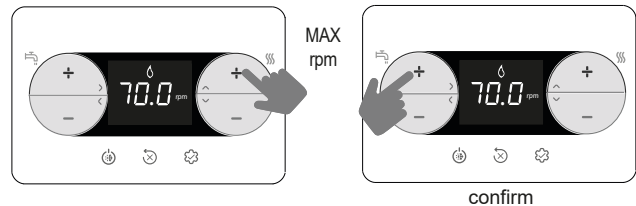

Record the new set value in the table on the back cover of this manual. For subsequent controls and adjustments, refer to the set value.

! The calibration does not entail the ignition of the boiler. The boiler is supplied with the adjustments shown in the technical data table. Depending on requirements however, this value can be modified by referring to the graph below.

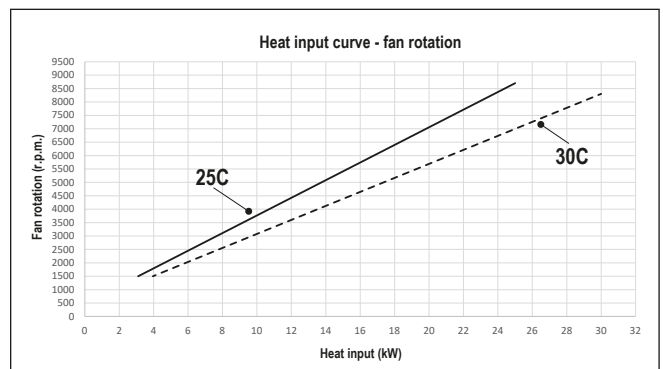

5.25 FAULTS AND REPORTING

If there is a fault, an error code “Axx” is shown on the display. In certain cases, the error code is accompanied by an icon:

FAULTS	ICONS DISPLAYED
flame failure A10	
all faults except flame failure and water pressure	
water pressure	

Reset function

To reset boiler operation in the event of a fault, press:

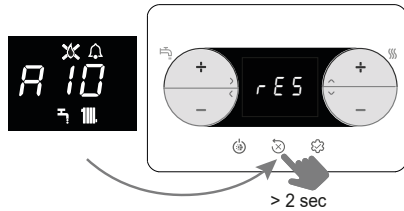

If the correct operating conditions have been restored, the boiler will start up again automatically. In the presence of a remote control, a maximum of 5 consecutive unlocking attempts are available. In this case, by pressing the boiler restores the initial attempts.

If the attempts to reset the boiler do not work, contact the Technical Assistance Centre.

FAULT A41: if the pressure value falls below the 0.3 bar safety value, the boiler shows the fault code A41 for a transitory time of 10 min. If the fault still persists after this time, fault code A40 will appear.



With fault A40 on the boiler it is necessary to top-up the system pressure in the following way:

- open the filling valve slowly until you hear water entering the system
- close the filling valve, access the Info menu ("5.34 INFO menu", item I018) to check that the pressure value reaches 1-1.5 bar:

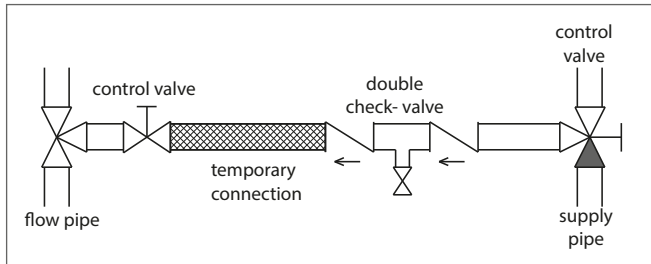

Press to restore operation. After filling, run a venting cycle. If the pressure drop is very frequent, contact the Technical Assistance Centre.

Fault A60: indicates a fault on the DHW probe; notwithstanding this, the appliance will continue to provide hot water at approximately 50°C. The intervention of the Technical Assistance Centre is required.

Fault A91: the boiler has a self-diagnosis system that signals the need to clean the primary heat exchanger on the basis of the total number of hours in certain operating conditions (alarm code A91). Fault A91 occurs when the counter exceeds the value of 2500 hours; this value can be checked in the "5.34 INFO menu", item I015 (visualization/100, example 2500h = 25).

After cleaning (using the special kit supplied as an accessory), reset the total hours counter by bringing parameter 312 = 1. NOTE: The meter resetting procedure should be carried out after each in-depth cleaning of the primary exchanger.

5.26 SAFETY STOP

If faults arise during ignition or operation, the boiler makes a "SAFETY STOP". The display shows the error code in question. For the details, refer to "5.25 Faults and reporting".

Reset function

Contact the local Technical Assistance Centre if the reset attempts fail to reactivate normal operation.

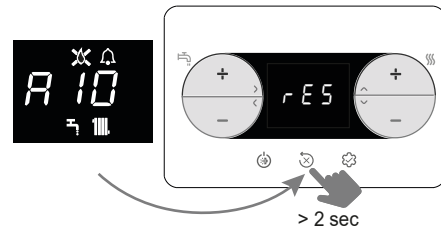

ERROR CODE	ERROR MESSAGE	DESCRIPTION OF TYPE OF ALARM
A10	Flame lockout Condensate drain obstructed Flue gas exhaust/air suction obstructed	definitive
A11	Extraneous flame	transitional
A20	Limit thermostat	definitive
A30	Fan fault	definitive
A40	Fill the system	definitive
A41	Fill the system	transitional
A42	Pressure transducer fault	definitive
A60	DHW probe fault	transitional
A70	Flow sensor fault Flow sensor overtemperature Flow/return sensor differential	transitional definitive definitive
A80	Return probe fault Return probe overtemperature Return-flow sensor differential	transitional definitive definitive
A90	Flue gas probe fault	transitional
A91	Clean primary heat exchanger	transitional
A58	Low power supply voltage	transitional
A59	High power supply voltage	transitional
CFS	Call Service	signal
SFS	Stop for Service	definitive
FIL	Low pressure - check system	signal
>3.0 bar	High pressure - check system	signal

5.27 KEYBOARD LOCK FUNCTION

To lock the keys

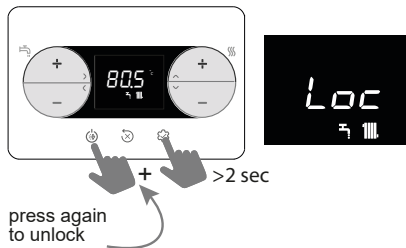

If there is a fault, key 2 remains active to allow the alarm to be reset.

5.28 ALARM HISTORY

The alarm history is active with parameter 701=1 (SERVICE). Alarms can be viewed:

- info menu (from I039 to I043), in chronological order, from the oldest to the most recent, up to a maximum of 5.
- on OT+ remote control, if connected.

When an alarm occurs several times in a row, it is stored only once.

To reset the alarm, follow the instructions provided in paragraph "5.26 Safety stop".

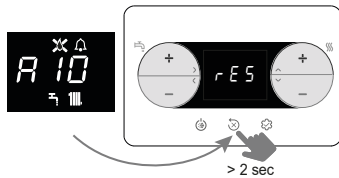

5.29 REPLACING THE BOARD

If the main PCB is replaced, it may be necessary to reprogram the configuration parameters. In this case, refer to the parameters table to see the board default values, the factory set values, and the personalised values. The parameters that must be checked and reset if necessary after replacing the board are: 301 - 302 (SERVICE) - 306 - 307 - 308 - 309 - 310 - 708.



708 (remember to set the parameter to 0).

5.30 TEMPORARY SWITCH-OFF

In the event of temporary absences (weekends, short breaks, etc.) set the status of the boiler to OFF.

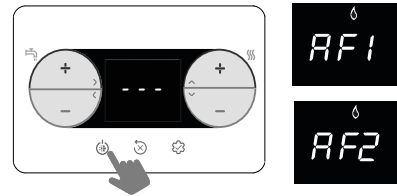

While the electrical supply and the fuel supply remain active, the boiler is protected by the systems:

- **heating anti-freeze:** this function is activated if the temperature measured by the flow sensor drops below 5°C. A heat request is generated in this phase, with burner ignition at the minimum output (then maintained until the delivery water temperature reaches 35°C); the display shows AF1
- **DHW anti-freeze:** this function is activated if the temperature measured by the domestic hot water probe drops below 5°C. A heat request is generated in this phase, with burner ignition at the minimum output (then maintained until the delivery water temperature reaches 55°C); the display shows AF2
- **circulator anti-locking:** The circulator activates every 24 hours of stop for 30 seconds.

5.31 SWITCHING OFF FOR LENGTHY PERIODS

If the boiler is not used for a long time, the following operations must be carried out:

- set the OFF status
- isolate the appliance from the electrical supply
- turn off the fuel and water taps of the heating and domestic hot water system.

In this case, the anti-freeze and anti-blocking systems are deactivated. Drain the heating and domestic water system if there is any risk of freezing.

5.32 PROGRAMMABLE PARAMETERS

A list of the programmable parameters is given below: USER (level always available) and INSTALLER (access with password 18); for a detailed explanation of the parameters, refer to paragraph "5.33 Parameters description".



Some information might not be available depending on the access level, machine status or system configuration.

USER PARAMETERS 		Value		Password level	Value set in the factory	Personalised values
		min	max			
	SETTINGS					
004	MEASUREMENT UNIT	0	1	USER	0	

INSTALLER PARAMETERS		Value		Password level	Value set in the factory	Personalised values
		min	max			
	CONFIGURATION					
301	HYDRAULIC CONFIG.	0	4	INSTALLER	2 *	
306	MIN FAN SPEED	1.200	3.600	INSTALLER	see technical data table	
307	MAX FAN SPEED	3.700	9.999	INSTALLER	see technical data table	
308	SLOW IGNITION ADJUSTMENT	MIN	MAX	INSTALLER	see technical data table	
309	MAX CH FAN SPEED	MIN	MAX	INSTALLER	see technical data table	
310	RANGE RATED	MIN	MAX_CH	INSTALLER	see technical data table	
311	AUX OUTPUT	0	2	INSTALLER	0	
312	FLUE GAS COUNTER RESET	0	1	INSTALLER	0	
313	IGNITION SPEED IN RESTART AFTER SHUTDOWN DUE TO TEMPERATURE	MIN FAN SPEED	SLOW IGNITION ADJUSTMENT	INSTALLER	3.600 rpm	
	HEATING					
405	SET PUMP	60	100	INSTALLER	85	
408	OT+ CASCADE	NOT APPLICABLE ON THIS MODEL				
409	SCREED HEATER	0	1	INSTALLER if boiler in OFF and LT systems	0	
410	HEATING OFF	0 min	20 min	INSTALLER	3 min	
411	RESET HEATING TIMES	0	1	INSTALLER	0	
415	MAIN LT ZONE	0	1	INSTALLER	0	
416	MAX TEMP (MAIN ZONE)	MIN TEMP (MAIN ZONE)	HT: 80.5 - LT: 45.0	INSTALLER	HT: 80.5 - LT: 45.0	
417	MIN TEMP (MAIN ZONE)	20	MAX TEMP (MAIN ZONE)	INSTALLER	HT: 40 - LT: 20	
418	THERMOREGULATION (MAIN ZONE)	0	1	INSTALLER if ext. probe present	0	
419	CURVE SLOPE (MAIN ZONE)	HT: 1.0 - LT: 0.2	HT: 3.0 - LT: 0.8	INSTALLER only if 418 = 1	HT 2.0 - LT 0.4	
420	NIGHT-TIME COMP. (MAIN ZONE)	0	1		0	
432	BUILDING TYPE	5 min	20 min		5 min	
433	EXTERNAL PROBE REACTIVITY	0	255		20	
	DHW					
508	MIN DHW TEMP.	37,5 °C	49,0 °C	INSTALLER	37,5°C	
509	MAX DHW TEMP.	49,0 °C	60,0 °C	INSTALLER	60,0°C	
511	SPEC. DHW FUNCTIONS	0	5	INSTALLER	0	

HT: high temperature - LT: low temperature

SERVICE PARAMETERS		Value		Password level	Value set in the factory	Personalised values
		min	max			
	CONFIGURATION					
302	PRESSURE TRANSD. TYPE	0	1	SERVICE	1	
303	ENABLE FILLING	0	1	SERVICE	0	
304	PRESSURE AT START OF FILLING	NOT AVAILABLE ON THIS MODEL				
305	VENTING CYCLE	0	1	SERVICE	1	
	HEATING					
401	HIGH TEMP HYSTERESIS OFF	2	10	SERVICE	5	
402	HIGH TEMP HYSTERESIS ON	2	10	SERVICE	5	
403	LOW TEMP HYSTERESIS OFF	2	10	SERVICE	3	
404	LOW TEMP HYSTERESIS ON	2	10	SERVICE	3	
	DHW					
510	DHW DELAY	0 sec	60 sec	SERVICE	0 sec	
512	DHW POST-CIRC. ON HEATING RETURN	0	1	SERVICE	0	
513	RETURN POST-CIRC TIME	1	255	SERVICE	6	
	TECHNICAL					
701	ALARM HISTORY ACTIVATION	0	1	SERVICE	0 (the value automatically changes to 1 after 2 hours of operation)	
706	SERVICE CALL FUNCTION	0	2	SERVICE	2	
707	SERVICE DEADLINE	0	255	SERVICE	52	
708	HIGH EFFICIENCY MODE	0	1	SERVICE	0	
	CONNECTIVITY					
801	BUS 485 CONFIG.	NOT AVAILABLE ON THIS MODEL				
803	OT+ CONFIG.	0	1	SERVICE	1	

*301: 0 = HEATING ONLY - 1 = INSTANTANEOUS FLOW SWITCH - 2 = INSTANTANEOUS FLOW METER - 3 = STORAGE TANK WITH PROBE
4 = STORAGE TANK WITH THERMOSTAT

5.33 PARAMETERS DESCRIPTION

Some of the following functions may not be available depending on the machine type and access level.

PARAMETER	DESCRIPTION
004	To alter the measurement unit: 0 = METRIC measurement units / 1 = IMPERIAL measurement units. The figures are expressed in decimal format (one figure) for values between -9°C and +99°C, and in whole number format for values ≤ -10°C and ≥ 100°C. The visualisation in °F (Fahrenheit) is always expressed in whole number format.
301	To set the type of hydraulic configuration for the boiler: 0 = HEATING ONLY - 1 = INSTANTANEOUS FLOW SWITCH - 2 = INSTANTANEOUS FLOW METER - 3 = STORAGE TANK WITH PROBE - 4 = STORAGE TANK WITH THERMOSTAT Factory value = 2 (do not alter). If the electronic board is replaced, make sure this parameter is set at 2
302	To set the type of water pressure transducer: 0 = water pressure switch - 1 = pressure transducer Factory value = 1 (do not alter). If the electronic board is replaced, make sure this parameter is set at 1.
303	To enable the "semi-automatic filling" function when a pressure transducer and filling solenoid valve are installed in the boiler. Factory value = 0 (do not alter). If the electronic board is replaced, make sure this parameter is set at 0.
304	Only appears if 303 = 1 NOT AVAILABLE ON THIS MODEL.
305	To disable the vent cycle function. Factory value = 1. Set the parameter at 0 to disable the function.
306	To alter the minimum number of fan rotations.
307	To alter the maximum number of fan rotations.
308	To regulate slow ignition (it can be programmed within the range 306 - 307).
309	To alter the maximum fan rpm in heating mode (it can be programmed within the range 306 - 307).
310	To modify the heat output in heating mode. Factory value = 309, but it can be programmed within the range 306 - 309. For more details about the use of this parameter, refer to paragraph "5.24 Range rated".
311	To configure the operation of a supplementary relay (only if board BE09 (accessory kit) is installed) in order to bring a phase (230V AC) to a second heating pump (supplementary pump) or to a zone valve. Factory value = 0, but it can be programmed within the range 0 - 2 with the following meaning: 311= 0 - control depends on the configuration of the wiring of the BE09 board (jumper cut: supplementary pump - jumper present: zone valve) 311= 1 - control of the zone valve 311= 2 - control of the supplementary pump
312	Used to reset the operating hours counter in certain conditions (for more details, see "5.25 Faults and reporting", fault A91). Factory value = 0. Bring the value to 1 to reset the flue gas probe hour counter after the cleaning of the primary heat exchanger. When the reset procedure has been completed, the parameter will return automatically to 0.
313	This parameter allows the regulation of slow ignition in burner re-ignitions following shutdowns due to the set point temperature being reached. Adjustment is possible between the minimum fan speed value (306) and the speed value during slow ignition (308)
401	For high temperature systems, this parameter allows the setting of the hysteresis value used by the adjustment board to calculate the delivery temperature for burner switch-off. SWITCH-OFF TEMPERATURE = HEATING SETPOINT + 401. Factory value = 5°C, but it can be set within the range 2 - 10°C.
402	For high temperature systems, this parameter allows the setting of the hysteresis value used by the adjustment board to calculate the delivery temperature for burner ignition: IGNITION TEMPERATURE = HEATING SETPOINT - 402. Factory value = 5°C, but it can be set within the range 2 - 10°C.
403	For low temperature systems, this parameter allows the setting of the hysteresis value used by the adjustment board to calculate the delivery temperature for burner switch-off: SWITCH-OFF TEMPERATURE = HEATING SETPOINT + 403. Factory value = 3°C, but it can be set within the range 2 - 10°C.
404	For low temperature systems, this parameter allows the setting of the hysteresis value used by the adjustment board to calculate the delivery temperature for burner ignition: IGNITION TEMPERATURE = HEATING SETPOINT - 404. Factory value = 3°C, but it can be set within the range 2 - 10°C.
405	The pump speed is PROPORTIONAL to that of the fan and in DHW it is always at max. The parameter can be set in the range 60-100: 100 = no modulation - 60 = max modulation - 85 = default value.
408	Used to set the boiler for cascade applications via an OT+ signal. Not applicable with this boiler model.
409	Used to activate the screed heater function (for more details, refer to paragraph "5.20 Screed heater function"). Factory value = 0, with the boiler OFF. Set the value at 1 to activate the screed heater function on the low temperature heating areas. The parameter returns automatically to 0 when the screed heater function ends, but the function can also be interrupted by manually setting the value at 0.
410	Used to modify the forced heating off timer with regards the delay time for re-igniting the burner if it is OFF because the heating temperature has been reached. Factory value = 3 minutes, but it can be set at a value between 0 and 20 min.
411	Used to annul the HEAT TIME RESET function and REDUCED MAX. HEATING OUTPUT TIMER, during which the fan speed is limited to a range between the minimum and 60% of the max. heating output set, with a 10% increase every 15 minutes. Factory value = 0. Set at 1 to reset the timer.
415	Used to specify the type of area to be heated. Choose from the following options: 0 = HIGH TEMPERATURE (factory setting) 1 = LOW TEMPERATURE
416	Used to specify the maximum heating setpoint value that can be set: range 20°C - 80.5°C, default 80.5°C for high temperature systems range 20°C - 45°C, default 45°C for low temperature systems Note: the value of 416 cannot be lower than 417.
417	This parameter is used to specify the minimum heating setpoint value that can be set: range 20°C - 80.5°C, default 40°C for high temperature systems range 20°C - 45°C, default 20°C for low temperature systems Note: the value of 417 cannot be higher than 416.
418	Used to activate temperature control when the system is connected to an outdoor temperature sensor. Factory value = 0 (the boiler always works with a fixed point). If the parameter is set at 1 and an outdoor temperature sensor is connected, the boiler works in temperature control mode. If the outdoor temperature sensor is disconnected, the boiler always works with a fixed point. See paragraph "5.16 Setting the thermoregulation" for more details about this function.
419	Used to set the number of the compensation bend used by the boiler in temperature control mode. Factory value = 2.0 for high temperature systems, and 0.5 for low temperature systems. The parameter can be programmed within the range 1.0 - 3.0 for high temperature systems, or 0.2 - 0.8 for low temperature systems. See paragraph "5.16 Setting the thermoregulation" for more details about this function.
420	Activates the "night-time compensation" function. The default value is 0. Set at 1 to activate the function. See paragraph "5.16 Setting the thermoregulation" for more details about this function.

432	Frequency with which the value of the calculated outdoor temperature for thermoregulation is updated, a low value for this value will be used for buildings that have little insulation.
433	Frequency for the reading of the outdoor temperature value by the probe.
501-507	Functions linked to the availability of a storage tank. NOT AVAILABLE ON THIS MODEL
508	To set the minimum DHW setpoint
509	To set the maximum DHW setpoint
510	Only visible when parameter 511= 2 or 5. A delay - in seconds - is imposed on pump and fan activation when there is a DHW request.
511	Enabling of special DHW functions: 0 = no function • 1 = NOT USED • 2 = NOT USED • 3 = absolute DHW thermostats • 4 = smart anti-oscillation DHW function • 5 = all the previous functions active
512	This value can be used to enable/disable the DHW post-circulation function with inhibition of heating start-up.
513	This value sets the duration of the DHW post-circulation when the DHW post-circulation function with inhibition of heating start-up is enabled.
701	Used to activate the storage of an alarm history. Default 0; the value automatically changes to 1 after 2 hours of operation
706	This parameter allows periodic control of the boiler according to an operating period set in parameter 707. There are three setting values: 0 = function disabled 1 = function enabled according to the following rule: if 707 < 4 the display shows the CFS signal if 707 = 0 the display shows the SFS (STOP FOR SERVICE) signal which indicates the permanent inhibition of all requests for heating and domestic hot water. Not resettable 2 = function enabled: when 707 = 0 the display shows the CFS signal without any stop of operation In this condition, the INFO menu (line I044) displays the number of days that have passed since the CFS signal appeared (707 = 0)  The CFS signal occurs at 10 min intervals for the duration of 1 min, 1 month before the end of the period set in parameter 707.
707	Fixed operating period for the service call (parameter 706).
708	Automatic function that is activated at the first power supply or after 60 days of non-use (electrically powered boiler). In this mode the boiler, for 60 minutes, limits the heating power to a minimum and the maximum DHW temperature to 55°C. Activating the chimney sweep temporarily disables this function. During execution, the water pressure icon flashes. 0 = FACTORY VALUE, high efficiency mode disabled.
801	FUNCTION NOT AVAILABLE ON THIS MODEL
803	This parameter is used to enable the remote control of the boiler via an OpenTherm device: 0 = OT+ function disabled (remote boiler control via an OT+ device is not possible). If this parameter is set at 0, the OT+ connection (if present) will be immediately interrupted 1 = FACTORY VALUE. OT+ function enabled (an OT+ device can be connected for remote boiler control). When an OT+ device is connected to the boiler, the message "Ot" appears on the display.

5.34 INFO MENU

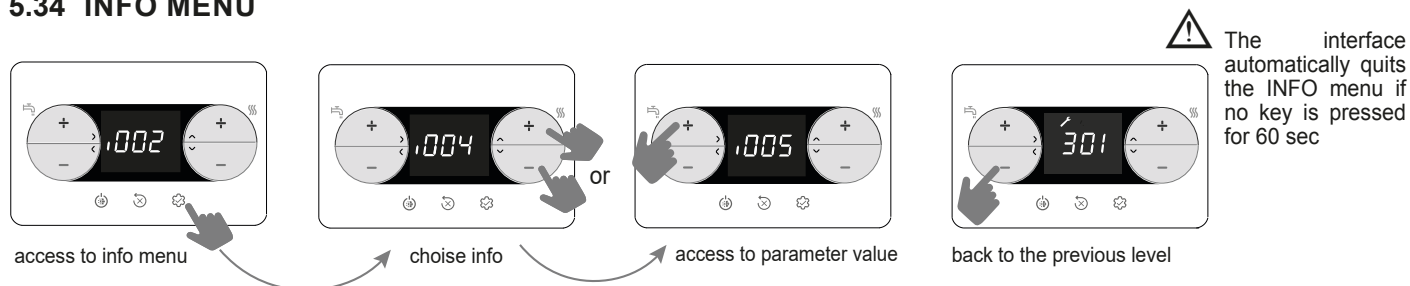

PARAMETER NAME		DESCRIPTION
I001	Screed heater hours	Number of hours of screed heater function activation
I002	Delivery probe	Boiler delivery probe value
I003	Return probe	Boiler return probe value
I004	Domestic hot water probe	DHW probe value with boiler in instantaneous mode
I005	OT+ DHW setpoint	DHW setpoint sent by OT+ remote control to the boiler
I008	Flue gas probe	Flue gas probe value
I009	External probe	Instantaneous external probe value
I010	External temperature for thermoregulation	Filtered external probe value used in the temperature control algorithm to calculate the heating setpoint
I011	DHW flow rate	DHW setpoint (only with OT+ connection)
I012	Fan rotations	Number of fan rotations (rpm)
I015	Flue gas probe counter	Number of operating hours of the heat exchanger in "condensing mode" (values in thousands are displayed/100)
I016	Delivery setpoint (main zone)	Delivery setpoint for the main zone
I017	OT+ CH setpoint	CH setpoint sent by OT+ remote control to the boiler
I018	System pressure	The system pressure level
I028	Ionization current	Instantaneous ionization current detected by the detection electrode
I029	High efficiency mode	Indicates when the high efficiency mode is running
I032	DHW Comfort	DHW Comfort mode
I033	DHW special functions	Special functions active for high DHW inlet temperatures
I034	ID board	Identification of the electronic board
I035	FW board revision	Firmware revision on the electronic board
I038	WiFi pendrive radio signal	Not available
I039	Alarm history 1 (the oldest)	List of the last five alarms recorded
I040	Alarm history 2	
I041	Alarm history 3	
I042	Alarm history 4	
I043	Alarm history 5 (the latest)	
I044	Reporting number of days for CFS	Number of days that have passed since the CFS signal appeared (707 = 0)

5.35 FINAL CHECKS

- ENSURE ALL TEST NIPPLES ON THE APPLIANCE GAS VALVE ARE TIGHT AND CHECKED FOR TIGHTNESS.
- ENSURE THE APPLIANCE FLUE SYSTEM IS FITTED CORRECTLY AND IS PROPERLY SECURED.
- ENSURE ALL PIPE WORK IS RE-CHECKED FOR TIGHTNESS.
- RE-FIT APPLIANCE CASING.
- COMPLETE BENCHMARK CHECKLIST.

FOR UK ONLY

Complete details of the boiler, controls, installation and commissioning in the Benchmark checklist at the back of this book. It is important that the Benchmark checklist is correctly completed and handed to the user. Failure to install and commission the appliance to the manufacturers instructions will invalidate the warranty.

5.36 INSTRUCTING THE USER

Hand over all documentation supplied with this appliance – including these instructions – and explain the importance of keeping them in a safe place.

Explain to the user how to isolate the appliance from the gas, water and electricity supplies and the locations of all drain points. Show the user how to operate the appliance and any associated controls correctly.

Show the user the location of the filling valve and how to top-up the system pressure correctly and show the location of all manual air release points.

Explain to the user how to turn off the appliance for both long and short periods and advise on the necessary precautions to prevent frost damage.

Explain to the user that for continued safe and efficient operation, the appliance must be serviced annually by a competent person.

IMPORTANT

To validate the appliance warranty, it's necessary to register the appliance details with us. The warranty can be registered in several ways:

- online at: www.vokera.co.uk (UK) or www.vokera.ie (Ireland)
- UK residents can also register by calling: 0800 479 0751.

5.37 MAINTENANCE

Cleaning the primary heat exchanger

- Isolate the appliance from the gas & electrical supply.
- Remove the casing as explained in paragraph "4.6 CASING REMOVAL".
- Disconnect the connecting cable of the electrode.
- Disconnect the power cables of the fan.
- Take out the clip of the fixing pipe (A) from the mixer.
- Loosen the nut of the gas train (B).
- Rotate and take out the gas pipe from the mixer.
- Remove the 4 nuts (C) that fix the combustion unit.
- Take out the air/gas conveyor assembly including the fan and mixer, being careful not to damage the insulating panel and the electrode.
- Remove the siphon connecting pipe from the condensate drain fitting of the heat exchanger and connect a temporary collecting pipe. At this point proceed with the heat exchanger cleaning operations.
- Vacuum out any dirt residue inside the heat exchanger, being careful NOT to damage the retarder insulating panel.
- Clean the coils of the heat exchanger with a soft bristled brush.

 DO NOT USE METAL BRUSHES THAT COULD DAMAGE THE COMPONENTS.

- Clean the spaces between the coils using a 0.4 mm thick blade (also available in a kit).
- Vacuum away any residue produced by the cleaning.
- Rinse with water, being careful NOT to damage the retarder insulation panel.

 In case of stubborn deposits of combustion products on the surface of the exchanger, clean by spraying natural white vinegar, taking care NOT to damage the retarder insulation panel.

- Leave for a few minutes.
- Clean the coils of the exchanger with a soft bristle brush.

 DO NOT USE METALLIC BRUSHES WHICH CAN DAMAGE THE COMPONENTS.

- Rinse with water, taking care NOT to damage the retarder insulation panel.
- Make sure the retarder insulation panel is undamaged and replace it if necessary following the relative procedure.
- Once the cleaning operations are finished, carefully reassemble all the components, following the above instructions in the reverse order.
- To close the fixing nuts of the air/gas conveyor assembly, use a tightening torque of 6 Nm following the sequence indicated on the diecast (1,2,3,4).
- Restore the gas and electrical supply to the appliance.

Cleaning the burner:

- Isolate the appliance from the gas & electrical supply.
- Remove the casing as explained in paragraph "4.6 CASING REMOVAL".
- Disconnect the connecting cable of the electrode.
- Disconnect the power cables of the fan.
- Take out the clip of the fixing pipe (A) from the mixer.
- Loosen the nut of the gas train (B).
- Rotate and take out the gas pipe from the mixer.
- Remove the 4 nuts (C) that fix the combustion unit.
- Take out the air/gas conveyor assembly including the fan and mixer, being careful not to damage the ceramic insulation panel and the electrode. At this point proceed with the burner cleaning operations.
- Clean the burner with a soft bristled brush, being careful not to damage the insulation panel and the electrode.

 DO NOT USE METAL BRUSHES THAT COULD DAMAGE THE COMPONENTS.

- Check that the burner insulating panel and the sealing gasket are undamaged and replace them if necessary, following the relative procedure.
- Once the cleaning operations are finished, carefully reassemble all the components, following the above instructions in the reverse order.
- To close the fixing nuts of the air/gas conveyor assembly, use a tightening torque of 6 Nm.
- Restore the gas and electrical supply to the appliance.

Replacing the burner insulating panel

- Unscrew the ignition/detection electrode fixing screws and remove it.
- Remove the burner insulating panel (D) by inserting a blade underneath the surface (as shown in the figure).
- Remove any fixing glue residue.
- Replace the insulating panel.
- The new insulating panel does not need to be fixed in place with glue as its geometry ensures perfect coupling with the heat exchanger flange.
- Reassemble the ignition/detection electrode using the previously removed screws and replacing the relative seal.

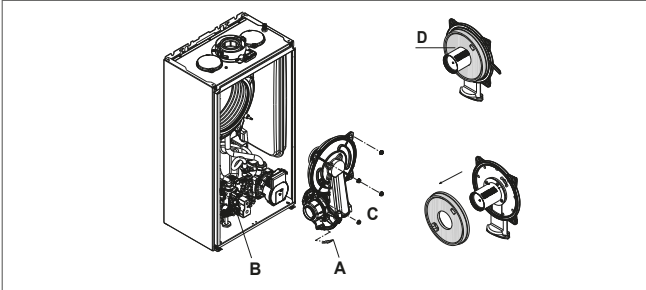

Cleaning the siphon

- Disconnect the tubes (A) and (B), remove the clip (C) and remove the siphon.
- Unscrew the bottom and the top caps, then remove the float.
- Clean the parts of the siphon from any solid residues.

⚠ Do not remove the float and its sealing gasket as their presence is intended to prevent the escape of burnt gases into the environment in the event of no condensation.

⚠ Once the operations have been completed, reassemble the components by operating in the reverse order to what is described, checking the floating seal and replace it if necessary. If replacing the float gasket, make sure it is correctly positioned in its seat (see figure in section).

⚠ At the end of the cleaning sequence, fill the siphon with water (see "5.7 FIRST COMMISSIONING") before restarting the boiler.

⚠ At the end of the siphon maintenance operations, it is recommended to bring the boiler to condensing mode for a few minutes and to check for leaks from the entire condensate evacuation line.

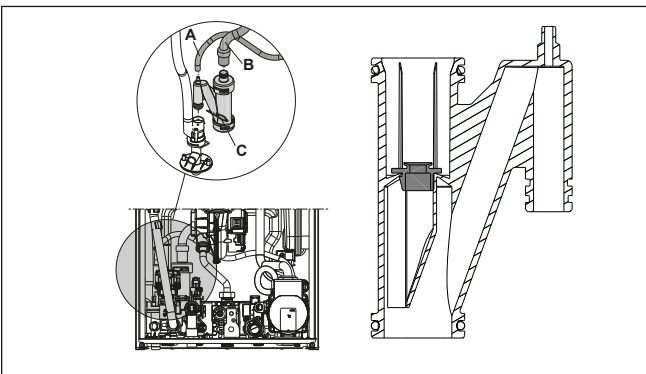

6 SECTION - SERVICING INSTRUCTIONS

GENERAL

Once the appliance has been serviced, the benchmark Service Record must be completed.

For UK only

It is important that the Benchmark Service Record is correctly completed and handed to the user. Failure to install and commission the appliance to the manufacturers instructions will invalidate the warranty.

To ensure the continued safe and efficient operation of the appliance, it is recommended that it is checked and serviced at regular intervals. To ensure correct and safe operation of the appliance, it is essential that any worn or failed component be replaced only with a **genuine Vokera spare part**. It should be remembered that although certain generic components may look similar, they will be specific to an individual appliance or product range. Use of non-genuine Vokera spare parts could invalidate your warranty and may pose a potential safety hazard. The frequency of servicing will depend upon the particular installation conditions, but in general, once per year should be sufficient. It is the law that any servicing work is carried out by competent person such as a Vokera engineer, an approved service agent, British Gas, GAS SAFE registered personnel or other suitably qualified personnel. The following instructions apply to the appliance and its controls, but it should be remembered that the central heating and the domestic hot water systems would also require attention from time to time.

ROUTINE ANNUAL MAINTENANCE

The appliance incorporates many 'state-of-the-art' components that are either 'solid-state' or are regarded as 'non-serviceable' items. As a consequence, the requirements for routine annual maintenance are focussed upon:

1. ensuring that the appliance and flue system are in a safe condition
2. ensuring that the appliance is operating safely
3. ensuring that the appliance is performing to its design specification.

When the appliance has been installed to within the minimum stated clearances; the appliance layout is such that it enables routine annual maintenance to be carried out entirely from the front of the appliance.

NOTE

Any noticeable defect or deterioration on or within the appliance and flue system that impacts or affects the above requirements; will warrant further diagnosis and repair, which may result in the replacement of components.

Specific advice and instruction on the removal and replacement of component parts of the appliance can be found online using the adjacent QR code or by visiting our website.

ROUTINE ANNUAL MAINTENANCE REQUIREMENTS

1. Check the operation of the appliance in both the heating and hot water modes and ensure the performance is in line with the appliance specification.
2. Using the UI menu, navigate to the alarms history and check for any recent alarm events (see "5.28 Alarm history"). Refer to the alarm/fault codes description chart for further information (see "5.25 Faults and reporting").
3. Remove the front cover (see "4.6 CASING REMOVAL") and visually inspect the internal components and electrical wiring for any defect or deterioration.
4. Visually check for any dirt or debris within the condensate trap (the trap is translucent and can be checked visually).
5. Replace the front cover as detailed in section "4.6 CASING REMOVAL" taking notice of the importance of ensuring that the effectiveness of the – front cover – seals are not compromised.
6. Carry out a combustion analysis as detailed in "5.34 INFO menu".
7. Visually check the entire flue system for any damage, defect, or deterioration.

NOTE

In order to access the 'alarms history' it is necessary to access the password protected settings. Refer to "5.9 Setting password, access and parameter modification" for further details.

UNSCHEDULED MAINTENANCE

The appliance incorporates software that monitors the operating conditions of the appliance, and will record any 'unusual usage conditions' that will affect the requirement to remove and clean the burner/heat exchanger assembly. When the 'unusual usage' hours reach a pre-determined threshold, the appliance will signal – via alarm code E091 – that the heat exchanger requires to be cleaned.

REPLACEMENT OF COMPONENTS

Although it is anticipated that this appliance will provide years of trouble-free service and outstanding performance; the lifespan of any component will be determined by factors such as operating conditions and usage levels. Should the appliance develop a fault, the fault-finding section of this manual will greatly assist in determining the cause; however further advice can be sought from the Vokera Technical Help-line. Remember always to use only genuine Vokera spare parts.

COMPONENT REMOVAL PROCEDURE

To remove/replace a component, access to the interior of the appliance is usually essential.

Always isolate the appliance from the electrical supply – and if necessary remove the fuse.

- Close all service valves if any hydraulic and/or gas carrying item is to be removed.
- Remove the front cover – and where possible or convenient – the side panels of the appliance as detailed in "4.6 CASING REMOVAL".
- If required, drain the primary circuit via the drain valve (located adjacent to the diverter valve) using the tubing supplied with the appliance.
- If required, drain the secondary circuit via the available DHW outlets.

NOTE

When removing a hydraulic component, ensure that some water absorbent cloths are available to catch any residual water that may drip from the appliance and/or the removed component.

When the appliance has been installed to within the stated minimum clearances; it may be necessary to remove adjacent components in order to facilitate access to a specific component.

Carry out the relevant elements of the commissioning procedure after replacing a component.

ALWAYS TEST FOR GAS TIGHTNESS IF ANY GAS CARRYING COMPONENT HAS BEEN DISTURBED, REMOVED, OR REPLACED.

WHEN REPLACING THE SIDE PANELS AND/OR THE FRONT COVER, ENSURE THE ROOM SEALED INTEGRITY OF THE APPLIANCE HAS NOT BEEN COMPROMISED – REFER TO "4.6 CASING REMOVAL".

To obtain detailed specific information and instructions on how to remove and replace specific components, please access our online resources using the below QR code or by logging on to our website.

www.vokera.co.uk

www.vokera.ie

7 WIRING DIAGRAMS

NOTE

Please refer to 3 - 3E and use the appropriate PPE when carrying out any of the actions or procedures contained within this section.

7.1 INTERNAL RTC BLUETOOTH CLOCK MODULE

The appliance is supplied with a Bluetooth module (BLE) that enables the heating ON/OFF time schedules to be managed via the Easi-Connect app (available as a download from the App Store or Google Play – see below QR code); in addition there is a switch (SW) that allows the RTC clock to be bypassed thereby enabling a heating request to be generated. **NOTE:** enabling the auxiliary switch (SW) will allow the boiler to run in heating mode continuously until the switch is disabled.

If external controls are to be added to the system, they must be connected to the appliance as follows:

- Voltage-free room thermostat with RTC clock activated: remove the black link-wire from terminal block M4 and connect the two wires (C & NO) from the room thermostat (see also 7.3).
- Voltage-free programmable room thermostat, RTC clock deactivated: remove the black link-wire from terminal block M4 and connect the two wires (C & NO) from the programmable room thermostat; and enable the auxiliary switch (SW).
- BeSMART or Hi-Comfort Opentherm device: refer to fig. 17.
- Modbus 485 (Smart-Key): remove the plug from socket CE4 located on the appliance underside (fig. 18) and insert the Smart-Key into the socket and follow the instructions provided with the Smart-Key.
- Modbus 485 (other device): contact Vokèra Technical Helpline for detailed advice.

NOTE

- Refer to the adjacent diagrams for further details.
- Should your external control require a 230V power supply, it must be taken from the same isolator that supplies power to the boiler.
- Ensure the necessary parameter/s for external sensor/Opentherm/Modbus 485 have been set correctly if one or more of these devices has been installed – see pages 30 & 31, Sections 5.32 & 5.33.
- For advice on controls that are not featured here, please contact Vokèra technical on 0844 391 0999.

7.1.1 EXTERNAL WIRING LIMITATIONS

Low voltage and High voltage cables must be run separately. Any external wiring must remain within the limits as detailed: room thermostat = 30-metres maximum.

7.1.2 OUTSIDE SENSOR

The outside sensor can be connected directly on the PCB at plug X11 (see “Fig. 16”).

7.2 OTHER DEVICES

Contact the controls manufacturer and/or Vokèra technical department should you require more specific information on the suitability of a particular control.

IMPORTANT

- The boiler must always be supplied with a permanent 230V electrical supply.
- The room thermostat connection (TA) is low voltage (24 Vdc)
- Do not connect any controls or auxiliary equipment to the low-voltage terminal strip, other than that approved/supplied by Vokèra Ltd.

7.3 RTC BLEUTOOTH CLOCK MODULE

- The RTC module must be configured and activated using a compatible smart phone or tablet, via the Easi-Connect app (see page xx and below QR code for further details).
- Once the RTC module has been paired and configured with the Easi-Connect app, the app will run in the background in the mode of operation last used/activated
- To change the mode of operation, or amend the heating schedule/program, it's necessary to be within 3-metres of the appliance, using the relevant smart device that's been paired with the RTC module.

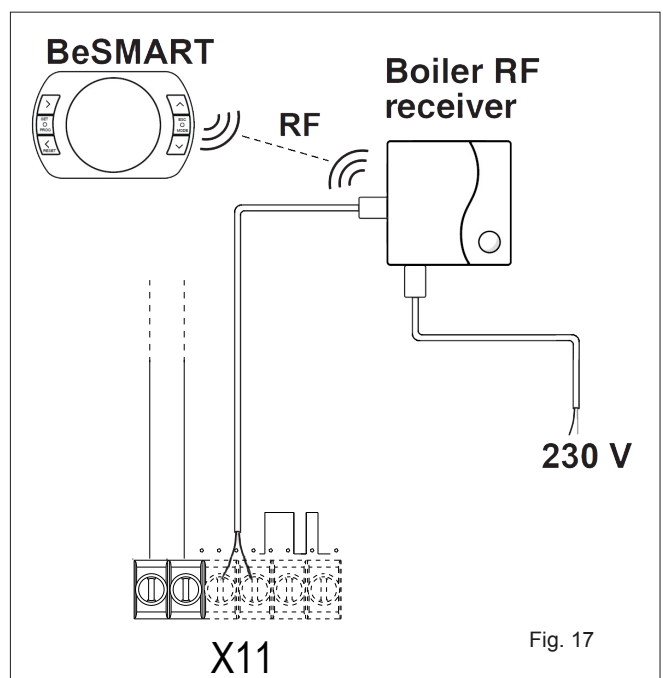
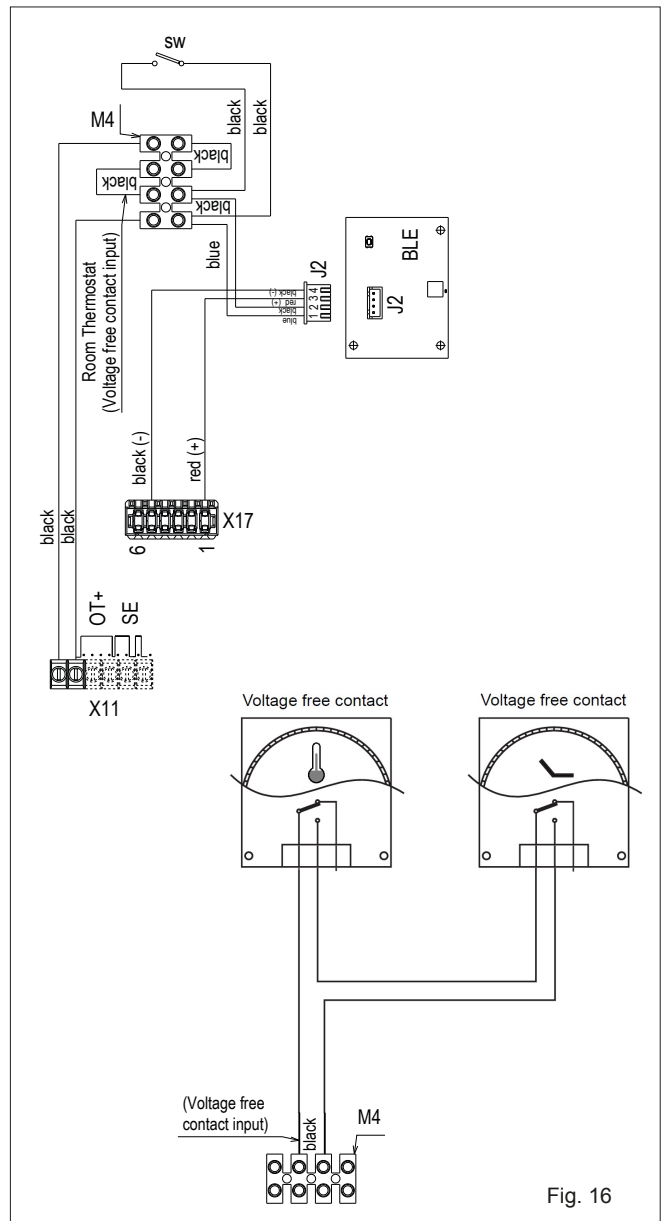

7.4 INTEGRAL BLUETOOTH TIMER (EASI-CONNECT)

Your appliance incorporates a Bluetooth time clock that can be used -via our Easi-Connect app – to control the heating ON/OFF time periods. **NOTE:** Please check with your installer and ask whether the Bluetooth clock is active or has been disabled, before proceeding with the setup of the 'Easi-Connect' app.

Download the Easi-Connect app

The Easi-Connect app can be downloaded from the Apple app store (for iOS devices), or Google Play (for Android devices). The Easi-Connect app will work with iOS version xx or later, or Android version xx or later.

Configure the Easi-Connect app

The Easi-Connect app is extremely intuitive and easy to set up; however a setup guide can be accessed here if necessary:

INSERT QR CODE HERE

- Ensure that you're smart device (phone, tablet, etc.) is within 3-metres of your appliance and that the appliance is switched ON
- Ensure that your smart device has Bluetooth enabled and is in pairing mode
- Open the Easi-Connect app and follow the on screen instructions that will guide you through the search and connect process
- When Easi-Connect has succeeded in connecting to your appliance, press the 'Discover' button to enter the mode screen

Modes of Operation

- My Program: allows you to program multiple ON/OFF schedules according to your routines; each schedule can be edited, modified, or deleted, at any time.
- Default Program: the default program (see schedule below) is the built-in ON/OFF heating schedules, the default program cannot be edited, modified, or deleted.
- Always ON: the heating will be ON continuously (this is useful if you want to have the heating ON out-with the heating schedule).
- Always OFF: the heating will be OFF continuously (this is useful if you want to have the heating OFF out-with the heating schedule).

Default Program

INSERT DEFAULT SCHEDULE HERE

My Program

The 'My Program' mode, allows you to add multiple ON/OFF heating schedules for single days, groups of days, or all 7-days according to your requirements. Each ON or OFF period is active for a minimum of 30-minutes.

To add or edit the heating schedule, proceed as follows:

1. From the Easi-Connect home screen, press the 'My Program' button.
2. Choose the schedule that you wish to edit or modify, or alternatively press the 'add schedule' button.
3. Select which days you wish to be included in the schedule.
4. Select the Start time and the End time that you wish the heating schedule to be active.
5. Press the 'save schedule' button and wait 10-seconds before returning to the home screen.
6. Select and/or enable 'My Program' as desired.

FUNCTIONAL DIAGRAM

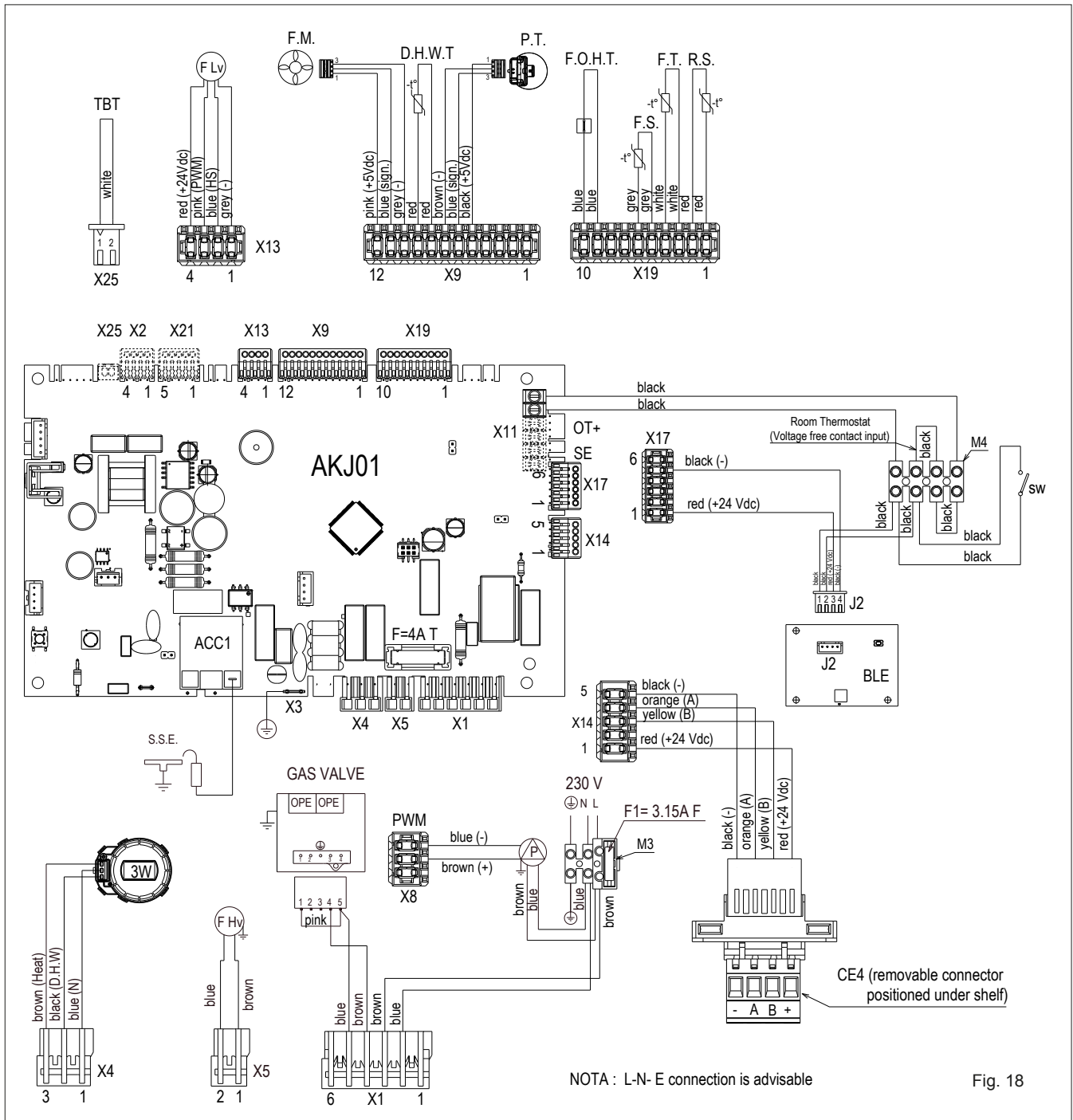

- AKJ01... Main PCB
- BLE Board clock
- X1-X25 Connectors (X2 – X11 – X21 – X25 accessories)
- ACC1 Ignition transformer
- S.E.E. Spark/sense electrode
- F Fuse 4A T
- TBT Underfloor heating thermostat
- F Lv Fan signal control
- F.M. Flow meter
- D.H.W.T Domestic hot water temperature
- P.T. Pressure transducer
- F.O.H.T. Flow over heat thermostat
- FS Flue sensor
- FT Flow thermistor
- RS Return thermistor
- 3W 3 way valve motor
- F Hv Fan power supply 230 V
- OPE Gas valve solenoids
- PWM PWM signal
- P Pump
- M3 Terminal strip for electrical connection high power
- M4 Terminal strip for room thermostat
- SW Switch
- CE4 External link connector: (- A B +) Bus 485

To connect the:
 T.B.T. = underfloor heating thermostat it is necessary to cut in half the white jumper marked with the word TBT present in the 2-pole connector (X25), strip the wires and use an electric terminal for the junction.

FUNCTIONAL DIAGRAM - ACCESSORIES

	X11	TA: (room thermostat)
	X11	OT+ (Open Therm)
	X11	SE: (external sensor)
	X2	Alarm remote control
	X21	Zone valve or additional pump
	X25	TBT: Underfloor heating thermostat

8 LPG INSTRUCTIONS

8.1 RELATED DOCUMENTS

BS 6798		INSTALLATION OF BOILERS OF RATED INPUT NOT EXCEEDING 60 kW
BS EN 12828		DESIGN FOR WATER-BASED HEATING SYSTEMS
BS 5446		INSTALLATION OF GAS HOT WATER SUPPLIES FOR DOMESTIC PURPOSES
BS 5440	PARTS 1 & 2	FLUES & VENTILATION
BS 6891		SPECIFICATION FOR THE INSTALLATION AND MAINTENANCE OF LOW PRESSURE GAS INSTALLATION PIPEWORK OF UP TO 35 mm

8.2 TECHNICAL DATA

Gas Pressures	VIBE MAX 26C	VIBE MAX 30C
Inlet pressure	37.0 mbar	37.0 mbar
Heating maximum gas rate (kg/hr)	1.55	1.94
DHW maximum gas rate (kg/hr)	1.94	2.33
Minimum gas rate (kg/hr)	0.39	0.39
Injector size	3.6 mm	3.8 mm
CO ₂ @ maximum output (%)	10.0	10.0
CO ₂ @ minimum output (%)	10.0	10.0
CO @ maximum output (ppm)	140	150
CO @ minimum output (ppm)	30	20
Slow ignition (rpm)	5.500	5.500
CH maximum number of fan rotation (rpm)	6.900	6.800
DHW maximum number of fan rotation (rpm)	8.500	7.900
Minimum number of fan rotation (rpm)	2.050	1.700

NOTE

Please refer to 3 - 3E and use the appropriate PPE when carrying out any of the actions or procedures contained within this section.

8.3 GAS CONVERSION

Conversion from the gas of one family to the gas of another family can be done easily even when the boiler is already installed.

This operation must be carried out by professionally qualified personnel. The boiler is designed to operate with methane gas (G20) or LPG (G31) according to the product label. The boiler can be transformed to LPG or to methane gas (G20) by means of special kits.

For disassembly refer to instructions below:

- disconnect the boiler from the electricity supply and turn off the gas tap
- remove the casing as explained in paragraph "4.6 CASING REMOVAL"
- release the instrument panel and rotate it forwards
- unscrew the pipe nut from the gas valve and rotate the pipe so as to have access to the gas nozzle (**B**) in the outlet fitting
- remove the nozzle (**B**) and replace it with the one from the kit
- put the pipe of the gas valve back in place and screw the nut
- reposition the previously removed components
- power up the boiler and open the gas tap again.

Adjust the boiler as explained in paragraphs "5.22 Adjustments" and "5.23 Gas valve calibration".



Conversion must be carried out by qualified personnel.



After the transformation, apply the new gas rating plate included in the kit.



After each intervention on the adjustment element of the gas valve, seal it with sealing varnish.

8.4 COMPLETION

On completion of the combustion analysis check and/or any gas valve adjustment, see paragraph "5.21 Combustion analysis"). Remove the test probe from the test point and refit the sealing screw/s and/or cap.

IMPORTANT

A GAS TIGHTNESS CHECK MUST BE CARRIED OUT IF ANY GAS CARRYING COMPONENTS HAVE BEEN REMOVED, REPLACED OR DISTURBED.

ATTENTION

Gas type and appliance output **must be set** according to the specific appliance specification. Vokèra accepts no responsibility if the gas type is not correctly adjusted according to the respective appliance specification as detailed on the appliance data badge.

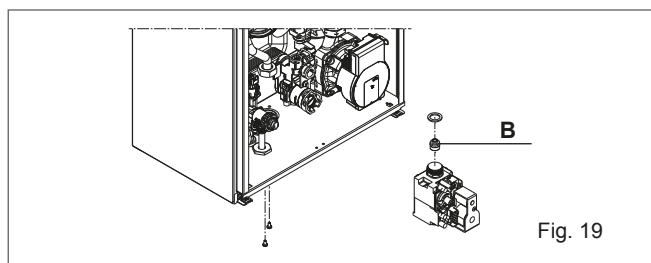

Fig. 19

COMMISSIONING: CO AND COMBUSTION RATIO CHECK

BEFORE CO AND COMBUSTION RATIO CHECK

The installation instructions should have been followed, gas type verified and gas supply pressure/rate checked as required prior to commissioning.

As part of the installation process, **ESPECIALLY WHERE A FLUE HAS BEEN FITTED BY PERSONS OTHER THAN THE BOILER INSTALLER**, visually check the integrity of the whole flue system to confirm that all components are correctly assembled, fixed and supported. Check that the maximum flue lengths have not been exceeded and all guidance has been followed (e.g. Technical Bulletin 008).

The flue gas analyser should be of the correct type, as specified by BS 7967.

Before use, the flue gas analyser should have been maintained and calibrated as specified by the manufacturer. The installer must have the relevant competence for use of the analyser.

Check and zero the analyser **IN FRESH AIR**, as per analyser manufacturer's instructions.

NOTE

The air/gas ratio valve is factory-set and must not be adjusted during commissioning unless this action is recommended, following contact with the Vokera technical help line. If any such adjustment is recommended and further checking of the boiler is required, the engineer must be competent to carry out this work and to use the flue gas analyser accordingly. If the boiler requires conversion to operate with a different gas family (e.g., conversion from natural gas to LPG) separate guidance will be provided by the Vokera technical help line and must be followed.

SET BOILER TO MAXIMUM RATE

In accordance with, section 7.3, set boiler to operate at maximum rate (full load condition). Allow sufficient time for combustion to stabilise. , insert analyser probe into air inlet sampling point.

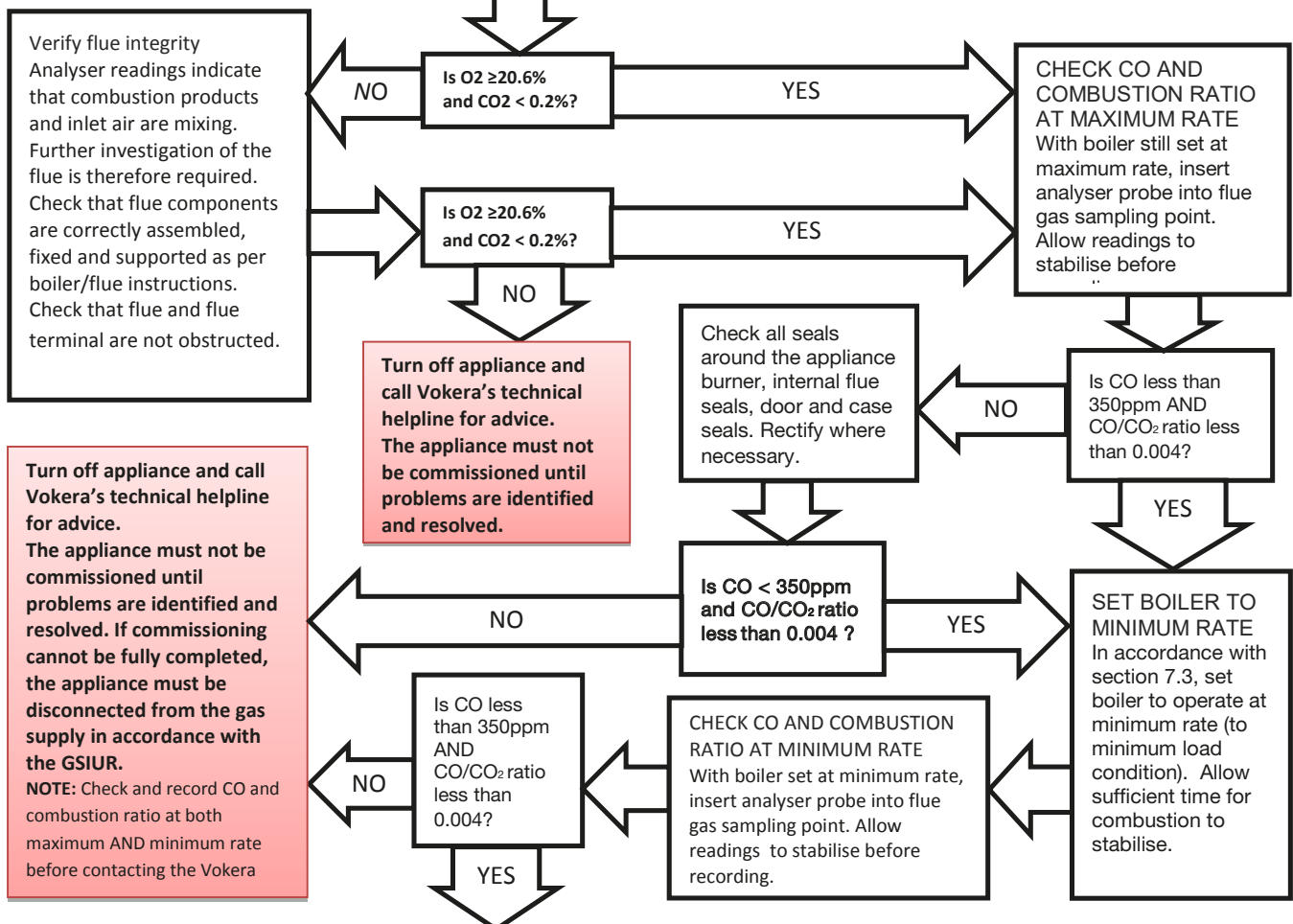

Boiler is operating satisfactorily No further actions required.

Ensure test points are capped, boiler case is correctly replaced and all other commissioning procedures are completed. Complete Benchmark Checklist, recording CO and combustion ratio readings as required.

Benchmark Commissioning & Warranty Validation Service Record

It is a requirement that the boiler is installed and commissioned to the manufacturers' instructions and the data fields on the commissioning checklist completed in full.

To instigate the boiler warranty the boiler needs to be registered with the manufacturer within one month of the installation. The warranty rests with the end-user (consumer), and they should be made aware it is ultimately their responsibility to register with the manufacturer, within the allotted time period.

It is essential that the boiler is serviced in line with the manufacturers' recommendations, at least annually. This must be carried out by a competent Gas Safe registered engineer. The service details should be recorded on the Benchmark Service and Interim Boiler Work Record and left with the householder. Failure to comply with the manufacturers' servicing instructions and requirements will invalidate the warranty.



www.hhic.co.uk

This Commissioning Checklist is to be completed in full by the competent person who commissioned the boiler as a means of demonstrating compliance with the appropriate Building Regulations and then handed to the customer to keep for future reference.

Failure to install and commission according to the manufacturers' instructions and complete this Benchmark Commissioning Checklist will invalidate the warranty. This does not affect the customer's statutory rights.

All installations in England and Wales must be notified to Local Authority Building Control (LABC) either directly or through a competent Persons Scheme. A Building Regulations Compliance Certificate will then be issued to the customer.

Heating and Hotwater Industry Council (HHIC)



www.centralheating.co.uk

GAS BOILER SYSTEM COMMISSIONING CHECKLIST & WARRANTY VALIDATION RECORD

Address:											
Boiler make and model:											
Boiler serial number:											
Commissioned by (PRINT NAME):						Gas Safe registration number:					
Company name:						Telephone number:					
Company email:						Company address:					
										Commissioning date:	
Heating and hot water system complies with the appropriate Building Regulations?											Yes
Optional: Building Regulations Notification Number (if applicable):											
Time, temperature control and boiler interlock provided for central heating and hot water											Yes
Boiler Plus requirements (tick the appropriate box(s))											
Boiler Plus option chosen for combination boiler in ENGLAND						Weather compensation		Smart thermostat with automation and optimisation			
						Load compensation		Flue Gas Heat Recovery			
Time and temperature control to hot water			Cylinder thermostat and programmer/timer				Combination boiler				
Zone valves		pre-existing		Fitted		Not required					
Thermostatic radiator valves		pre-existing		Fitted		Not required					
Automatic bypass to system		pre-existing		Fitted		Not required					
Underfloor heating		pre-existing		Fitted		Not required					
Water quality											
The system has been flushed, cleaned and a suitable inhibitor applied upon final fill, in accordance with BS7593 and boiler manufacturers' instructions											Yes
What system cleaner was used?						Brand:			Product:		
What inhibitor was used?						Brand:			Product:		
Primary water system filter		pre-existing		Fitted		Not required					
CENTRAL HEATING MODE measure and record (as appropriate)											
Gas rate (for combination boilers complete DHW mode gas rate)						m ³ /hr		or		ft ³ /hr	
Central heating output left at factory settings?						Yes				No	
If no, what is the maximum central heating output selected?						kW					
Dynamic gas inlet pressure						mbar					
Central heating flow temperature						°C					
Central heating return temperature						°C					
System correctly balanced/rebalanced?						Yes					
COMBINATION BOILERS ONLY											
Is the installation in a hard water area (above 200ppm)?						Yes				No	
Water scale reducer/softener		pre-existing		Fitted		Not required					
What type of scale reducer/softener has been fitted?						Brand:			Product:		
Water meter fitted?						Yes				No	
If yes- DHW expansion vessel		pre-existing		Fitted		Not required					
Pressure reducing valve		pre-existing		Fitted		Not required					
DOMESTIC HOT WATER MODE Measure and record											
Gas rate						m ³ /hr		or		ft ³ /hr	
Dynamic gas inlet pressure at maximum rate						mbar					
Cold water inlet temperature						°C					
Hot water has been checked at all outlets						Yes		Temperature		°C	
CONDENSATE DISPOSAL											
The condensate drain has been installed in accordance with the manufacturers' instructions and/or BS5546/BS6798											Yes
Point of termination						Internal				External (only where internal termination impractical)	
Method of disposal						Gravity				Pumped	
ALL INSTALLATIONS											
Record the following		At max rate:		CO ppm		CO ₂ %		CO/CO ₂		Ratio	
		At min rate (where possible)		CO ppm		CO ₂ %		CO/CO ₂		Ratio	
Where possible, has a flue integrity check been undertaken in accordance with manufacturers' instructions, and readings are correct?											Yes
The operation of the boiler and system controls have been demonstrated to and understood by the customer											Yes
The manufacturers' literature, including Benchmark Checklist and Service Record, has been explained and left with the customer											Yes
Commissioning Engineer's signature											
Customer's signature (To confirm satisfactory demonstration and receipt of manufacturers' literature)											

* All installations in England and Wales must be notified to Local Authority Building Control (LABC) either directly or through a Competent Persons Scheme. A Building Regulations Compliance Certificate will then be issued to the customer.

© Heating and Hotwater Industry Council (HHIC)



www.centralheating.co.uk

SERVICE & INTERIM BOILER WORK RECORD

It is recommended that your boiler and heating system are regularly serviced and maintained, in line with manufacturers' instructions, and that the appropriate service / interim work record is completed.

Service provider

When completing a service record (as below), please ensure you have carried out the service as described in the manufacturers' instructions. Always use the manufacturers specified spare parts.

SERVICE/INTERIM WORK ON BOILER <small>delete as appropriate</small>				Date:	
Engineer name:		Company name:			
Telephone N°:		Gas Safe registration N°:			
Max rate	CO	ppm	CO ₂	% CO/CO ₂	
Min rate	CO	ppm	CO ₂	% CO/CO ₂	
Where possible, has a flue integrity check been undertaken in accordance with manufacturers' instructions, and readings are correct?*				yes	
Gas rate:	m ³ /h	OR	ft ³ /h		
Were parts fitted? <small>delete as appropriate</small>		Yes	No		
Parts fitted:					
System inhibitor concentration has been checked and appropriate action taken, in accordance with BS 7593 and boiler manufacturers' instructions. *				yes	n/a
Comments:					
Signature:					

*A System inhibitor efficacy test is required on every annual service in accordance with the manufacturers' instructions and BS 7593. It is only acceptable to not have undertaken this if the service engineers attendance visit was in between annual services to attend a non-water facing component.

SERVICE/INTERIM WORK ON BOILER <small>delete as appropriate</small>				Date:	
Engineer name:		Company name:			
Telephone N°:		Gas Safe registration N°:			
Max rate	CO	ppm	CO ₂	% CO/CO ₂	
Min rate	CO	ppm	CO ₂	% CO/CO ₂	
Where possible, has a flue integrity check been undertaken in accordance with manufacturers' instructions, and readings are correct?*				yes	
Gas rate:	m ³ /h	OR	ft ³ /h		
Were parts fitted? <small>delete as appropriate</small>		Yes	No		
Parts fitted:					
System inhibitor concentration has been checked and appropriate action taken, in accordance with BS 7593 and boiler manufacturers' instructions. *				yes	n/a
Comments:					
Signature:					

*A System inhibitor efficacy test is required on every annual service in accordance with the manufacturers' instructions and BS 7593. It is only acceptable to not have undertaken this if the service engineers attendance visit was in between annual services to attend a non-water facing component.

SERVICE/INTERIM WORK ON BOILER <small>delete as appropriate</small>				Date:	
Engineer name:		Company name:			
Telephone N°:		Gas Safe registration N°:			
Max rate	CO	ppm	CO ₂	% CO/CO ₂	
Min rate	CO	ppm	CO ₂	% CO/CO ₂	
Where possible, has a flue integrity check been undertaken in accordance with manufacturers' instructions, and readings are correct?*				yes	
Gas rate:	m ³ /h	OR	ft ³ /h		
Were parts fitted? <small>delete as appropriate</small>		Yes	No		
Parts fitted:					
System inhibitor concentration has been checked and appropriate action taken, in accordance with BS 7593 and boiler manufacturers' instructions. *				yes	n/a
Comments:					
Signature:					

*A System inhibitor efficacy test is required on every annual service in accordance with the manufacturers' instructions and BS 7593. It is only acceptable to not have undertaken this if the service engineers attendance visit was in between annual services to attend a non-water facing component.

SERVICE/INTERIM WORK ON BOILER <small>delete as appropriate</small>				Date:	
Engineer name:		Company name:			
Telephone N°:		Gas Safe registration N°:			
Max rate	CO	ppm	CO ₂	% CO/CO ₂	
Min rate	CO	ppm	CO ₂	% CO/CO ₂	
Where possible, has a flue integrity check been undertaken in accordance with manufacturers' instructions, and readings are correct?*				yes	
Gas rate:	m ³ /h	OR	ft ³ /h		
Were parts fitted? <small>delete as appropriate</small>		Yes	No		
Parts fitted:					
System inhibitor concentration has been checked and appropriate action taken, in accordance with BS 7593 and boiler manufacturers' instructions. *				yes	n/a
Comments:					
Signature:					

*A System inhibitor efficacy test is required on every annual service in accordance with the manufacturers' instructions and BS 7593. It is only acceptable to not have undertaken this if the service engineers attendance visit was in between annual services to attend a non-water facing component.

SERVICE/INTERIM WORK ON BOILER <small>delete as appropriate</small>				Date:	
Engineer name:		Company name:			
Telephone N°:		Gas Safe registration N°:			
Max rate	CO	ppm	CO ₂	% CO/CO ₂	
Min rate	CO	ppm	CO ₂	% CO/CO ₂	
Where possible, has a flue integrity check been undertaken in accordance with manufacturers' instructions, and readings are correct?*				yes	
Gas rate:	m ³ /h	OR	ft ³ /h		
Were parts fitted? <small>delete as appropriate</small>		Yes	No		
Parts fitted:					
System inhibitor concentration has been checked and appropriate action taken, in accordance with BS 7593 and boiler manufacturers' instructions. *				yes	n/a
Comments:					
Signature:					

*A System inhibitor efficacy test is required on every annual service in accordance with the manufacturers' instructions and BS 7593. It is only acceptable to not have undertaken this if the service engineers attendance visit was in between annual services to attend a non-water facing component.

SERVICE/INTERIM WORK ON BOILER <small>delete as appropriate</small>				Date:	
Engineer name:		Company name:			
Telephone N°:		Gas Safe registration N°:			
Max rate	CO	ppm	CO ₂	% CO/CO ₂	
Min rate	CO	ppm	CO ₂	% CO/CO ₂	
Where possible, has a flue integrity check been undertaken in accordance with manufacturers' instructions, and readings are correct?*				yes	
Gas rate:	m ³ /h	OR	ft ³ /h		
Were parts fitted? <small>delete as appropriate</small>		Yes	No		
Parts fitted:					
System inhibitor concentration has been checked and appropriate action taken, in accordance with BS 7593 and boiler manufacturers' instructions. *				yes	n/a
Comments:					
Signature:					

*A System inhibitor efficacy test is required on every annual service in accordance with the manufacturers' instructions and BS 7593. It is only acceptable to not have undertaken this if the service engineers attendance visit was in between annual services to attend a non-water facing component.

* All installations in England and Wales must be notified to Local Authority Building Control (LABC) either directly or through a Competent Persons Scheme. A Building Regulations Compliance Certificate will then be issued to the customer.

© Heating and Hotwater Industry Council (HHIC)



www.centralheating.co.uk

SERVICE & INTERIM BOILER WORK RECORD

It is recommended that your boiler and heating system are regularly serviced and maintained, in line with manufacturers' instructions, and that the appropriate service / interim work record is completed.

Service provider

When completing a service record (as below), please ensure you have carried out the service as described in the manufacturers' instructions. Always use the manufacturers' specified spare parts.

SERVICE/INTERIM WORK ON BOILER <small>delete as appropriate</small>					Date:	
Engineer name:		Company name:				
Telephone N°:		Gas Safe registration N°:				
Max rate	CO	ppm	CO ₂	%	CO/CO ₂	
Min rate	CO	ppm	CO ₂	%	CO/CO ₂	
Where possible, has a flue integrity check been undertaken in accordance with manufacturers' instructions, and readings are correct?"					yes	
Gas rate:	m ³ /h	OR	ft ³ /h			
Were parts fitted? <small>delete as appropriate</small>		Yes	No			
Parts fitted:						
System inhibitor concentration has been checked and appropriate action taken, in accordance with BS 7593 and boiler manufacturers' instructions. *					yes	n/a
Comments:						
Signature:						

*A System inhibitor efficacy test is required on every annual service in accordance with the manufacturers' instructions and BS 7593. It is only acceptable to not have undertaken this if the service engineers attendance visit was in between annual services to attend a non-water facing component.

SERVICE/INTERIM WORK ON BOILER <small>delete as appropriate</small>					Date:	
Engineer name:		Company name:				
Telephone N°:		Gas Safe registration N°:				
Max rate	CO	ppm	CO ₂	%	CO/CO ₂	
Min rate	CO	ppm	CO ₂	%	CO/CO ₂	
Where possible, has a flue integrity check been undertaken in accordance with manufacturers' instructions, and readings are correct?"					yes	
Gas rate:	m ³ /h	OR	ft ³ /h			
Were parts fitted? <small>delete as appropriate</small>		Yes	No			
Parts fitted:						
System inhibitor concentration has been checked and appropriate action taken, in accordance with BS 7593 and boiler manufacturers' instructions. *					yes	n/a
Comments:						
Signature:						

*A System inhibitor efficacy test is required on every annual service in accordance with the manufacturers' instructions and BS 7593. It is only acceptable to not have undertaken this if the service engineers attendance visit was in between annual services to attend a non-water facing component.

SERVICE/INTERIM WORK ON BOILER <small>delete as appropriate</small>					Date:	
Engineer name:		Company name:				
Telephone N°:		Gas Safe registration N°:				
Max rate	CO	ppm	CO ₂	%	CO/CO ₂	
Min rate	CO	ppm	CO ₂	%	CO/CO ₂	
Where possible, has a flue integrity check been undertaken in accordance with manufacturers' instructions, and readings are correct?"					yes	
Gas rate:	m ³ /h	OR	ft ³ /h			
Were parts fitted? <small>delete as appropriate</small>		Yes	No			
Parts fitted:						
System inhibitor concentration has been checked and appropriate action taken, in accordance with BS 7593 and boiler manufacturers' instructions. *					yes	n/a
Comments:						
Signature:						

*A System inhibitor efficacy test is required on every annual service in accordance with the manufacturers' instructions and BS 7593. It is only acceptable to not have undertaken this if the service engineers attendance visit was in between annual services to attend a non-water facing component.

SERVICE/INTERIM WORK ON BOILER <small>delete as appropriate</small>					Date:	
Engineer name:		Company name:				
Telephone N°:		Gas Safe registration N°:				
Max rate	CO	ppm	CO ₂	%	CO/CO ₂	
Min rate	CO	ppm	CO ₂	%	CO/CO ₂	
Where possible, has a flue integrity check been undertaken in accordance with manufacturers' instructions, and readings are correct?"					yes	
Gas rate:	m ³ /h	OR	ft ³ /h			
Were parts fitted? <small>delete as appropriate</small>		Yes	No			
Parts fitted:						
System inhibitor concentration has been checked and appropriate action taken, in accordance with BS 7593 and boiler manufacturers' instructions. *					yes	n/a
Comments:						
Signature:						

*A System inhibitor efficacy test is required on every annual service in accordance with the manufacturers' instructions and BS 7593. It is only acceptable to not have undertaken this if the service engineers attendance visit was in between annual services to attend a non-water facing component.

SERVICE/INTERIM WORK ON BOILER <small>delete as appropriate</small>					Date:	
Engineer name:		Company name:				
Telephone N°:		Gas Safe registration N°:				
Max rate	CO	ppm	CO ₂	%	CO/CO ₂	
Min rate	CO	ppm	CO ₂	%	CO/CO ₂	
Where possible, has a flue integrity check been undertaken in accordance with manufacturers' instructions, and readings are correct?"					yes	
Gas rate:	m ³ /h	OR	ft ³ /h			
Were parts fitted? <small>delete as appropriate</small>		Yes	No			
Parts fitted:						
System inhibitor concentration has been checked and appropriate action taken, in accordance with BS 7593 and boiler manufacturers' instructions. *					yes	n/a
Comments:						
Signature:						

*A System inhibitor efficacy test is required on every annual service in accordance with the manufacturers' instructions and BS 7593. It is only acceptable to not have undertaken this if the service engineers attendance visit was in between annual services to attend a non-water facing component.

SERVICE/INTERIM WORK ON BOILER <small>delete as appropriate</small>					Date:	
Engineer name:		Company name:				
Telephone N°:		Gas Safe registration N°:				
Max rate	CO	ppm	CO ₂	%	CO/CO ₂	
Min rate	CO	ppm	CO ₂	%	CO/CO ₂	
Where possible, has a flue integrity check been undertaken in accordance with manufacturers' instructions, and readings are correct?"					yes	
Gas rate:	m ³ /h	OR	ft ³ /h			
Were parts fitted? <small>delete as appropriate</small>		Yes	No			
Parts fitted:						
System inhibitor concentration has been checked and appropriate action taken, in accordance with BS 7593 and boiler manufacturers' instructions. *					yes	n/a
Comments:						
Signature:						

*A System inhibitor efficacy test is required on every annual service in accordance with the manufacturers' instructions and BS 7593. It is only acceptable to not have undertaken this if the service engineers attendance visit was in between annual services to attend a non-water facing component.

* All installations in England and Wales must be notified to Local Authority Building Control (LABC) either directly or through a Competent Persons Scheme. A Building Regulations Compliance Certificate will then be issued to the customer.

© Heating and Hotwater Industry Council (HHIC)



www.centralheating.co.uk

Vokèra Warranty Terms and Conditions

Vokèra Ltd offer customers the comfort of a parts and labour warranty repair service subject to the following terms and conditions.

Vokèra Ltd only obligation under the guarantee shall be to repair or replace the faulty appliance at Vokèra Ltd discretion. This will be carried out where a fault arises from defects within the appliance, caused by either material or workmanship of the manufacturer.

1. The boiler must have been installed and commissioned within 12 months of manufacture by a registered Gas Safe (RGII ROI) installer in accordance with the guidelines in the installation and servicing booklet provided with the boiler.
2. This guarantee does not protect malfunction or damage arising from incorrect installation, commissioning or maintenance procedures, as laid out in the installation handbook, inefficient flue system, poor or incorrect electricity, wrong gas supply or pressure, tampering by inexperienced persons and any other cause not directly due to manufacture.
3. Vokèra Ltd cannot accept responsibility for any costs arising from repair or maintenance carried out by any third party.
4. The "Benchmark" commissioning sheet (RGII Installation Certificate, ROI) must be completed by the installer and left with the boiler for reference purpose.
5. The warranty will commence from the date of installation. Without proof of purchase ie an invoice or completed "Benchmark" commissioning sheet (RGII Installation Certificate, ROI), the warranty will commence from the date of manufacture as detailed on the appliance data plate.
6. **To qualify for the full term of warranty, the boiler must be serviced once annually by a Gas Safe Registered Engineer (RGII ROI). Proof of annual service in accordance with the manufacturer's instructions must be provided (e.g. Benchmark Service Record or RGII Service Certificates ROI). If this condition is not met the period of warranty will extend to only 12 months from date of installation.**
7. The Vokèra "parts and labour" warranty is applicable to the boiler only. Vokèra controls and accessories, including all time clocks, room thermostats, smart controls and weather compensation devices are sold subject to a 24 month Return to Base Warranty. No engineer service cover is offered on any Vokèra controls and/or accessories.

By registering your appliance, you will be helping us provide you with the best after sales service in the unlikely event that your boiler requires attention during the guarantee period.

Register online: www.vokera.co.uk (UK) or www.vokera.ie (ROI)

If the boiler suffers a mechanical or an electrical breakdown or you require an annual service, please contact our Customer Care Centre on:

UK: 01274 866100

ROI: 056 7755057

Our normal working hours, excluding Bank holidays are:

8.15am - 5.00pm Monday to Friday (ROI, 8.30am - 5.00pm Monday to Thursday, 8.30am - 4.00pm Friday)

8.00am - 12.00pm Saturday (UK only)

We will arrange for an engineer or appointed agent, to inspect and repair, or where in our sole opinion repair is not economic, arrange to replace the boiler.

8. Health & Safety:

- a. Engineers will only attend to boiler products where it is considered by the engineer that the installation does not pose a risk to health and safety.
- b. A permanently fixed access ladder must service installations in lofts or attics. Adequate lighting and permanently fixed flooring must also be available.
- c. Cupboard installations must provide minimum working clearances as detailed in the installation instructions. Vokèra will not accept responsibility for the removal of cupboards, kitchen units or trims in order to gain access for repairs.

9. Warranty does not apply:

- a. If the boiler is removed from its place of installation without our prior consent.
- b. To any defect, damage or breakdown caused by inadequate servicing of the boiler or by deliberate action, accident, misuse or third party interference including modification or an attempted repair which does not fully comply with industry standards.
- c. To any defect, damage or breakdown caused by the design, installation and maintenance of the central heating system.
- d. To de-scaling or other work required as a result of hard water scale deposits or from damage caused by aggressive water or sludge resulting from corrosion. Indications that such work may be required include a noisy boiler, cold spots on radiators, sludge in pipes and poor circulation of the central heating system.
- e. If the claim/contact procedure set out in section 6 is not adhered to.
- f. To any other costs or expenses caused by or arising as a result of the breakdown of a Vokèra Boiler.
- g. To any costs incurred during delays in fixing reported faults.

10. We reserve the right to a charge a callout fee where:

- a. There is no completed "Benchmark" commissioning sheet or equivalent control document present.
- b. There is incomplete or no service record(s) for each and every year the boiler has been installed.
- c. A fault cannot be found.
- d. The breakdown or fault has been caused by an event, which is excluded from the warranty – see section 9.
- e. Failure to cancel an agreed appointment prior to our engineers visit.
- f. The boiler is outside the period of warranty or the conditions of the warranty have not been met.

- 11. If we fit replacement parts or replace a boiler it will not extend the period of the warranty. All replaced parts or boilers will become the property of Vokèra Ltd.
- 12. The warranty applies only where a Vokèra boiler has been installed in a domestic dwelling in the United Kingdom, Northern Ireland or Republic of Ireland, to provide heat and/or hot water to the central heating system.
- 13. Vokèra Ltd warranty is offered in addition to the rights provided to a consumer by law. Details of these rights can be obtained from a Trading Standards Authority or a Citizen Advice Bureaux.

Contact Us:- Customer Care Centre Tel: 01274 866100 (UK), 056 7755057 (ROI)

UK: Vokèra Ltd, Customer Care, Stubs Beck Lane, West 26 Business Park, Whitehall Road, Cleckheaton, BD19 4TT

ROI: Vokèra Ltd, Customer Care, West Court, Callan, Co Kilkenny, Ireland , R95 PW40

Email: service@vokera.co.uk (UK), eire-service@vokera.co.uk (ROI)



RANGE RATED - EN 15502-1

The max CH input of this boiler has been adjusted to _____ kW,
equivalent to _____ rpm max CH fan speed.

Date ___ / ___ / ___

Signature _____

Boiler serial number

Registered address:

Vokèra Ltd
Borderlake House
Unit 7 Riverside Industrial Estate
London Colney
Herts AL2 1HG

www.vokera.co.uk
www.vokera.ie

Sales, General Enquires

T 0844 391 0999
F 0844 391 0998

Vokèra Ireland
West Court, Callan
Co Kilkenny
T 056 7755057
F 056 7755060

Vokèra Limited reserve the right to change
specification without prior notice
Consumers statutory rights are not affected.

Company Reg No: 1047779